

Glass Canopy Wall-Mount Hood

RH36WC60G S



LCD Electronic Controls

An array of versatile options with easy-to-read blue displays, including a convenient kitchen timer, fan-speed selection and a delayed power-off option. The hoods also feature sensors that will turn them on automatically if they sense heat or smoke.



Dual-Centrifugal Fans

Move air quietly and quickly—up to 600 cu.ft. of air per minute.



Stainless Steel Filters

Dishwasher safe for easy cleaning.



Halogen Lighting

For bright illumination of the cooktop surface.

36" GLASS CANOPY WALL-MOUNT HOOD

Features

Nominal Width	36"
Installation Type	Wall Mount
Style	Stainless Steel/ Glass Canopy
Intelligent Heat Sensor	Yes
Air Discharge	Vertical
Air Delivery (CFM)	600
Blower Type	Dual Centrifugal
Electronic Controls with LCD Display	Yes
Fan Speeds	4
Sound Level (dBA)	73.8
Dual Halogen Lights	Yes
Dishwasher Safe Stainless Steel Filters	Yes
Exhaust Duct	Convertible*
Duct Required	8" Round

Accessories

Charcoal Filter – PN# RHCFW60GS	Optional
Duct-Free Kit (Single Pack) – PN# RHDFW60GS	Optional

Specifications

Color –	
Stainless Steel	S
Product Dimensions –	
Height (With One Cover) (With Flue Extension)	29-7/16" min. 30-1/8" min. 54-9/16" max.
Width	35-7/8"
Depth	19-11/16"
Voltage Rating	120V/60Hz/15A
Connected Load (kW Rating) @ 120 Volts†	0.474
Amps @ 120 Volts	3.8
Shipping Weight (Approx.)	67 Lbs.
Sones Rating	9.0

* Ventilation is convertible to be either ducted outside, or recirculated inside requiring no ducting. (Recirculated option requires use of optional Duct-Free Kit.)

† For use on adequately wired 120V, dedicated circuit having 2-wire service with a separate ground wire. Appliance must be grounded for safe operation.

NOTE: Always consult local and national electric codes. Check local building codes for installation requirements, as they may vary per locale. Refer to Product Installation Guide for detailed installation instructions on the web at electroluxappliances.com.

Specifications subject to change.

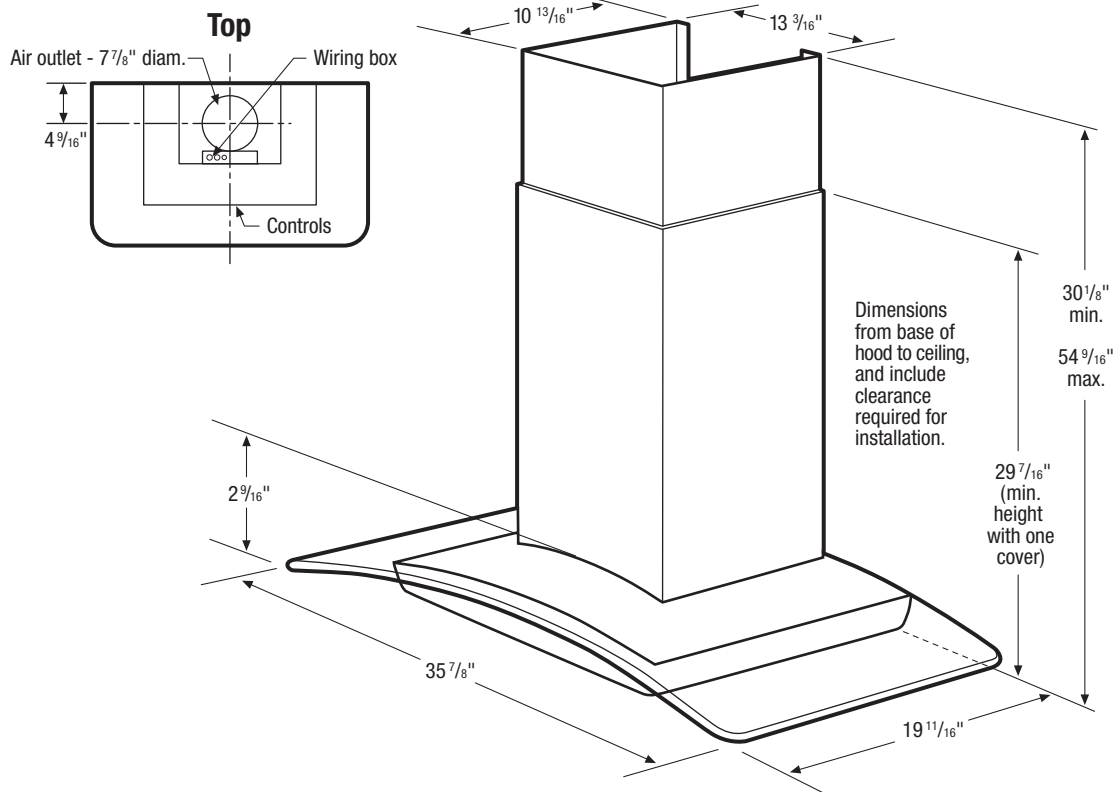

36" Glass Canopy Wall-Mount Hood Specifications

- Product Weight – 64 Lbs.
- Wall-Mount Installation
- Ventilation system is preset to exhaust air outside. If outside ducting is not possible, optional Duct-Free Kit (PN# RHDFW60GS) is available to convert ventilation to allow air to recirculate inside. (Refer to Ducted Option Specifications for outside ventilation.)
- Sones Rating – 9.0
- Voltage Rating – 120V/60 Hz/15 Amps
- Connected Load (kW Rating) @ 120 Volts = 0.474kW (For use on adequately wired 120V, dedicated circuit having 2-wire service with a separate ground wire. Appliance must be grounded for safe operation.)
- Amps @ 120 Volts = 3.8 Amps
- Always consult local and national electric codes. Check local building codes for installation requirements, as they may vary per locale.
- Minimum installation height allowed from bottom of hood to cooking surface is 24" - 30" for electric and 30" for gas. (NOT more than 36" recommended.)
- To prepare mounting surface, adequate structure and support must be provided, capable of supporting 100 lbs.

Ducted Option Specifications

- For outside ventilation.
- Exhaust Duct Required – 8" round
- For most efficient airflow exhaust, use a straight run or as few elbows as possible.
- Use metallic flex ducting only to connect rigid duct directly to transitions (if allowed by code).
- Thermal breaks such as short section of nonmetallic duct, should be used in areas of extreme cold.
- Cold weather installations should have additional backdraft damper installed.
- Refer to installation instructions on web for detailed exhaust duct preparation and converting vent blower system for recirculating inside.

Note: For planning purposes only. Refer to Product Installation Guide on the web at electroluxappliances.com for detailed instructions.

Optional Accessories

- Charcoal Filter – (PN# RHCFW60GS).
- Duct-Free Kit (Single Pack) – (PN# RHDFW60GS).