



T375.128 Bath/Shower Trim Shown

GENERAL DESCRIPTION:

TRIM KIT

FloWise water saving showerhead offers 40% water savings at maximum 1.5gpm/5.7L/min. flow rate. Metal slip-on diverter spout. Available with lever or metal lever handle. Available in Bath/Shower and Shower Only combinations.

ROUGH VALVE BODY

Cast brass body, washerless ceramic disc valve cartridge with back-to-back capability, integrated check valves and hot limit safety stop. Cycles from "off" to "cold" to "hot". Pressure balancing cartridge maintains constant output temperature in response to changes in relative hot and cold supply pressure. 1/2" inlets and outlets (choice of direct sweat, threaded, or PEX). Available with screwdriver stops. Rough-in plaster guard designed for use as thin-wall mounting adaptor.



SUGGESTED SPECIFICATION:

Bath/shower fitting shall feature water saving showerhead with Max. 1.5gpm/5.7L/min. flow rate. Shall feature a cast brass body. Shall feature ceramic disc valve cartridge which is capable of back-to-back installation. Fitting shall be equipped with pressure balancing cartridge engineered to eliminate cross flow and avoid failure due to mineral deposits. Shall also feature hot limit safety stop. Fitting shall be: Rough Valve Body - American Standard Model # R11____, Trim Kit - American Standard Model # T37____.

MODEL NUMBER:

TRIM KITS:

- T375.128 Colony BATH/SHOWER Trim Kit**
Lever Handle. FloWise Showerhead. LESS Valve Body.
- T375.248 Colony BATH/SHOWER Trim Kit**
Metal Lever Handle. FloWise Showerhead. LESS Valve Body.
- T372.128 Colony SHOWER ONLY Trim Kit**
Lever Handle. FloWise Showerhead. LESS Valve Body.
- T372.248 Colony SHOWER ONLY Trim Kit**
Metal Lever Handle. FloWise Showerhead. LESS Valve Body.

ROUGH VALVES:

- R110 Pressure Balance Rough Valve Body only**
Direct sweat inlets/outlets. LESS trim.
- R110SS Pressure Balance Rough Valve Body only with Screwdriver stops**
Direct sweat inlets/outlets. Screwdriver stops. LESS trim.
- R115 Pressure Balance Rough Valve Body only**
Female thread inlets/outlets. LESS trim.
- R115SS Pressure Balance Rough Valve Body only with Screwdriver stops**
Female thread inlets/outlets. Screwdriver stops. LESS trim.
- R117 Pressure Balance Rough Valve Body only**
PEX inlets/Direct sweat outlets. LESS trim.
- R117SS Pressure Balance Rough Valve Body only with Screwdriver stops**
PEX inlets/Direct sweat outlets. Screwdriver stops. LESS trim.

PRODUCT FEATURES:

FloWise Water Saving Showerhead: Saves 40% in water usage. Max. 1.5gpm/5.7L/min. flow rate.

Cast Brass Valve Body: Durable - Quality that will last a lifetime. Ideal material for prolonged contact with water.

Ceramic Disc Valve Cartridge: Assures a lifetime of drip-free performance. Allows easy fine tuning of temperature (125° handle rotation from off to hot).

Pressure Balancing Valve Cartridge: Maintains constant output temperature in response to changes in relative hot and cold supply pressure. Diaphragm system with integrated check valves engineered to eliminate cross flow. Avoids failure due to mineral deposits - ideal for use in hard water.

Back-to-Back Capability: Hot and cold can be reversed quickly and easily.

Adjustable Hot Limit Safety Stop: Limits the amount of hot water allowed to mix with cold. Reduces the risk of accidental scalding.

Exclusive Plaster Guard: Plaster guard is designed to protect valve during installation and serve as a mounting plate for thin-wall installations. 2 piece design allows valve to be tested prior to trim installation.

Wide Rough-in Range: From 1-5/8" to 3-1/4".

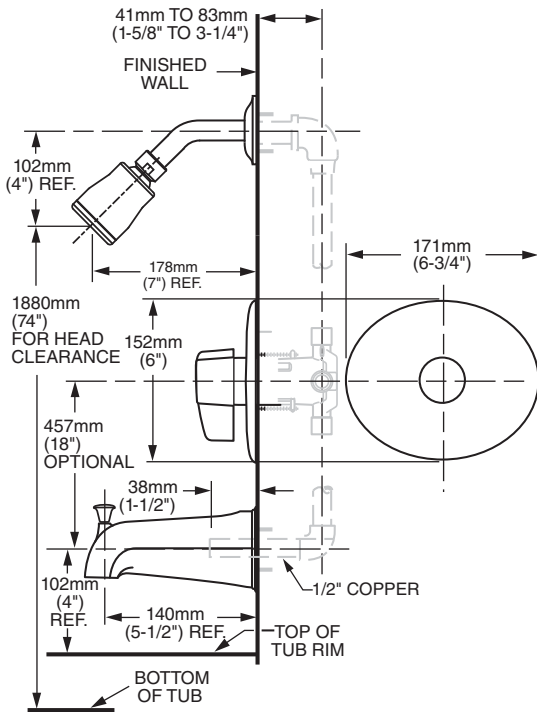

VALVE BODY OPTIONS

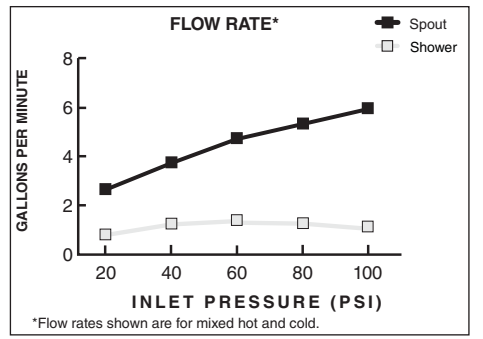
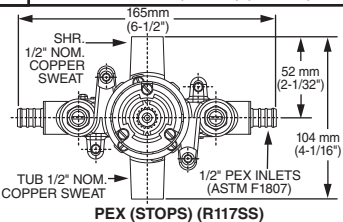
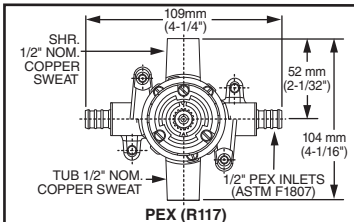
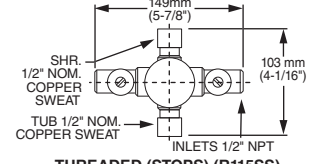
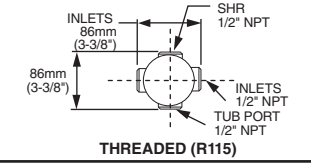
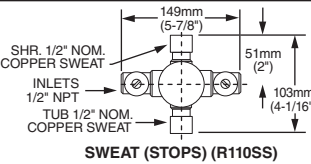
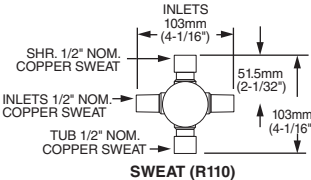

CODES AND STANDARDS

These products meet or exceed the following codes and standards:

- ASSE 1016
- ASME A112.18.1
- CSA B 125



Meets the American Disabilities Act Guidelines and ANSI A117.1 Requirements for the physically challenged.

Modifications

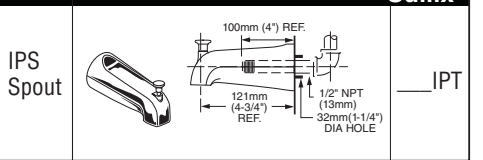

Parts Suffix*

IPS Spout IPT

*To modify a product, add suffix after the 4th digit (ex. T064ITP502.002)

TRIM KITS *	Product Number	Description		Finish Options	
				Polished	Chrome
				002	
T375.128	Bath/Shower Trim Kit. Lever Handle. FloWise Showerhead. LESS Valve Body.				
T375.248	Bath/Shower Trim Kit. Metal Lever Handle. FloWise Showerhead. LESS Valve Body.				
T372.128	Shower Only Trim Kit. Lever Handle. FloWise Showerhead. LESS Valve Body.				
T372.248	Shower Only Trim Kit. Metal Lever Handle. FloWise Showerhead. LESS Valve Body.				

ROUGH VALVE BODIES	Product Number	Description
	R110	Rough Valve Body less trim. Direct Sweat inlets/outlets.
	R110SS	Rough Valve Body less trim. Direct Sweat inlets/outlets with Screwdriver Stops.
	R115	Rough Valve Body less trim. Female Thread inlets/outlets.
	R115SS	Rough Valve Body less trim. Female Thread inlets/outlets with Screwdriver Stops.
	R117	Rough Valve Body less trim. PEX inlets/ Direct Sweat outlets.
	R117SS	Rough Valve Body less trim. PEX inlets/ Direct Sweat outlets with Screwdriver Stops.

* TRIM & ROUGH MUST BE ORDERED SEPARATELY.