

There is more than 1 version of this model.
Page down to identify the version you have.

SINK DESCRIPTION

- Manufactured of 18 gauge stainless steel
- Single bowl is 16" x 14" x 11" deep
- Has one 3-1/2" diameter recessed drain opening
- Soundshield undercoating maximizes sound deadening and inhibits condensation
- Made in USA
- Includes all necessary mounting hardware

CUT OUT DIMENSIONS (For sinks manufactured after 9/1/2016)

- Cut out dimensions are 18-7/8" x 16-7/8", with a 3/8" corner radius. A tolerance of plus or minus 1/16" is acceptable

STANDARDS

- Third party certified to ASME A112.19.3M/CSA B45.4 and all applicable specifications referenced therein

WARRANTY

- Warranted for five years against material or manufacturing defects

Specifications

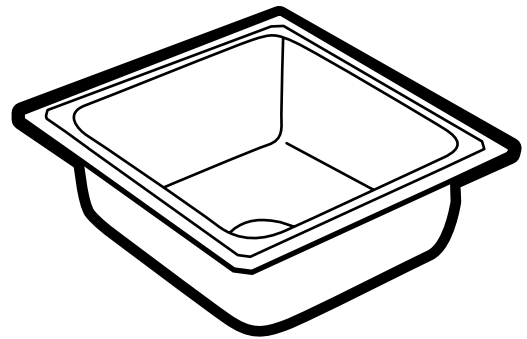

**Single Bowl Kitchen Sink
Model: 22124
(H-1618)**

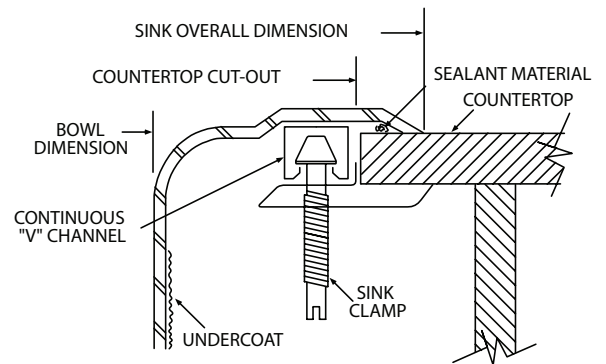
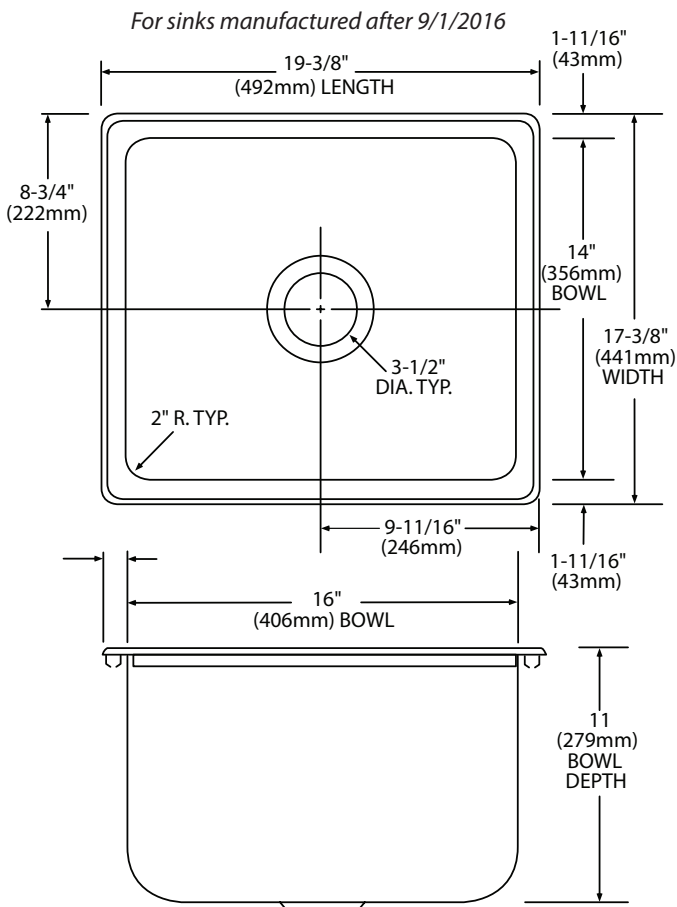

Installation Detail

CRITICAL DIMENSIONS
(DO NOT SCALE)

SINK DESCRIPTION

- Manufactured of 18 gauge stainless steel
- Single bowl is 16" x 14" x 11" deep
- Has one 3-1/2" diameter recessed drain opening
- Soundshield undercoating maximizes sound deadening and inhibits condensation
- Made in USA
- Includes all necessary mounting hardware

CUT OUT DIMENSIONS (For sinks manufactured before 9/1/2016)

- Cut out dimensions are 17-1/8" x 15-1/8", with a 3/8" corner radius. A tolerance of plus or minus 1/16" is acceptable

STANDARDS

- Third party certified to ASME A112.19.3M/CSA B45.4 and all applicable specifications referenced therein

WARRANTY

- Warranted for five years against material or manufacturing defects

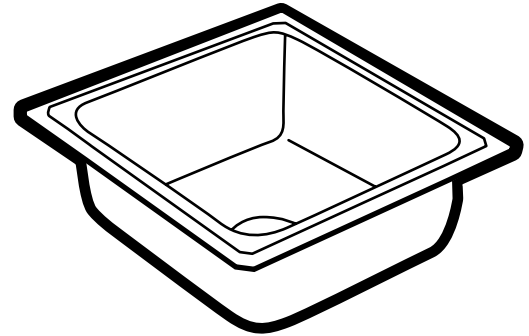

Single Bowl Kitchen Sink
Model: 22124
(H-1618)

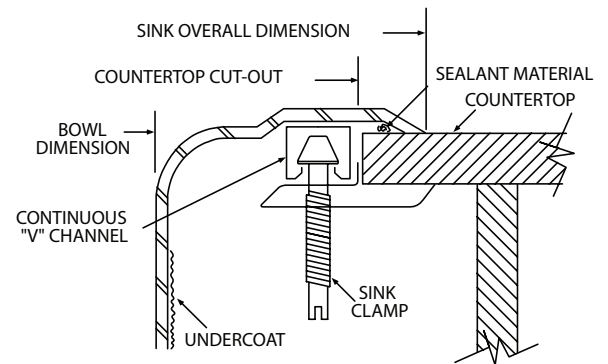
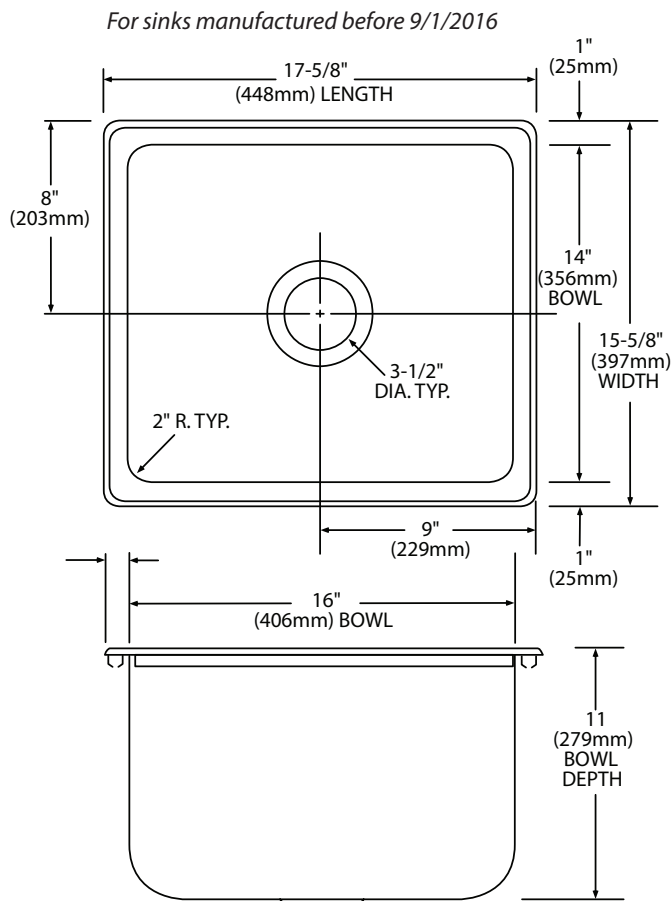

Installation Detail

CRITICAL DIMENSIONS

(DO NOT SCALE)