

### Features

- Vitreous china.
- Under-mount
- With overflow.
- Includes 1193643 clamp assembly.
- Available with KOHLER Artist Editions designs
- 19-1/4" (489 mm) x 16-1/4" (413 mm)

### Recommended Accessories

K-8998 P-Trap

### Components

Additional included component/s: Basin Clamp Assembly.



ADA CSA B651

### Codes/Standards











ASME A112.19.2/CSA B45.1  
ADA  
ICC/ANSI A117.1  
CSA B651

### KOHLER® One-Year Limited Warranty

See website for detailed warranty information.

### Available Color/Finishes

*Color tiles intended for reference only.*

Color	Code	Description
	0	White
	96	Biscuit
	47	Almond
	NY	Dune
	95	Ice™ Grey
	G9	Sandbar
	33	Mexican Sand™
	K4	Cashmere
	58	Thunder™ Grey
	7	Black Black™

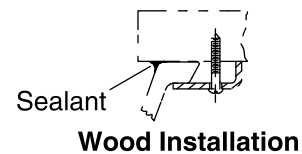
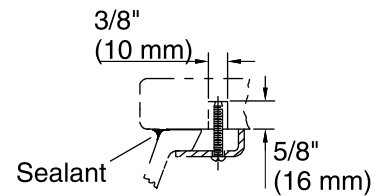
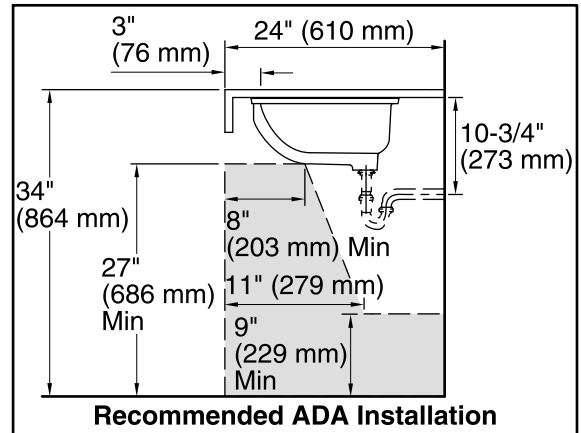
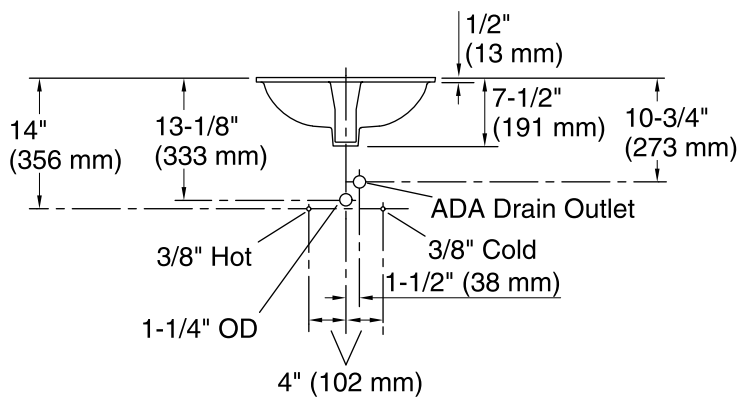
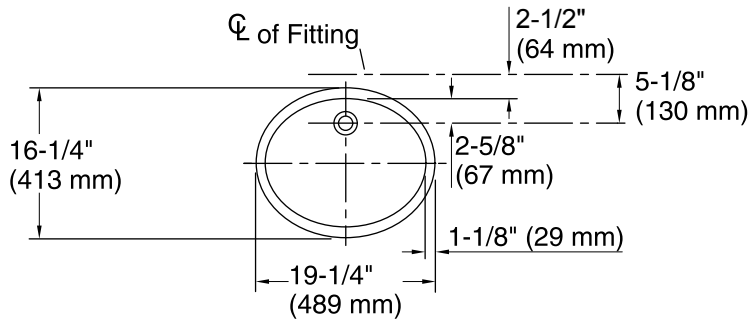

## Technical Information

All product dimensions are nominal.

Installation:	Under-mount
Bowl area	Length: 17" (432 mm) Width: 14" (356 mm) With overflow: Yes Water depth: 4" (102 mm)
Bowl area	With overflow: Yes
Drain hole:	1-3/4" (44 mm)
Template:	1151011-7, required, not included

## Notes

Install this product according to the installation instructions.

**NOTICE:** Countertop manufacturer or cutter must use the current product template available at [www.kohler.com](http://www.kohler.com), or by calling 1-800-4KOHLER. Kohler Co. is not responsible for cutout errors when the incorrect cutout template is used.

ADA, CSA B651 compliant when installed to the specific requirements of these regulations.