

## DESCRIPTION

The Halo RA56 LED Adjustable Gimbal series are retrofit LED Modules for 5" and 6" aperture recessed downlights. The RA56 gimbals feature adjustment of 35-degree tilt and up to 360-degree rotation. In addition the RA56 gimbals offer selection of narrow flood (NFL) and very wide flood (VWFL) models for beam distributions suitable for accent, task, grazing and general area lighting. The RA56 integral LED 120V driver is dimmable with most leading edge and trailing edge phase control dimmers.

Catalog #		Type
Project		
Comments		Date
Prepared by		

## SPECIFICATION FEATURES

### MECHANICAL

- Module includes LED, heat sink, reflector, lens optic, baffle reveal, and trim ring
- Trim ring is sized to conceal 5" and 6" housing openings, and features a visually appealing graduated step design
- Durable die-cast aluminum construction
- Integrated heat sink design conducts heat away from the LED keeping the junction temperatures below specified maximums, even when installed in insulated ceiling environments
- Halo matte white paint finish
- 35-degree tilt
- Up to 360-degree rotation

### Optics

#### NARROW FLOOD - NFL

- Precision acrylic lens
- Optical design creates a clean, uniform 25-degree beam distribution

#### VERY WIDE FLOOD - VWFL

- Impact-resistant polycarbonate
- Convex form for lamp-like appearance
- Diffusing, wide beam for even illumination

### MOUNTING

#### Torsion Spring Brackets

- Pre-installed precision formed torsion spring brackets secure torsion springs and adjust to fit 5" or 6" compatible housings

#### 5" & 6" Friction Blade Kit

- Precision formed friction blades kit included (2 - 5" and 2 - 6")
- Provide alternative to torsion springs for retrofit in 5" and 6" housings without torsion spring mounting tabs.
- Friction blade design allows the RL560 to be installed in any position within the housing aperture (360 degrees).
- Replacement Kit: RL56CLIP

#### Housing Compatibility

See Housing Compatibility

### LED

- Color Temperature (CCT) Options: 2700K, 3000K
- Color Rendering Index (CRI) 92
- LED is a chip on board design consisting of a multiple LED package with proximity phosphor coating to create one virtual white light source for a productive "cone of light"

### ELECTRICAL

#### Power Connections

- LED connector is a non-screw base luminaire disconnect offering easy installation with the matching Halo 5" H550 Series and 6" H750 and H2750 Series LED housings.
- LED Connector meets high-efficacy luminaire requirements for a non-screw base socket, and where required to qualify as a high-efficacy luminaire. (California Title-24)
- The included E26 medium screw-base Edison adapter provides easy retrofit of incandescent housings (see Housing Compatibility).

#### Ground Connection

- Separate grounding cable included on the module for attachment to the housing during installation.

#### LED Driver

- Dimmable driver is a 120 Volt, high efficiency, electronic power supply providing DC power to the LED.
- Driver meets FCC EMI/RFI Consumer Level limits for use in residential and commercial installations.
- Driver features high power factor, low THD, and has integral thermal protection in the event of over temperature or internal failure.
- Driver mounts externally to the module, allowing future replacement, if needed.

### Dimming

- The Halo RA56 LED is designed for dimming capability to 10% in normal operation with standard 120V leading edge (LE) and trailing edge (TE) phase control dimmers.
- The LED module may also dim to 5% nominal using dimmers with low end trim adjustment. (Consult dimmer manufacturer for dimmer details. Note, some dimmers require a neutral in the wallbox.)

### Warranty

Cooper Lighting provides a five year limited warranty on RA56 LED.

### Compliance Labels

- UL/cUL Listed 1598 Luminaire (with listed Halo housings)
- UL Classified (with other housings - see Housing Compatibility)
- UL/cUL Listed for Damp Location
- May be installed in housings in direct contact with air permeable insulation\*\* and combustible material

### Qualification

- ENERGY STAR® qualified residential and commercial\*
- Can be used for State of California Title 24 high efficacy luminaire compliance\*
- Can be used for Washington State Energy Code (WSEC) and International Energy Conservation Code (IECC) high efficacy luminaire Compliance

### IC (Insulated Ceiling)

Listed UL/cUL 1598 with compatible housings, may be used to meet insulated ceiling\*\* requirements such as:

- Washington State Energy Code (WSEC)
- International Energy Conservation Code (IECC)
- New York State Energy Conservation Code (NY-ECCC)
- State of California Title 24 "Recessed Luminaires in Insulated Ceilings."



**RA56 LED  
Very Wide Flood  
(VWFL)**



**RA56 LED  
Narrow Flood  
(NFL)**

**5-Inch / 6-Inch  
Adjustable Gimbals  
All-Purpose Recessed  
Retrofit Modules**

**FOR USE IN INSULATED  
CEILING AND  
NON-INSULATED  
CEILING RATED HOUSINGS**

**HIGH EFFICACY LED  
WITH INTEGRAL DRIVER -  
DIMMABLE**

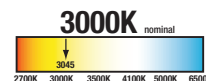
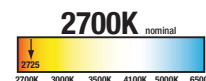

\*Qualified and compliant. Refer to ENERGY STAR® Qualified Products List and CEC (T24) Appliance Database for listings.

\*\*Not for use with housings in direct contact with spray foam insulation.

**ENERGY DATA**

Minimum Starting Temp: -30°C (-22°F)
EM/RFI: FCC Title 47 CFR, Part 15, Class B (Consumer)
Sound Rating: Class A standards
Input Voltage: 120V
Power Factor: >0.90
Input Frequency: 50/60Hz
THD: <20%
Input Power: 10W
Input Current: 85mA

Driver-Safety Agency Approvals:

- UL60950-1 Recognized
- LPS output
- UL8750 Compliant

Maximum IC (Insulated Ceiling) Ambient Continuous Operating Temperature: 25°C (77°F)

Maximum Non-IC (NON-Insulated Ceiling) Ambient Continuous Operating Temperature 40°C (104°F)

**DIMENSIONS**

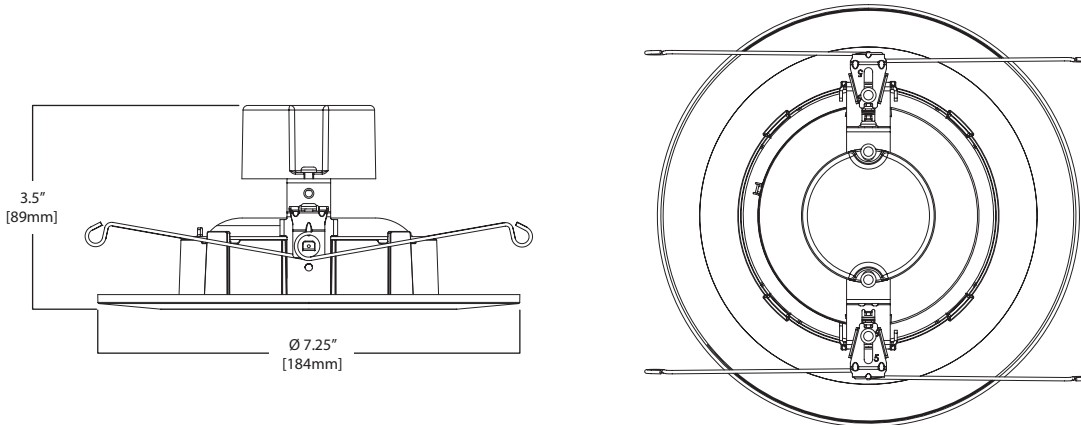

**LIGHTING FACTS**

**RA5606927WH**

2700K Source  
VWFL Beam

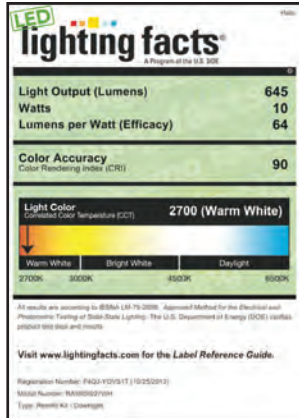

**RA5606930WH**

3000K Source  
VWFL Beam

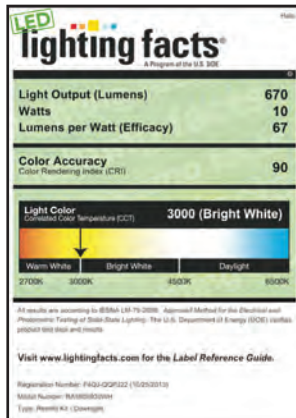

**RA5606927NFLWH**

2700K Source  
NFL Beam

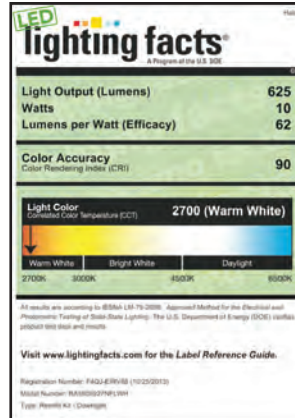

**RA5606930NFLWH**

3000K Source  
NFL Beam

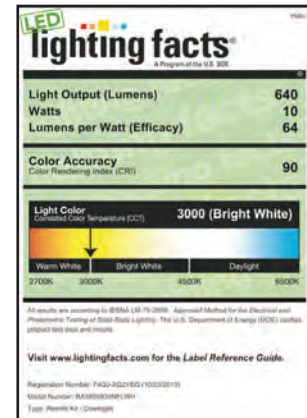

For further information refer to the Lighting Facts website at <http://lightingfacts.com/>.

**ORDERING INFORMATION**

**SAMPLE NUMBER:** RA5606930WH

Complete unit includes RA56 LED and a 5" or 6" compatible housing, ordered separately (see: Housing Compatibility).

RA56 Series	Accessory (order separately)
<p><b>Very Wide Flood - VWFL Models</b></p> <p><b>RA5606927WH</b>= 5" / 6" LED Adjustable Gimbal, 90CRI, 2700K, White, Very Wide Flood</p> <p><b>RA5606930WH</b>= 5" / 6" LED Adjustable Gimbal, 90CRI, 3000K, White, Very Wide Flood</p> <p><b>Narrow Flood - NFL Models</b></p> <p><b>RA5606927NFLWH</b>= 5" / 6" LED Adjustable Gimbal, 90CRI, 2700K, White, Narrow Flood</p> <p><b>RA5606930NFLWH</b>= 5" / 6" LED Adjustable Gimbal, 90CRI, 3000K, White, Narrow Flood</p>	<p><b>HE26LED</b>=Replacement screw base adapter (one included with unit)</p> <p><b>RL56CLIP</b>=Replacement 5" / 6" Friction Blade Kit (one included with unit)</p> <p><b>OT400P</b>=Oversize Flat White Metal trim ring 6" I.D. x 9-1/4" O.D. (ring slips behind RA56 ring, in stepped configuration)</p> <p><b>OT403P</b>=Oversize White Plastic trim ring 6" I.D. x 8" O.D. (ring slips behind RA56 ring, in stepped configuration)</p> <p><b>TRM690WH</b>=Oversize Matte White Metal trim ring. Designed for RA56 ring to inset into oversize ring for an even (non-stepped) trim surface</p>

## HOUSING COMPATIBILITY

## UL Listed

## Compatible Halo LED Housings with LED luminaire connector (high-efficacy compliant)

HALO	Recessed Can Size	Catalog Number	Description
	5"		H550ICAT
H550RICAT			5" LED, Insulated Ceiling, AIR-TITE, Remodel Housing
6"		H750ICAT	6" LED, Insulated Ceiling, AIR-TITE, New Construction Housing
		H750RICAT	6" LED, Insulated Ceiling, AIR-TITE, Remodel Housing
		H750T	6" LED, Non-IC, AIR-TITE, New Construction Housing
		H750RINTD010	6" LED, Non-IC, AIR-TITE, Remodel International Housing
		H750TCP	6" LED, Non-IC, New Construction/Remodel Chicago Plenum Housing
		H2750ICAT	6" LED, Shallow, Insulated Ceiling, AIR-TITE, New Construction Housing

## UL Listed

## Compatible Halo Incandescent E26 Screwbase Housings

HALO	5"	H5ICAT	5" Insulated Ceiling, AIR-TITE New Construction Housing
		H5RICAT	5" Insulated Ceiling, AIR-TITE Remodel Housing
		H5T	5" Non-IC, New Construction Housing
		H5RT	5" Non-IC, Remodel Housing
		H5TM	5" Non-IC, New Construction Housing (metric version - Canada)
		H25ICAT	5" Shallow, Insulated Ceiling, AIR-TITE New Construction
	6"	H7ICAT	6" Insulated Ceiling, AIR-TITE New Construction Housing
		H7RICAT	6" Insulated Ceiling, AIR-TITE Remodel Housing
		H7ICT	6" Insulated Ceiling, New Construction Housing
		H7RICT	6" Insulated Ceiling, Remodel Housing
		H7ICATNB	6" Insulated Ceiling, AIR-TITE New Construction Housing, No Socket Bracket
		H7ICTNB	6" Insulated Ceiling, New Construction Housing, No Socket Bracket
		H7T	6" Non-IC, New Construction Housing
		H7RT	6" Non-IC, Remodel Housing
		H7TNB	6" Non-IC, New Construction Housing, No Socket Bracket
		H7TCP	6" Non-IC, Chicago Plenum, New Construction/Remodel Housing
		H7UICT	6" Insulated Ceiling, Universal New Construction Housing
		H7UICAT	6" Insulated Ceiling, Universal, AIR-TITE, New Construction Housing
		H27ICAT	6" Shallow, Insulated Ceiling, AIR-TITE New Construction Housing
		H27RICAT	6" Shallow, Insulated Ceiling, AIR-TITE Remodel Housing
		H27ICT	6" Shallow, Insulated Ceiling, New Construction Housing
		H27RICT	6" Shallow, Insulated Ceiling, Remodel Housing
		H27T	6" Shallow, Non-IC, New Construction Housing
		H27RT	6" Shallow, Non-IC, Remodel Housing

## HOUSINGS - Halo and All-Pro UL Listed Compatibility (continued)

## Halo LED Retrofit Enclosures

<b>HALO</b>	<b>6"</b>	ML7BXRFK	6" Retrofit Enclosure, Non-IC, BX Whip
		ML7E26RFK	6" Retrofit Enclosure, Non-IC, E26 Screw base Interface

## Compatible All-Pro Incandescent E26 Screwbase Housings

	Recessed Can Size	Catalog Number	Description
<b>All-Pro</b>	<b>5"</b>	EI500AT	5" Insulated Ceiling, AIR-TITE New Construction Housing
		EI500RAT	5" Insulated Ceiling, AIR-TITE Remodel Housing
		ET500	5" Non-IC, New Construction Housing
		ET500R	5" Non-IC, Remodel Housing
	<b>6"</b>	EI700AT	6" Insulated Ceiling, AIR-TITE New Construction Housing
		EI700RAT	6" Insulated Ceiling, AIR-TITE Remodel Housing
		EI700	6" Insulated Ceiling, New Construction Housing
		EI700R	6" Insulated Ceiling, Remodel Housing
		EI700ATNB	6" Insulated Ceiling, AIR-TITE New Construction Housing, No Socket Bracket
		EI700NB	6" Insulated Ceiling, New Construction Housing, No Socket Bracket
		EI700U	6" Insulated Ceiling, Universal New Construction Housing
		EI700UAT	6" Insulated Ceiling, Universal, AIR-TITE, New Construction Housing
		ET700	6" Non-IC, New Construction Housing
		ET700R	6" Non-IC, Remodel Housing
		EI2700AT	6" Shallow, Insulated Ceiling, AIR-TITE New Construction Housing
		EI2700	6" Shallow, Insulated Ceiling, New Construction Housing
		EI2700R	6" Shallow, Insulated Ceiling, AIR-TITE Remodel Housing
		ET2700	6" Shallow, Non-IC, New Construction Housing
		ET2700R	6" Shallow, Non-IC, Remodel Housing

## HOUSINGS - UL Classified

For retrofit in the following 5" and 6" recessed housings:

<b>Juno®</b>	IC22, IC22R, IC22W, IC22S, IC23, IC23W, IC21, IC21R, IC2, TC2, TC2R, IC20, IC20R, IC25, IC25R, IC25W, IC25S, TC20, TC20R
<b>Capri Lighting</b>	CR1, PR1, QL1, R9ASIC, R5*
<b>Lightolier®</b>	1104ICS*, 1104ICR*, 1104SIC*, 1104SICR*, 1004ICS*, 1004ICR*, 1004SIC*, 1004SICR*
	1104ICX - Requires installation of ML7RAB retrofit adapter band accessory (not included).
<b>Progress® Lighting</b>	P87-AT*, P86TG
<b>Lithonia Lighting®</b>	L7X, L7XP
<b>Thomas® Lighting</b>	PS1, R9ASIC/PS9RM
<b>Prescolite®</b>	IBXS
<b>Commercial Electric™</b>	C7ICA (H3), H18
<b>Elco Lighting®</b>	(HL7ICA) EL7ICA

\*Requires replacement of torsion springs with included friction clips (accessory replacement kit: RL56CLIP).

Juno®, Capri Lighting, Lightolier®, Lithonia Lighting®, Thomas® Lighting, Elco Lighting®, Progress® Lighting, Prescolite® and Commercial Electric™ and their product brand names, where identified above, are tradenames or trademarks of each respective company and Cooper Lighting makes no representations on these trademarks.

PHOTOMETRY

**RA5606927WH**

Reflector Beam Angle = VWFL Beam  
(Very Wide Flood)

CCT = 2700K  
Spacing Criteria = 1.23  
Lumens per Watt = 64.5 Lm/W  
Test No. P121913  
Test Model: RA5606927WH

Cone of Light Footcandles 0 deg Aiming Angle Horizontal Illuminance on Floor				
Distance to Illuminated Plane	Initial Nadir Footcandles	Beam (ft.)		CB
		L Length	W Width	
5.5'	9.2	6.6	6.6	
7'	5.7	8.4	8.4	
8'	4.3	9.8	9.8	
9'	3.4	11	11	
10'	2.8	12.2	12.2	

Cone of Light Footcandles 35 deg Aiming Angle Vertical Illuminance on Wall				
Distance to Illuminated Plane	Initial Nadir Footcandles	Beam (ft.)		CB
		L Length	W Width	
2'	43.7	2.1	2.4	2.9
3'	19.4	3.1	3.8	4.3
4'	10.9	4.1	5	5.7
5'	7	5.2	6.2	7.1
6'	4.9	6.4	7.6	8.6
8'	2.7	8.4	10.2	11.4
10'	1.7	10.7	12.6	14.3

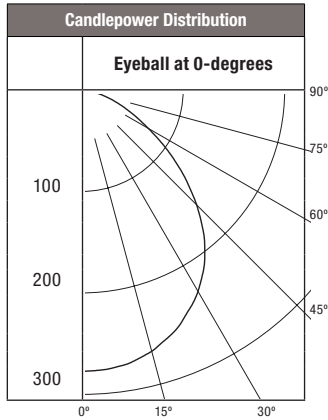

Candela Distribution	
Degrees Vertical	Candela
0*	277
5	276
15	267
25	244
35	211
45	160
55	103
65	55
75	23
85	4
90	0

Luminance (Average Candela/M²)	
Degree	Avg. 0° Luminance
45	31342
55	24818
65	17873
75	12507
85	6032

Zonal Lumen Summary		
Zone	Lumens	% Fixture
0-30	214	33.2
0-40	345	53.5
0-60	560	86.9
0-90	645	100

\*CBCP

**RA5606930WH**

Reflector Beam Angle = VWFL Beam  
(Very Wide Flood)

CCT = 3000K  
Spacing Criteria = 1.23  
Lumens per Watt = 67 Lm/W  
Test No. P121915  
Test Model: RA5606930WH

Cone of Light Footcandles 0 deg Aiming Angle Horizontal Illuminance on Floor				
Distance to Illuminated Plane	Initial Nadir Footcandles	Beam (ft.)		CB
		L Length	W Width	
5.5'	9.5	6.6	6.6	
7'	5.9	8.4	8.4	
8'	4.5	9.8	9.8	
9'	3.6	11	11	
10'	2.9	12.2	12.2	

Cone of Light Footcandles 35 deg Aiming Angle Vertical Illuminance on Wall				
Distance to Illuminated Plane	Initial Nadir Footcandles	Beam (ft.)		CB
		L Length	W Width	
2'	45.4	2.1	2.4	2.9
3'	20.2	3.1	3.8	4.3
4'	11.3	4.1	5	5.7
5'	7.3	5.2	6.2	7.1
6'	5	6.4	7.6	8.6
8'	2.8	8.4	10.2	11.4
10'	1.8	10.7	12.6	14.3

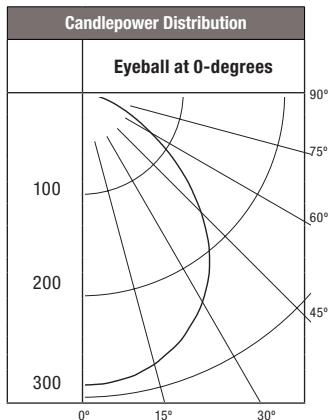

Candela Distribution	
Degrees Vertical	Candela
0*	288
5	287
15	277
25	253
35	219
45	166
55	107
65	57
75	24
85	4
90	0

Luminance (Average Candela/M²)	
Degree	Avg. 0° Luminance
45	32555
55	25783
65	18560
75	12988
85	6349

Zonal Lumen Summary		
Zone	Lumens	% Fixture
0-30	222	33.2
0-40	358	53.5
0-60	582	86.9
0-90	670	100

\*CBCP

PHOTOMETRY

**RA5606927NFLWH**  
 Reflector Beam Angle = NFL Beam (Narrow Flood)  
 CCT = 2700K  
 Spacing Criteria = 0.36  
 Lumens per Watt = 62.5 Lm/W  
 Test No. P121911  
 Test Model: RA5606927NFLWH

Cone of Light Footcandles 0 deg Aiming Angle Horizontal Illuminance on Floor				
Distance to Illuminated Plane	Initial Nadir Footcandles	Beam (ft.)		CB
		L Length	W Width	
5.5'	90.3	1.8	1.8	
7'	55.8	2.4	2.4	
8'	42.7	2.8	2.8	
9'	33.7	3.2	3.2	
10'	27.3	3.6	3.6	

Cone of Light Footcandles 35 deg Aiming Angle Vertical Illuminance on Wall				
Distance to Illuminated Plane	Initial Nadir Footcandles	Beam (ft.)		CB
		L Length	W Width	
2'	157.4	1.7	1	2.9
3'	70	2.6	1.6	4.3
4'	39.4	3.5	2.2	5.7
5'	25.2	4.4	2.8	7.1
6'	17.5	5.3	3.4	8.6
8'	9.8	7	4.4	11.4
10'	6.3	8.8	5.6	14.3

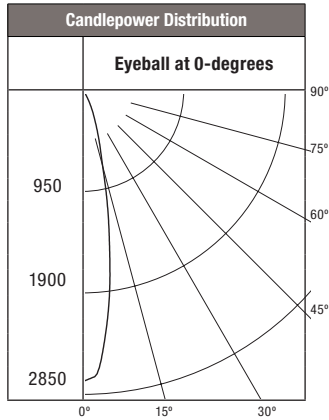

Candela Distribution	
Degrees Vertical	Candela
0*	2732
5	2371
15	740
25	239
35	69
45	27
55	16
65	9
75	3
85	0
90	0

Luminance (Average Candela/M²)	
Degree	Avg. 0° Luminance
45	4649
55	2981
65	1846
75	828
85	97

Zonal Lumen Summary		
Zone	Lumens	% Fixture
0-30	530	84.7
0-40	576	92.1
0-60	612	97.9
0-90	625	100

\*CBCP

**RA5606930NFLWH**  
 Reflector Beam Angle = NFL Beam (Narrow Flood)  
 CCT = 3000K  
 Spacing Criteria = 0.36  
 Lumens per Watt = 64 Lm/W  
 Test No. P121912  
 Test Model: RA5606930NFLWH

Cone of Light Footcandles 0 deg Aiming Angle Horizontal Illuminance on Floor				
Distance to Illuminated Plane	Initial Nadir Footcandles	Beam (ft.)		CB
		L Length	W Width	
5.5'	92.5	1.8	1.8	
7'	57.1	2.4	2.4	
8'	43.7	2.8	2.8	
9'	34.5	3.2	3.2	
10'	28	3.6	3.6	

Cone of Light Footcandles 35 deg Aiming Angle Vertical Illuminance on Wall				
Distance to Illuminated Plane	Initial Nadir Footcandles	Beam (ft.)		CB
		L Length	W Width	
2'	161.2	1.7	1	2.9
3'	71.6	2.6	1.6	4.3
4'	40.3	3.5	2.2	5.7
5'	25.8	4.4	2.8	7.1
6'	17.9	5.3	3.4	8.6
8'	10.1	7	4.4	11.4
10'	6.4	8.8	5.6	14.3

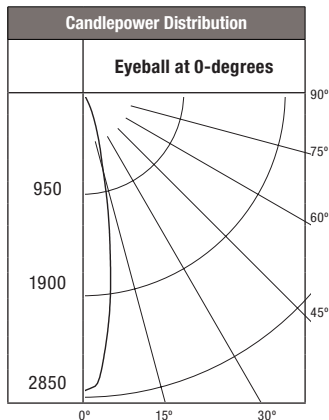

Candela Distribution	
Degrees Vertical	Candela
0*	2798
5	2428
15	758
25	245
35	70
45	28
55	17
65	9
75	3
85	0
90	0

Luminance (Average Candela/M²)	
Degree	Avg. 0° Luminance
45	4751
55	3055
65	1909
75	853
85	97

Zonal Lumen Summary		
Zone	Lumens	% Fixture
0-30	542	84.7
0-40	590	92.1
0-60	627	97.9
0-90	640	100

\*CBCP

Note: Specifications and Dimensions subject to change without notice.

Visit our web site at [www.cooperlighting.com](http://www.cooperlighting.com)

Customer First Center 1121 Highway 74 South Peachtree City, GA 30269 770.486.4800 FAX 770.486.4801  
 Cooper Lighting 5925 McLaughlin Rd. Mississauga, Ontario, Canada L5R 1B8 905.507.4000 FAX 905.568.7049