

# ELKAY<sup>®</sup>

## SPECIFICATIONS

### Gourmet e-dock™ Undermount Sink Model ELUH3118EK Series

#### NEW ELUH Installation Options

ELUH models have been redesigned to accommodate 1/2" reveal and no reveal installation options.

#### GENERAL

Highest quality sink formed of #18 (1.2mm) gauge, type 304 (18-8) nickel bearing stainless steel with e-dock. Undermount.

#### DESIGN FEATURES

Bowl Depths: 7-7/8" (200mm)  
Coved Corners: 1-3/4" (44mm) vertical and horizontal radius.  
Finish: Exposed surfaces are hand blended to a Lustrous Highlighted Satin finish.

Underside: Fully protected by Sound Guard<sup>®</sup> undercoating to reduce condensation and dampen sound.

e-dock sinks have been designed to allow stainless steel accessories to be magnetically positioned on any of the four sidewalls of the sink. Each e-dock sink is shipped with the stainless steel hook accessory (LKEKHOOK). Additional e-dock accessories are available.

#### Patent Pending

#### OTHER

Drain opening: 3-1/2" (89mm)

NOTE: All Elkay undermount sinks are designed to affix to the underside of any solid surface countertop.

Sink complies with ASME A112.19.3/ CSA B45.4



Sinks are listed by IAPMO<sup>®</sup> as meeting the applicable requirements of the Uniform Plumbing Code<sup>®</sup>, International Plumbing Code<sup>®</sup>, and National Plumbing Code of Canada.

#### OPTIONAL ACCESSORIES

Bottom Grid: LKWOBG1316SS

Cutting Boards: (All cutting boards for Reveal mount only) CB1613, CB1713, CBR1316, CBS1316

Drain: LK99

Mounting Clip: LKUCLIP8 (2 packages required)

Rinsing Baskets: LKWRB1316SS, LKWERBSS

Utensil Caddy for Rinsing Basket: LKWUCSS

#### e-dock ACCESSORIES\*

Model Number	Description	Overall			Material
		L	W	D	
LKEKSPONGE	Sponge Holder	3-1/2 (89mm)	1-1/4 (32mm)	3-1/8 (79mm)	Stainless Steel
LKEKLEDGE	Ledge	2-5/8 (67mm)	3-1/2 (89mm)	3-7/8 (98mm)	Stainless Steel
LKEKHOOK	Hook	1-3/4 (44mm)	1-1/8 (29mm)	2-7/16 (62mm)	Stainless Steel
LKEKUTENSIL	Utensil Holder	3 (76mm)	2-1/2 (51mm)	5-3/8 (137mm)	Stainless Steel
LKDEK35	Disposal Cover	2-11/16 (68mm)	2-11/16 (68mm)	1-1/4 (32mm)	Stainless Steel

\*Furnished with magnet (LKEKMAGNET)



LKEKSPONGE



LKEKLEDGE



LKEKHOOK

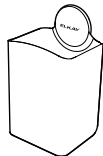

LKEKUTENSIL



LKDEK35

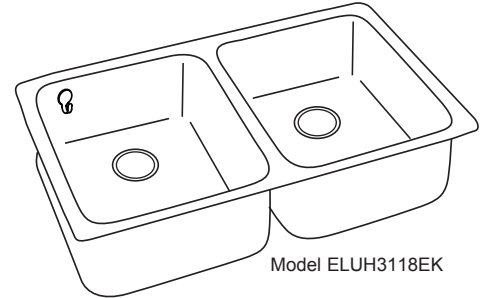

Model ELUH3118EK

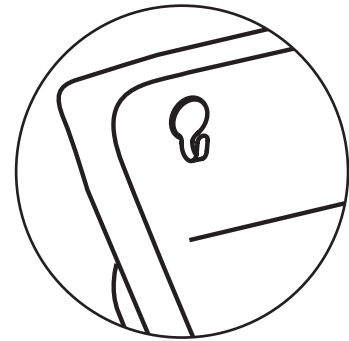

Included



All four sides of sink

**Warning:** This product contains magnets. Keep away from credit cards, computer hard drives, magnetic I.D. cards, and other magnetic media. Magnets may interfere with medical devices such as pacemakers. Consult your physician before use. Pinch hazard - magnets can jump out of your hands and snap together from a surprising distance before you realize what's happening.

In keeping with our policy of continuing product improvement, Elkay reserves the right to change product specifications without notice. Please visit [elkay.com](http://elkay.com) for the most current version of Elkay product specification sheets.

This specification describes an Elkay product with design, quality, and functional benefits to the user. When making a comparison of other producers' offerings, be certain these features are not overlooked.

# ELKAY<sup>®</sup> SPECIFICATIONS

## Gourmet e-dock™ Undermount Sink Model ELUH3118EK Series

### SINK DIMENSIONS\*

Model Number	Overall		Inside Left Bowl			Inside Right Bowl			Cutout in Countertop	Minimum Cabinet Size
	L	W	L	W	D	L	W	D		
ELUH3118EK	30-3/4 (781mm)	18-1/2 (470mm)	13-1/2 (343mm)	16 (406mm)	7-7/8 (200mm)	13-1/2 (343mm)	16 (406mm)	7-7/8 (200mm)	See Template**	36 (914mm)

\*Length is left to right. Width is front to back.

\*\*Template #1000001312 is packed with every sink.

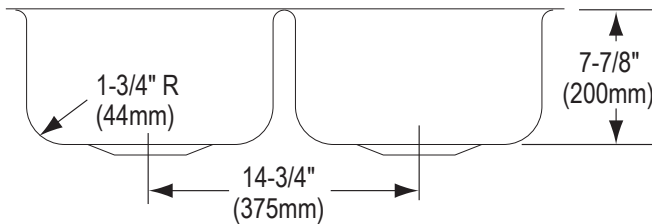
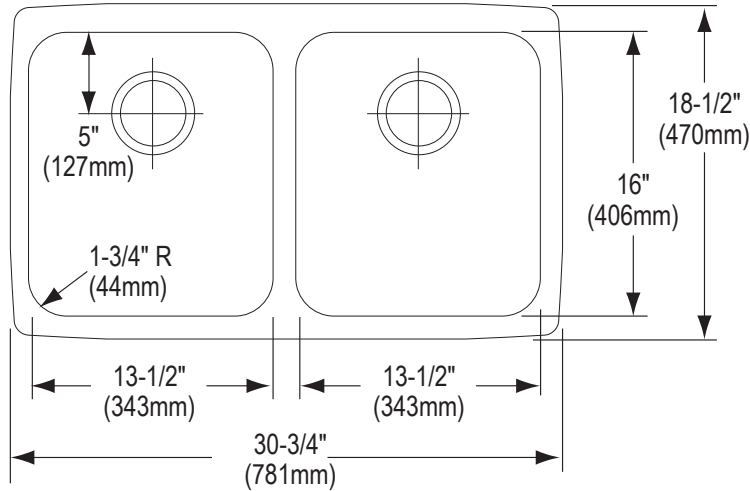

Model ELUH3118EK Illustrated

### Installation Profile

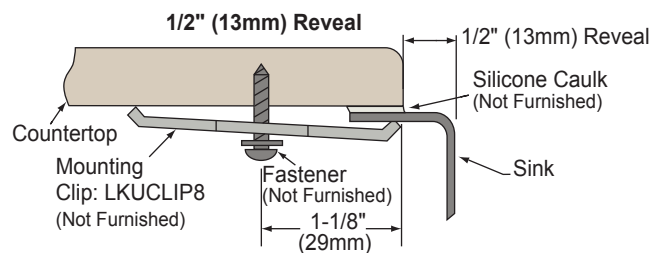
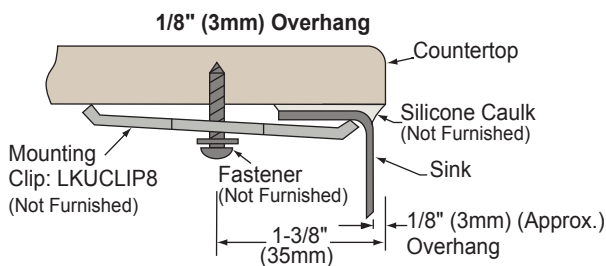

In keeping with our policy of continuing product improvement, Elkay reserves the right to change product specifications without notice. Please visit [elkay.com](http://elkay.com) for the most current version of Elkay product specification sheets.

This specification describes an Elkay product with design, quality, and functional benefits to the user. When making a comparison of other producers' offerings, be certain these features are not overlooked.