

R SERIES



RWHS14-SR

Shade Only.
Shown with optional
RSCK-SR Canopy Kit,
RS1-SR Stem and
RWG14-SR Wire Guard



RWHS14-SB

Shade Only.
Shown with optional
RSCK-SB Canopy Kit,
RS1-SB Stem and
RWG14-SB Wire Guard



RWHS14-SG

Shade Only.
Shown with optional
RGN15-SG Goose Neck

EASY TO ORDER:

1. Choose a Shade
2. Choose a Goose Neck for Wall Mount **OR** Choose a Stem & Canopy Kit for Ceiling Mount
3. Wire Guard Optional

GOOSE NECKS (Actual Photos Shown on Page 238)

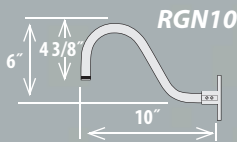

| | | |
|-----------|----------|-------|
| RGN10-ABR | ID: 3/4" | L:10" |
| RGN10-GA | ID: 3/4" | L:10" |
| RGN10-SB | ID: 3/4" | L:10" |
| RGN10-SG | ID: 3/4" | L:10" |
| RGN10-SR | ID: 3/4" | L:10" |
| RGN10-WH | ID: 3/4" | L:10" |

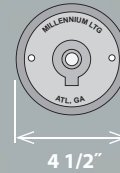

Back Plate included
with goose neck

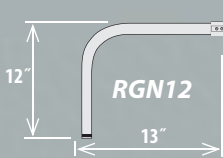

| | | |
|-----------|----------|-------|
| RGN12-ABR | ID: 3/4" | L:13" |
| RGN12-GA | ID: 3/4" | L:13" |
| RGN12-SB | ID: 3/4" | L:13" |
| RGN12-SG | ID: 3/4" | L:13" |
| RGN12-SR | ID: 3/4" | L:13" |
| RGN12-WH | ID: 3/4" | L:13" |

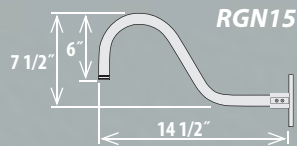

| | | |
|-----------|----------|-----------|
| RGN15-ABR | ID: 3/4" | L:14 1/2" |
| RGN15-GA | ID: 3/4" | L:14 1/2" |
| RGN15-SB | ID: 3/4" | L:14 1/2" |
| RGN15-SG | ID: 3/4" | L:14 1/2" |
| RGN15-SR | ID: 3/4" | L:14 1/2" |
| RGN15-WH | ID: 3/4" | L:14 1/2" |

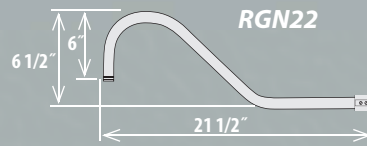

| | | |
|-----------|----------|-----------|
| RGN22-ABR | ID: 3/4" | L:21 1/2" |
| RGN22-GA | ID: 3/4" | L:21 1/2" |
| RGN22-SB | ID: 3/4" | L:21 1/2" |
| RGN22-SG | ID: 3/4" | L:21 1/2" |
| RGN22-SR | ID: 3/4" | L:21 1/2" |
| RGN22-WH | ID: 3/4" | L:21 1/2" |

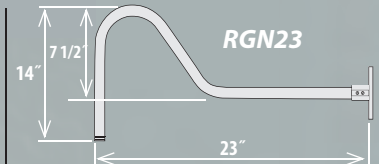

| | | |
|-----------|----------|-------|
| RGN23-ABR | ID: 3/4" | L:23" |
| RGN23-GA | ID: 3/4" | L:23" |
| RGN23-SB | ID: 3/4" | L:23" |
| RGN23-SG | ID: 3/4" | L:23" |
| RGN23-SR | ID: 3/4" | L:23" |
| RGN23-WH | ID: 3/4" | L:23" |

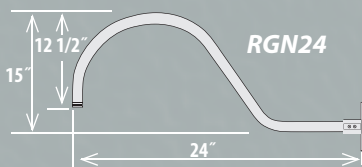

| | | |
|-----------|----------|-------|
| RGN24-ABR | ID: 3/4" | L:24" |
| RGN24-GA | ID: 3/4" | L:24" |
| RGN24-SB | ID: 3/4" | L:24" |
| RGN24-SG | ID: 3/4" | L:24" |
| RGN24-SR | ID: 3/4" | L:24" |
| RGN24-WH | ID: 3/4" | L:24" |

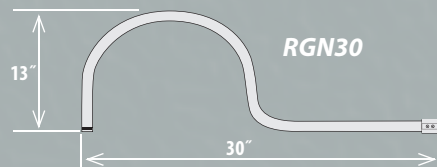

| | | |
|-----------|----------|-------|
| RGN30-ABR | ID: 3/4" | L:30" |
| RGN30-GA | ID: 3/4" | L:30" |
| RGN30-SB | ID: 3/4" | L:30" |
| RGN30-SG | ID: 3/4" | L:30" |
| RGN30-SR | ID: 3/4" | L:30" |
| RGN30-WH | ID: 3/4" | L:30" |

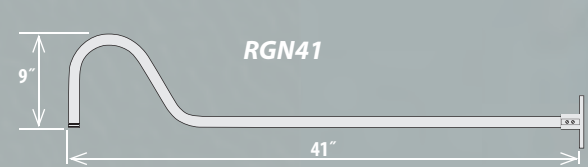

| | | |
|-----------|----------|-------|
| RGN41-ABR | ID: 3/4" | L:41" |
| RGN41-GA | ID: 3/4" | L:41" |
| RGN41-SB | ID: 3/4" | L:41" |
| RGN41-SG | ID: 3/4" | L:41" |
| RGN41-SR | ID: 3/4" | L:41" |
| RGN41-WH | ID: 3/4" | L:41" |

12" DEEP BOWL SHADES



RDBS12-SG

Shade Only.
Shown with optional
RSCK-SG Canopy Kit,
RS1-SG Stem and
RWG12-SG Wire Guard

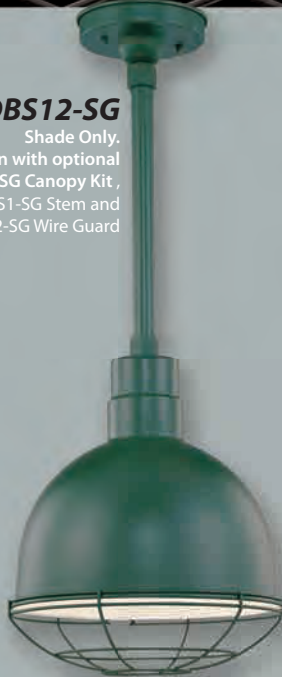

RDBS12-GA

Shade Only.
Shown with optional
RSCK-GA Canopy Kit and
RS1-GA Stem

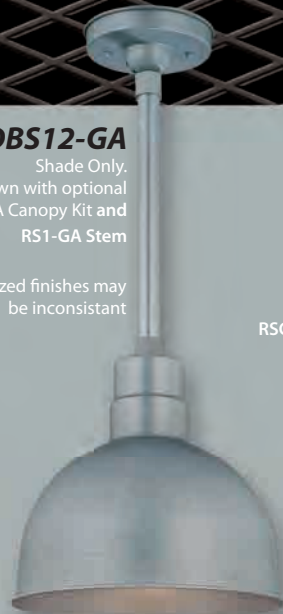

Galvanized finishes may be inconsistent

RDBS12-SB

Shade Only.
Shown with optional
RSCK-SB Canopy Kit and
RS1-SB Stem



Finishes:

- Architectural Bronze - ABR
- Galvanized - GA
- Satin Black - SB
- Satin Green - SG
- Satin Red - SR
- White - WH

DEEP BOWL SHADES

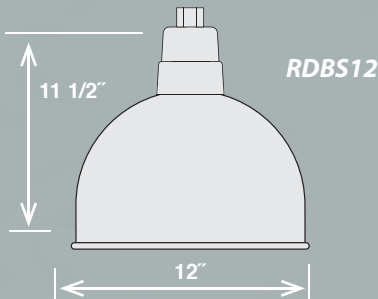

| | | | | |
|-------------------|--------|------------|------------|---------------|
| RDBS12-ABR | W: 12" | H: 11 1/2" | Wire: 100" | Med. 200W A21 |
| RDBS12-GA | W: 12" | H: 11 1/2" | Wire: 100" | Med. 200W A21 |
| RDBS12-SB | W: 12" | H: 11 1/2" | Wire: 100" | Med. 200W A21 |
| RDBS12-SG | W: 12" | H: 11 1/2" | Wire: 100" | Med. 200W A21 |
| RDBS12-SR | W: 12" | H: 11 1/2" | Wire: 100" | Med. 200W A21 |
| RDBS12-WH | W: 12" | H: 11 1/2" | Wire: 100" | Med. 200W A21 |

WIRE GUARDS

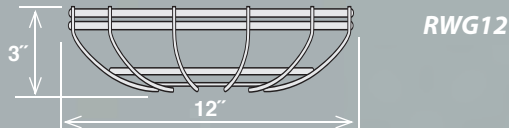

| | |
|------------------|--------|
| RWG12-ABR | W: 12" |
| RWG12-GA | W: 12" |
| RWG12-SB | W: 12" |
| RWG12-SG | W: 12" |
| RWG12-SR | W: 12" |
| RWG12-WH | W: 12" |

STEMS

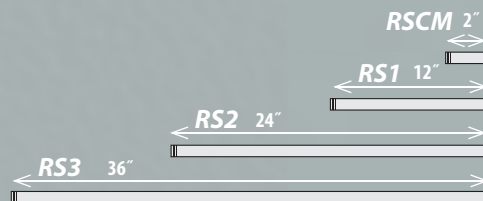

CANOPY KITS (for Ceiling Applications)

RSCK

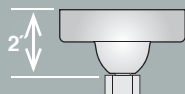
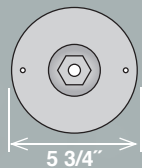

| | |
|-----------------|-----------|
| RSCK-ABR | W: 5 3/4" |
| RSCK-GA | W: 5 3/4" |
| RSCK-SB | W: 5 3/4" |
| RSCK-SG | W: 5 3/4" |
| RSCK-SR | W: 5 3/4" |
| RSCK-WH | W: 5 3/4" |

Canopy Kits will Swivel up to 25°

| | | | | | |
|-----------------|----------|-------|----------------|----------|--------|
| RSCM-ABR | ID: 3/4" | L: 2" | RS2-ABR | ID: 3/4" | L: 12" |
| RSCM-GA | ID: 3/4" | L: 2" | RS2-GA | ID: 3/4" | L: 12" |
| RSCM-SB | ID: 3/4" | L: 2" | RS2-SB | ID: 3/4" | L: 12" |
| RSCM-SG | ID: 3/4" | L: 2" | RS2-SG | ID: 3/4" | L: 12" |
| RSCM-SR | ID: 3/4" | L: 2" | RS2-SR | ID: 3/4" | L: 12" |
| RSCM-WH | ID: 3/4" | L: 2" | RS2-WH | ID: 3/4" | L: 12" |

| | | | | | |
|----------------|----------|--------|----------------|----------|--------|
| RS1-ABR | ID: 3/4" | L: 12" | RS3-ABR | ID: 3/4" | L: 12" |
| RS1-GA | ID: 3/4" | L: 12" | RS3-GA | ID: 3/4" | L: 12" |
| RS1-SB | ID: 3/4" | L: 12" | RS3-SB | ID: 3/4" | L: 12" |
| RS1-SG | ID: 3/4" | L: 12" | RS3-SG | ID: 3/4" | L: 12" |
| RS1-SR | ID: 3/4" | L: 12" | RS3-SR | ID: 3/4" | L: 12" |
| RS1-WH | ID: 3/4" | L: 12" | RS3-WH | ID: 3/4" | L: 12" |

R SERIES



RDBS12-SR
Shade Only.
Shown with optional
RSCK-SR Canopy Kit and
RS1-SR Stem



RDBS12-WH
Shade Only.
Shown with optional
RSCK-WH Canopy Kit and
RS1-WH Stem



RDBS12-ABR
Shade Only.
Shown with optional
RGN15-ABR Goose Neck

EASY TO ORDER:

1. Choose a Shade
2. Choose a Goose Neck for Wall Mount **OR** Choose a Stem & Canopy Kit for Ceiling Mount
3. Wire Guard Optional

GOOSE NECKS (Actual Photos Shown on Page 238)

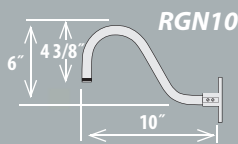

| | | |
|------------------|----------|-------|
| RGN10-ABR | ID: 3/4" | L:10" |
| RGN10-GA | ID: 3/4" | L:10" |
| RGN10-SB | ID: 3/4" | L:10" |
| RGN10-SG | ID: 3/4" | L:10" |
| RGN10-SR | ID: 3/4" | L:10" |
| RGN10-WH | ID: 3/4" | L:10" |

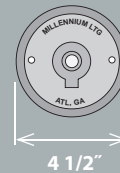

Back Plate included with goose neck

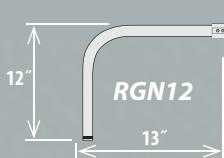

| | | |
|------------------|----------|-------|
| RGN12-ABR | ID: 3/4" | L:13" |
| RGN12-GA | ID: 3/4" | L:13" |
| RGN12-SB | ID: 3/4" | L:13" |
| RGN12-SG | ID: 3/4" | L:13" |
| RGN12-SR | ID: 3/4" | L:13" |
| RGN12-WH | ID: 3/4" | L:13" |

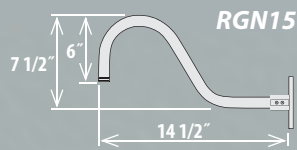

| | | |
|------------------|----------|-----------|
| RGN15-ABR | ID: 3/4" | L:14 1/2" |
| RGN15-GA | ID: 3/4" | L:14 1/2" |
| RGN15-SB | ID: 3/4" | L:14 1/2" |
| RGN15-SG | ID: 3/4" | L:14 1/2" |
| RGN15-SR | ID: 3/4" | L:14 1/2" |
| RGN15-WH | ID: 3/4" | L:14 1/2" |

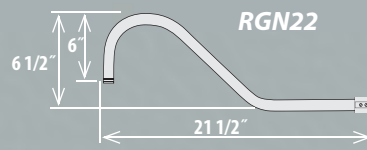

| | | |
|------------------|----------|-----------|
| RGN22-ABR | ID: 3/4" | L:21 1/2" |
| RGN22-GA | ID: 3/4" | L:21 1/2" |
| RGN22-SB | ID: 3/4" | L:21 1/2" |
| RGN22-SG | ID: 3/4" | L:21 1/2" |
| RGN22-SR | ID: 3/4" | L:21 1/2" |
| RGN22-WH | ID: 3/4" | L:21 1/2" |

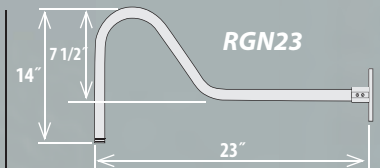

| | | |
|------------------|----------|-------|
| RGN23-ABR | ID: 3/4" | L:23" |
| RGN23-GA | ID: 3/4" | L:23" |
| RGN23-SB | ID: 3/4" | L:23" |
| RGN23-SG | ID: 3/4" | L:23" |
| RGN23-SR | ID: 3/4" | L:23" |
| RGN23-WH | ID: 3/4" | L:23" |

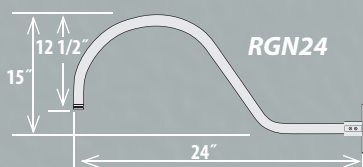

| | | |
|------------------|----------|-------|
| RGN24-ABR | ID: 3/4" | L:24" |
| RGN24-GA | ID: 3/4" | L:24" |
| RGN24-SB | ID: 3/4" | L:24" |
| RGN24-SG | ID: 3/4" | L:24" |
| RGN24-SR | ID: 3/4" | L:24" |
| RGN24-WH | ID: 3/4" | L:24" |

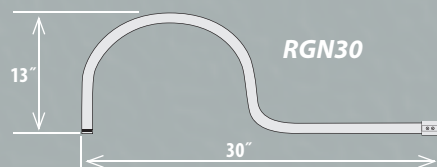

| | | |
|------------------|----------|-------|
| RGN30-ABR | ID: 3/4" | L:30" |
| RGN30-GA | ID: 3/4" | L:30" |
| RGN30-SB | ID: 3/4" | L:30" |
| RGN30-SG | ID: 3/4" | L:30" |
| RGN30-SR | ID: 3/4" | L:30" |
| RGN30-WH | ID: 3/4" | L:30" |

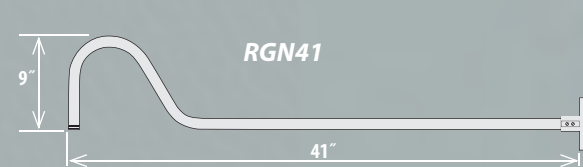

| | | |
|------------------|----------|-------|
| RGN41-ABR | ID: 3/4" | L:41" |
| RGN41-GA | ID: 3/4" | L:41" |
| RGN41-SB | ID: 3/4" | L:41" |
| RGN41-SG | ID: 3/4" | L:41" |
| RGN41-SR | ID: 3/4" | L:41" |
| RGN41-WH | ID: 3/4" | L:41" |

10" DEEP BOWL SHADES



RDBS10-ABR

Shade Only.
Shown with optional
RSCK-ABR Canopy Kit and
RS1-ABR Stem



RDBS10-WH

Shade Only.
Shown with optional
RSCK-WH Canopy Kit,
RS1-WH Stem and
RWG10-WH Wire Guard



RDBS10-SG

Shade Only.
Shown with optional
RSCK-SG Canopy Kit and
RS1-SG Stem



Finishes:

- Architectural Bronze - ABR
- Galvanized - GA
- Satin Black - SB
- Satin Green - SG
- Satin Red - SR
- White - WH

DEEP BOWL SHADES

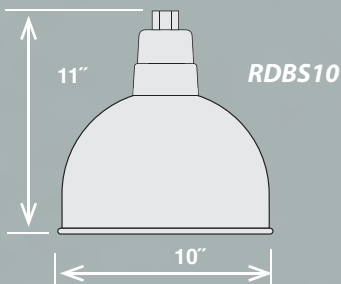

| | | | | |
|------------|--------|--------|------------|---------------|
| RDBS10-ABR | W: 10" | H: 11" | Wire: 100" | Med. 200W A21 |
| RDBS10-GA | W: 10" | H: 11" | Wire: 100" | Med. 200W A21 |
| RDBS10-SB | W: 10" | H: 11" | Wire: 100" | Med. 200W A21 |
| RDBS10-SG | W: 10" | H: 11" | Wire: 100" | Med. 200W A21 |
| RDBS10-SR | W: 10" | H: 11" | Wire: 100" | Med. 200W A21 |
| RDBS10-WH | W: 10" | H: 11" | Wire: 100" | Med. 200W A21 |

WIRE GUARDS

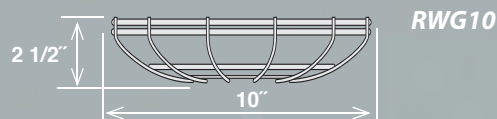

| | |
|-----------|--------|
| RWG10-ABR | W: 10" |
| RWG10-GA | W: 10" |
| RWG10-SB | W: 10" |
| RWG10-SG | W: 10" |
| RWG10-SR | W: 10" |
| RWG10-WH | W: 10" |

STEMS

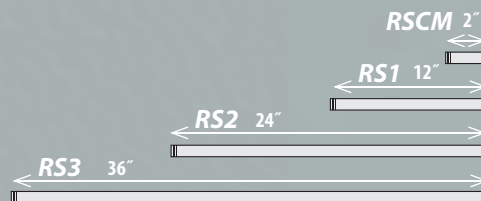

CANOPY KITS (for Ceiling Applications)

RSCK

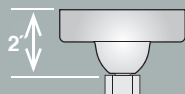
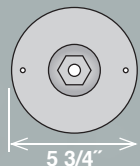

| | |
|----------|-----------|
| RSCK-ABR | W: 5 3/4" |
| RSCK-GA | W: 5 3/4" |
| RSCK-SB | W: 5 3/4" |
| RSCK-SG | W: 5 3/4" |
| RSCK-SR | W: 5 3/4" |
| RSCK-WH | W: 5 3/4" |

Canopy Kits will Swivel up to 25°

| | | | | | |
|----------|----------|--------|---------|----------|--------|
| RSCM-ABR | ID: 3/4" | L: 2" | RS2-ABR | ID: 3/4" | L: 12" |
| RSCM-GA | ID: 3/4" | L: 2" | RS2-GA | ID: 3/4" | L: 12" |
| RSCM-SB | ID: 3/4" | L: 2" | RS2-SB | ID: 3/4" | L: 12" |
| RSCM-SG | ID: 3/4" | L: 2" | RS2-SG | ID: 3/4" | L: 12" |
| RSCM-SR | ID: 3/4" | L: 2" | RS2-SR | ID: 3/4" | L: 12" |
| RSCM-WH | ID: 3/4" | L: 2" | RS2-WH | ID: 3/4" | L: 12" |
| RS1-ABR | ID: 3/4" | L: 12" | RS3-ABR | ID: 3/4" | L: 12" |
| RS1-GA | ID: 3/4" | L: 12" | RS3-GA | ID: 3/4" | L: 12" |
| RS1-SB | ID: 3/4" | L: 12" | RS3-SB | ID: 3/4" | L: 12" |
| RS1-SG | ID: 3/4" | L: 12" | RS3-SG | ID: 3/4" | L: 12" |
| RS1-SR | ID: 3/4" | L: 12" | RS3-SR | ID: 3/4" | L: 12" |
| RS1-WH | ID: 3/4" | L: 12" | RS3-WH | ID: 3/4" | L: 12" |

R SERIES



RDBS10-GA

Shade Only.
Shown with optional
RSCK-GA Canopy Kit,
RS1-GA Stem and
RWG10-GA Wire Guard

Galvanized finishes may
be inconsistent



RDBS10-SB

Shade Only.
Shown with optional
RSCK-SB Canopy Kit and
RS1-SB Stem



RDBS10-SR

Shade Only.
Shown with optional
RGN15-SR Goose Neck

EASY TO ORDER:

1. Choose a Shade
2. Choose a Goose Neck
for Wall Mount **OR**
Choose a Stem & Canopy Kit
for Ceiling Mount
3. Wire Guard Optional

GOOSE NECKS (Actual Photos Shown on Page 238)

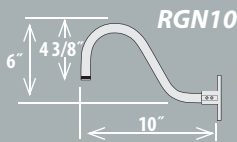

| | | |
|-----------|----------|-------|
| RGN10-ABR | ID: 3/4" | L:10" |
| RGN10-GA | ID: 3/4" | L:10" |
| RGN10-SB | ID: 3/4" | L:10" |
| RGN10-SG | ID: 3/4" | L:10" |
| RGN10-SR | ID: 3/4" | L:10" |
| RGN10-WH | ID: 3/4" | L:10" |

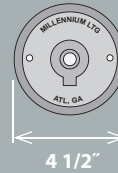

Back Plate included
with goose neck

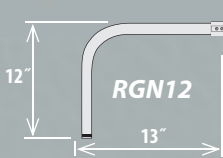

| | | |
|-----------|----------|-------|
| RGN12-ABR | ID: 3/4" | L:13" |
| RGN12-GA | ID: 3/4" | L:13" |
| RGN12-SB | ID: 3/4" | L:13" |
| RGN12-SG | ID: 3/4" | L:13" |
| RGN12-SR | ID: 3/4" | L:13" |
| RGN12-WH | ID: 3/4" | L:13" |

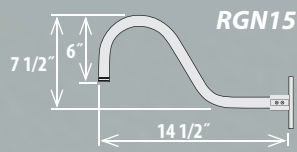

| | | |
|-----------|----------|-----------|
| RGN15-ABR | ID: 3/4" | L:14 1/2" |
| RGN15-GA | ID: 3/4" | L:14 1/2" |
| RGN15-SB | ID: 3/4" | L:14 1/2" |
| RGN15-SG | ID: 3/4" | L:14 1/2" |
| RGN15-SR | ID: 3/4" | L:14 1/2" |
| RGN15-WH | ID: 3/4" | L:14 1/2" |

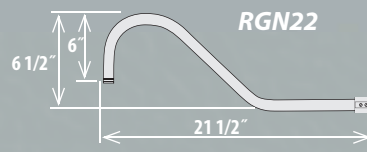

| | | |
|-----------|----------|-----------|
| RGN22-ABR | ID: 3/4" | L:21 1/2" |
| RGN22-GA | ID: 3/4" | L:21 1/2" |
| RGN22-SB | ID: 3/4" | L:21 1/2" |
| RGN22-SG | ID: 3/4" | L:21 1/2" |
| RGN22-SR | ID: 3/4" | L:21 1/2" |
| RGN22-WH | ID: 3/4" | L:21 1/2" |

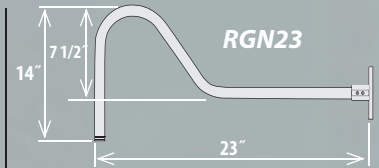

| | | |
|-----------|----------|-------|
| RGN23-ABR | ID: 3/4" | L:23" |
| RGN23-GA | ID: 3/4" | L:23" |
| RGN23-SB | ID: 3/4" | L:23" |
| RGN23-SG | ID: 3/4" | L:23" |
| RGN23-SR | ID: 3/4" | L:23" |
| RGN23-WH | ID: 3/4" | L:23" |

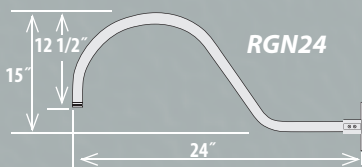

| | | |
|-----------|----------|-------|
| RGN24-ABR | ID: 3/4" | L:24" |
| RGN24-GA | ID: 3/4" | L:24" |
| RGN24-SB | ID: 3/4" | L:24" |
| RGN24-SG | ID: 3/4" | L:24" |
| RGN24-SR | ID: 3/4" | L:24" |
| RGN24-WH | ID: 3/4" | L:24" |

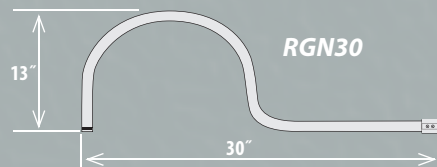

| | | |
|-----------|----------|-------|
| RGN30-ABR | ID: 3/4" | L:30" |
| RGN30-GA | ID: 3/4" | L:30" |
| RGN30-SB | ID: 3/4" | L:30" |
| RGN30-SG | ID: 3/4" | L:30" |
| RGN30-SR | ID: 3/4" | L:30" |
| RGN30-WH | ID: 3/4" | L:30" |

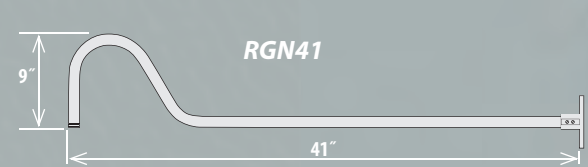

| | | |
|-----------|----------|-------|
| RGN41-ABR | ID: 3/4" | L:41" |
| RGN41-GA | ID: 3/4" | L:41" |
| RGN41-SB | ID: 3/4" | L:41" |
| RGN41-SG | ID: 3/4" | L:41" |
| RGN41-SR | ID: 3/4" | L:41" |
| RGN41-WH | ID: 3/4" | L:41" |

12" ANGLE SHADES



RAS12-WH
Shade Only.
Shown with optional
RGN15-WH Goose Neck



RAS12-SG
Shade Only.
Shown with optional
RGN15-SG Goose Neck



RAS12-SR
Shade Only.
Shown with optional
RGN15-SR Goose Neck

Finishes:

- Architectural Bronze - ABR
- Galvanized - GA
- Satin Black - SB
- Satin Green - SG
- Satin Red - SR
- White - WH

ANGLE SHADES

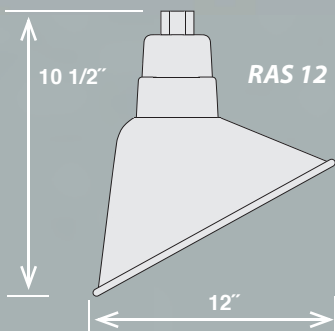

| | | | | |
|-----------|--------|------------|------------|---------------|
| RAS12-ABR | W: 12" | H: 10 1/2" | Wire: 100" | Med. 200W A21 |
| RAS12-GA | W: 12" | H: 10 1/2" | Wire: 100" | Med. 200W A21 |
| RAS12-SB | W: 12" | H: 10 1/2" | Wire: 100" | Med. 200W A21 |
| RAS12-SG | W: 12" | H: 10 1/2" | Wire: 100" | Med. 200W A21 |
| RAS12-SR | W: 12" | H: 10 1/2" | Wire: 100" | Med. 200W A21 |
| RAS12-WH | W: 12" | H: 10 1/2" | Wire: 100" | Med. 200W A21 |

WIRE GUARDS

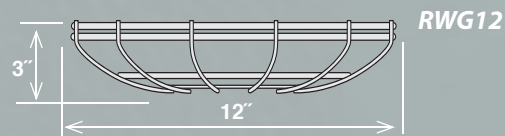

| | |
|-----------|--------|
| RWG12-ABR | W: 12" |
| RWG12-GA | W: 12" |
| RWG12-SB | W: 12" |
| RWG12-SG | W: 12" |
| RWG12-SR | W: 12" |
| RWG12-WH | W: 12" |

R SERIES



RAS12-SB
Shade Only.
Shown with optional
RGN15-SB Goose Neck
and RWG12-SB Wire Guard



RAS12-ABR
Shade Only.
Shown with optional
RGN15-ABR Goose Neck
and RWG12-ABR Wire Guard



RAS12-GA
Shade Only.
Shown with optional
RGN15-GA Goose Neck
and RWG12-GA Wire Guard

Galvanized finishes may be inconsistent

EASY TO ORDER:

1. Choose a Shade
2. Choose a Goose Neck for Wall Mount **OR** Choose a Stem & Canopy Kit for Ceiling Mount
3. Wire Guard Optional

GOOSE NECKS (Actual Photos Shown on Page 238)

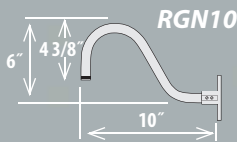

| | | |
|------------------|----------|-------|
| RGN10-ABR | ID: 3/4" | L:10" |
| RGN10-GA | ID: 3/4" | L:10" |
| RGN10-SB | ID: 3/4" | L:10" |
| RGN10-SG | ID: 3/4" | L:10" |
| RGN10-SR | ID: 3/4" | L:10" |
| RGN10-WH | ID: 3/4" | L:10" |

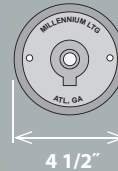

Back Plate included with goose neck

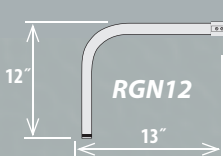

| | | |
|------------------|----------|-------|
| RGN12-ABR | ID: 3/4" | L:13" |
| RGN12-GA | ID: 3/4" | L:13" |
| RGN12-SB | ID: 3/4" | L:13" |
| RGN12-SG | ID: 3/4" | L:13" |
| RGN12-SR | ID: 3/4" | L:13" |
| RGN12-WH | ID: 3/4" | L:13" |

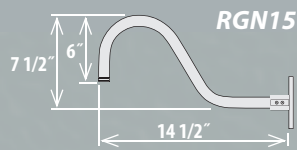

| | | |
|------------------|----------|-----------|
| RGN15-ABR | ID: 3/4" | L:14 1/2" |
| RGN15-GA | ID: 3/4" | L:14 1/2" |
| RGN15-SB | ID: 3/4" | L:14 1/2" |
| RGN15-SG | ID: 3/4" | L:14 1/2" |
| RGN15-SR | ID: 3/4" | L:14 1/2" |
| RGN15-WH | ID: 3/4" | L:14 1/2" |

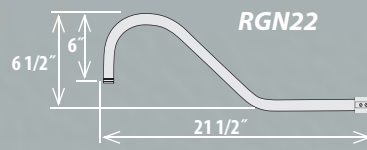

| | | |
|------------------|----------|-----------|
| RGN22-ABR | ID: 3/4" | L:21 1/2" |
| RGN22-GA | ID: 3/4" | L:21 1/2" |
| RGN22-SB | ID: 3/4" | L:21 1/2" |
| RGN22-SG | ID: 3/4" | L:21 1/2" |
| RGN22-SR | ID: 3/4" | L:21 1/2" |
| RGN22-WH | ID: 3/4" | L:21 1/2" |

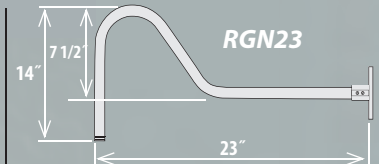

| | | |
|------------------|----------|-------|
| RGN23-ABR | ID: 3/4" | L:23" |
| RGN23-GA | ID: 3/4" | L:23" |
| RGN23-SB | ID: 3/4" | L:23" |
| RGN23-SG | ID: 3/4" | L:23" |
| RGN23-SR | ID: 3/4" | L:23" |
| RGN23-WH | ID: 3/4" | L:23" |

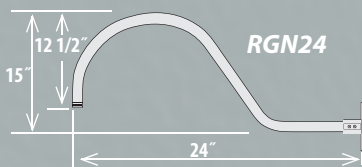

| | | |
|------------------|----------|-------|
| RGN24-ABR | ID: 3/4" | L:24" |
| RGN24-GA | ID: 3/4" | L:24" |
| RGN24-SB | ID: 3/4" | L:24" |
| RGN24-SG | ID: 3/4" | L:24" |
| RGN24-SR | ID: 3/4" | L:24" |
| RGN24-WH | ID: 3/4" | L:24" |

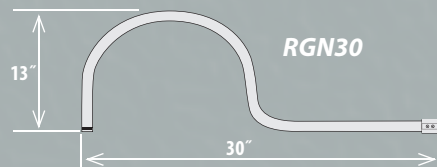

| | | |
|------------------|----------|-------|
| RGN30-ABR | ID: 3/4" | L:30" |
| RGN30-GA | ID: 3/4" | L:30" |
| RGN30-SB | ID: 3/4" | L:30" |
| RGN30-SG | ID: 3/4" | L:30" |
| RGN30-SR | ID: 3/4" | L:30" |
| RGN30-WH | ID: 3/4" | L:30" |

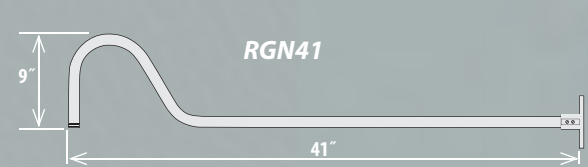

| | | |
|------------------|----------|-------|
| RGN41-ABR | ID: 3/4" | L:41" |
| RGN41-GA | ID: 3/4" | L:41" |
| RGN41-SB | ID: 3/4" | L:41" |
| RGN41-SG | ID: 3/4" | L:41" |
| RGN41-SR | ID: 3/4" | L:41" |
| RGN41-WH | ID: 3/4" | L:41" |

10" ANGLE SHADES



RAS10-ABR
Shade Only.
Shown with optional
RGN15-ABR Goose Neck

Finishes:

- Architectural Bronze - ABR
- Galvanized - GA
- Satin Black - SB
- Satin Green - SG
- Satin Red - SR
- White - WH



RAS10-WH
Shade Only.
Shown with optional
RGN15-WH Goose Neck

RAS10-SG

Shade Only.
Shown with optional
RGN15-SG Goose Neck
and RWG10-SG Wire Guard



ANGLE SHADES

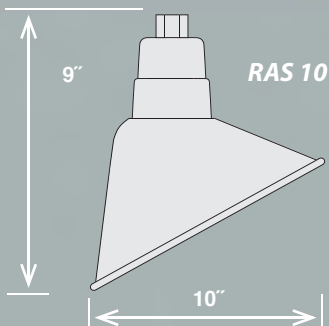

| | | | | |
|-----------|--------|-------|------------|---------------|
| RAS10-ABR | W: 10" | H: 9" | Wire: 100" | Med. 200W A21 |
| RAS10-GA | W: 10" | H: 9" | Wire: 100" | Med. 200W A21 |
| RAS10-SB | W: 10" | H: 9" | Wire: 100" | Med. 200W A21 |
| RAS10-SG | W: 10" | H: 9" | Wire: 100" | Med. 200W A21 |
| RAS10-SR | W: 10" | H: 9" | Wire: 100" | Med. 200W A21 |
| RAS10-WH | W: 10" | H: 9" | Wire: 100" | Med. 200W A21 |

WIRE GUARDS

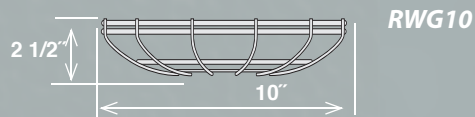

| | |
|-----------|--------|
| RWG10-ABR | W: 10" |
| RWG10-GA | W: 10" |
| RWG10-SB | W: 10" |
| RWG10-SG | W: 10" |
| RWG10-SR | W: 10" |
| RWG10-WH | W: 10" |

R SERIES



RAS10-SR
Shade Only.
Shown with optional
RGN15-SR Goose Neck



RAS10-SB
Shade Only.
Shown with optional
RGN15-SB Goose Neck



RAS10-GA
Shade Only.
Shown with optional
RGN15-GA Goose Neck

Galvanized finishes may be inconsistent

EASY TO ORDER:

1. Choose a Shade
2. Choose a Goose Neck for Wall Mount **OR** Choose a Stem & Canopy Kit for Ceiling Mount
3. Wire Guard Optional

GOOSE NECKS (Actual Photos Shown on Page 238)

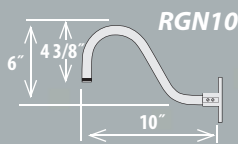

| | | |
|------------------|----------|-------|
| RGN10-ABR | ID: 3/4" | L:10" |
| RGN10-GA | ID: 3/4" | L:10" |
| RGN10-SB | ID: 3/4" | L:10" |
| RGN10-SG | ID: 3/4" | L:10" |
| RGN10-SR | ID: 3/4" | L:10" |
| RGN10-WH | ID: 3/4" | L:10" |

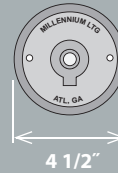

Back Plate included with goose neck

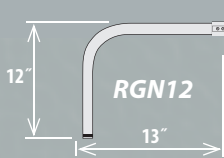

| | | |
|------------------|----------|-------|
| RGN12-ABR | ID: 3/4" | L:13" |
| RGN12-GA | ID: 3/4" | L:13" |
| RGN12-SB | ID: 3/4" | L:13" |
| RGN12-SG | ID: 3/4" | L:13" |
| RGN12-SR | ID: 3/4" | L:13" |
| RGN12-WH | ID: 3/4" | L:13" |

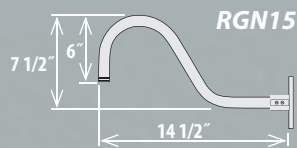

| | | |
|------------------|----------|-----------|
| RGN15-ABR | ID: 3/4" | L:14 1/2" |
| RGN15-GA | ID: 3/4" | L:14 1/2" |
| RGN15-SB | ID: 3/4" | L:14 1/2" |
| RGN15-SG | ID: 3/4" | L:14 1/2" |
| RGN15-SR | ID: 3/4" | L:14 1/2" |
| RGN15-WH | ID: 3/4" | L:14 1/2" |

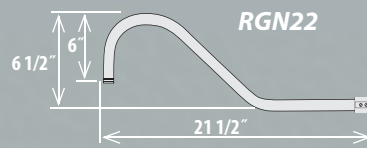

| | | |
|------------------|----------|-----------|
| RGN22-ABR | ID: 3/4" | L:21 1/2" |
| RGN22-GA | ID: 3/4" | L:21 1/2" |
| RGN22-SB | ID: 3/4" | L:21 1/2" |
| RGN22-SG | ID: 3/4" | L:21 1/2" |
| RGN22-SR | ID: 3/4" | L:21 1/2" |
| RGN22-WH | ID: 3/4" | L:21 1/2" |

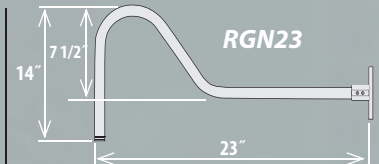

| | | |
|------------------|----------|-------|
| RGN23-ABR | ID: 3/4" | L:23" |
| RGN23-GA | ID: 3/4" | L:23" |
| RGN23-SB | ID: 3/4" | L:23" |
| RGN23-SG | ID: 3/4" | L:23" |
| RGN23-SR | ID: 3/4" | L:23" |
| RGN23-WH | ID: 3/4" | L:23" |

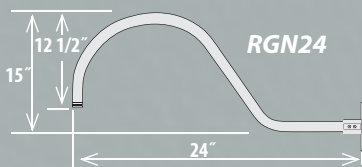

| | | |
|------------------|----------|-------|
| RGN24-ABR | ID: 3/4" | L:24" |
| RGN24-GA | ID: 3/4" | L:24" |
| RGN24-SB | ID: 3/4" | L:24" |
| RGN24-SG | ID: 3/4" | L:24" |
| RGN24-SR | ID: 3/4" | L:24" |
| RGN24-WH | ID: 3/4" | L:24" |

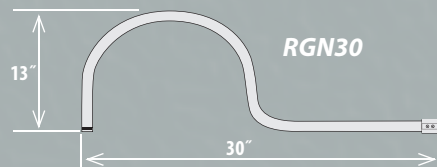

| | | |
|------------------|----------|-------|
| RGN30-ABR | ID: 3/4" | L:30" |
| RGN30-GA | ID: 3/4" | L:30" |
| RGN30-SB | ID: 3/4" | L:30" |
| RGN30-SG | ID: 3/4" | L:30" |
| RGN30-SR | ID: 3/4" | L:30" |
| RGN30-WH | ID: 3/4" | L:30" |

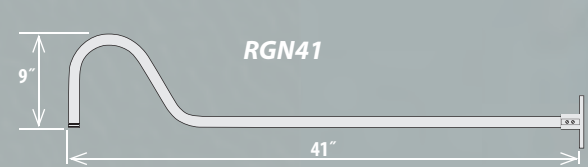

| | | |
|------------------|----------|-------|
| RGN41-ABR | ID: 3/4" | L:41" |
| RGN41-GA | ID: 3/4" | L:41" |
| RGN41-SB | ID: 3/4" | L:41" |
| RGN41-SG | ID: 3/4" | L:41" |
| RGN41-SR | ID: 3/4" | L:41" |
| RGN41-WH | ID: 3/4" | L:41" |

12" EMBLEM SHADES



RES12-GA

Shade Only.
Shown with optional
RGN15-GA Goose Neck



Galvanized finishes may
be inconsistent

Finishes:

- Architectural Bronze - ABR
- Galvanized - GA
- Satin Black - SB
- Satin Green - SG
- Satin Red - SR
- White - WH

RES12-ABR

Shade Only.
Shown with optional
RGN15-ABR Goose Neck



RES12-SR

Shade Only.
Shown with optional
RGN15-SR Goose Neck



EMBLEM SHADES

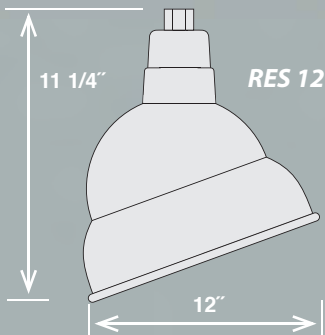

| | | | | |
|-----------|--------|------------|------------|---------------|
| RES12-ABR | W: 12" | H: 11 1/4" | Wire: 100" | Med. 200W A21 |
| RES12-GA | W: 12" | H: 11 1/4" | Wire: 100" | Med. 200W A21 |
| RES12-SB | W: 12" | H: 11 1/4" | Wire: 100" | Med. 200W A21 |
| RES12-SG | W: 12" | H: 11 1/4" | Wire: 100" | Med. 200W A21 |
| RES12-SR | W: 12" | H: 11 1/4" | Wire: 100" | Med. 200W A21 |
| RES12-WH | W: 12" | H: 11 1/4" | Wire: 100" | Med. 200W A21 |

WIRE GUARDS

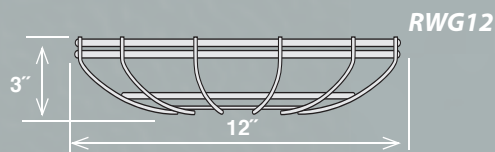

| | |
|-----------|--------|
| RWG12-ABR | W: 12" |
| RWG12-GA | W: 12" |
| RWG12-SB | W: 12" |
| RWG12-SG | W: 12" |
| RWG12-SR | W: 12" |
| RWG12-WH | W: 12" |

R SERIES



RES12-WH
Shade Only.
Shown with optional
RGN15-WH Goose Neck
and RWG12-WH Wire Guard

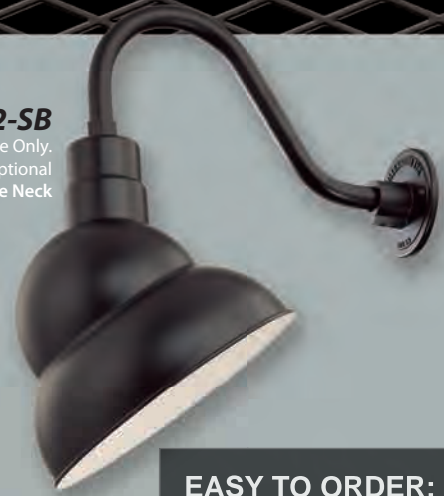

RES12-SB
Shade Only.
Shown with optional
RGN15-SB Goose Neck



RES12-SG
Shade Only.
Shown with optional
RGN15-SG Goose Neck

EASY TO ORDER:

1. Choose a Shade
2. Choose a Goose Neck for Wall Mount **OR** Choose a Stem & Canopy Kit for Ceiling Mount
3. Wire Guard Optional

GOOSE NECKS (Actual Photos Shown on Page 238)

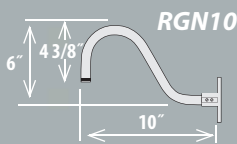

| | | |
|------------------|----------|-------|
| RGN10-ABR | ID: 3/4" | L:10" |
| RGN10-GA | ID: 3/4" | L:10" |
| RGN10-SB | ID: 3/4" | L:10" |
| RGN10-SG | ID: 3/4" | L:10" |
| RGN10-SR | ID: 3/4" | L:10" |
| RGN10-WH | ID: 3/4" | L:10" |

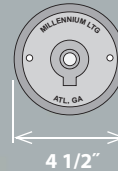

Back Plate included with goose neck

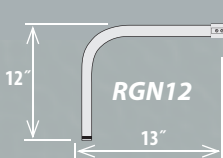

| | | |
|------------------|----------|-------|
| RGN12-ABR | ID: 3/4" | L:13" |
| RGN12-GA | ID: 3/4" | L:13" |
| RGN12-SB | ID: 3/4" | L:13" |
| RGN12-SG | ID: 3/4" | L:13" |
| RGN12-SR | ID: 3/4" | L:13" |
| RGN12-WH | ID: 3/4" | L:13" |

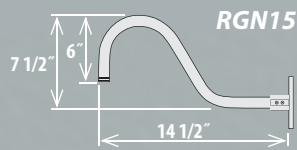

| | | |
|------------------|----------|-----------|
| RGN15-ABR | ID: 3/4" | L:14 1/2" |
| RGN15-GA | ID: 3/4" | L:14 1/2" |
| RGN15-SB | ID: 3/4" | L:14 1/2" |
| RGN15-SG | ID: 3/4" | L:14 1/2" |
| RGN15-SR | ID: 3/4" | L:14 1/2" |
| RGN15-WH | ID: 3/4" | L:14 1/2" |

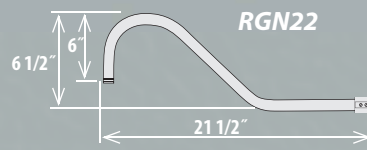

| | | |
|------------------|----------|-----------|
| RGN22-ABR | ID: 3/4" | L:21 1/2" |
| RGN22-GA | ID: 3/4" | L:21 1/2" |
| RGN22-SB | ID: 3/4" | L:21 1/2" |
| RGN22-SG | ID: 3/4" | L:21 1/2" |
| RGN22-SR | ID: 3/4" | L:21 1/2" |
| RGN22-WH | ID: 3/4" | L:21 1/2" |

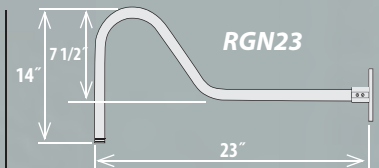

| | | |
|------------------|----------|-------|
| RGN23-ABR | ID: 3/4" | L:23" |
| RGN23-GA | ID: 3/4" | L:23" |
| RGN23-SB | ID: 3/4" | L:23" |
| RGN23-SG | ID: 3/4" | L:23" |
| RGN23-SR | ID: 3/4" | L:23" |
| RGN23-WH | ID: 3/4" | L:23" |

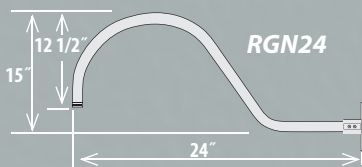

| | | |
|------------------|----------|-------|
| RGN24-ABR | ID: 3/4" | L:24" |
| RGN24-GA | ID: 3/4" | L:24" |
| RGN24-SB | ID: 3/4" | L:24" |
| RGN24-SG | ID: 3/4" | L:24" |
| RGN24-SR | ID: 3/4" | L:24" |
| RGN24-WH | ID: 3/4" | L:24" |

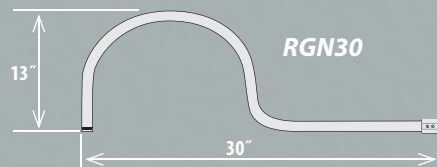

| | | |
|------------------|----------|-------|
| RGN30-ABR | ID: 3/4" | L:30" |
| RGN30-GA | ID: 3/4" | L:30" |
| RGN30-SB | ID: 3/4" | L:30" |
| RGN30-SG | ID: 3/4" | L:30" |
| RGN30-SR | ID: 3/4" | L:30" |
| RGN30-WH | ID: 3/4" | L:30" |

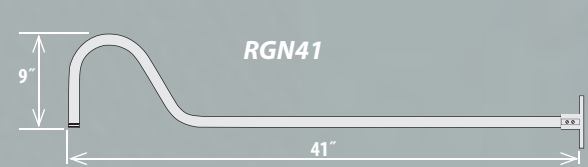

| | | |
|------------------|----------|-------|
| RGN41-ABR | ID: 3/4" | L:41" |
| RGN41-GA | ID: 3/4" | L:41" |
| RGN41-SB | ID: 3/4" | L:41" |
| RGN41-SG | ID: 3/4" | L:41" |
| RGN41-SR | ID: 3/4" | L:41" |
| RGN41-WH | ID: 3/4" | L:41" |

10" EMBLEM SHADES



RES10-WH
Shade Only.
Shown with optional
RGN15-WH Goose Neck

Finishes:
Architectural Bronze - ABR
Galvanized - GA
Satin Black - SB
Satin Green - SG
Satin Red - SR
White - WH



RES10-SB
Shade Only.
Shown with optional
RGN15-SB Goose Neck
and RWG10-SB Wire Guard



RES10-SG
Shade Only.
Shown with optional
RGN15-SG Goose Neck

EMBLEM SHADES

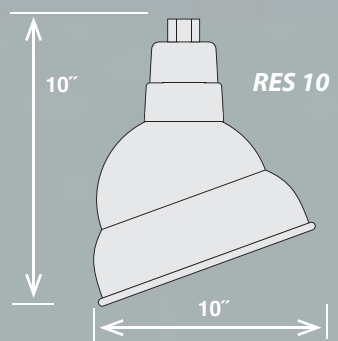

| | | | | |
|-----------|--------|--------|------------|---------------|
| RES10-ABR | W: 10" | H: 10" | Wire: 100" | Med. 200W A21 |
| RES10-GA | W: 10" | H: 10" | Wire: 100" | Med. 200W A21 |
| RES10-SB | W: 10" | H: 10" | Wire: 100" | Med. 200W A21 |
| RES10-SG | W: 10" | H: 10" | Wire: 100" | Med. 200W A21 |
| RES10-SR | W: 10" | H: 10" | Wire: 100" | Med. 200W A21 |
| RES10-WH | W: 10" | H: 10" | Wire: 100" | Med. 200W A21 |

WIRE GUARDS

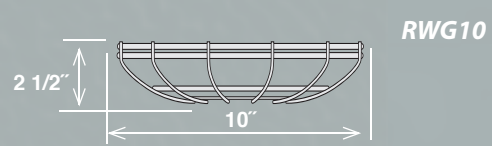

| | |
|-----------|--------|
| RWG10-ABR | W: 10" |
| RWG10-GA | W: 10" |
| RWG10-SB | W: 10" |
| RWG10-SG | W: 10" |
| RWG10-SR | W: 10" |
| RWG10-WH | W: 10" |

R SERIES



RES10-SR
Shade Only.
Shown with optional
RGN15-SR Goose Neck

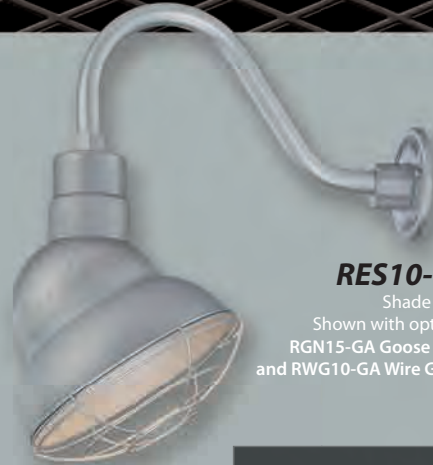

RES10-GA
Shade Only.
Shown with optional
RGN15-GA Goose Neck
and RWG10-GA Wire Guard



RES10-ABR
Shade Only.
Shown with optional
RGN15-ABR Goose Neck

Galvanized finishes may be inconsistent

EASY TO ORDER:

1. Choose a Shade
2. Choose a Goose Neck for Wall Mount **OR** Choose a Stem & Canopy Kit for Ceiling Mount
3. Wire Guard Optional

GOOSE NECKS (Actual Photos Shown on Page 238)

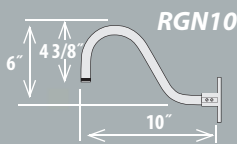

| | | |
|------------------|----------|-------|
| RGN10-ABR | ID: 3/4" | L:10" |
| RGN10-GA | ID: 3/4" | L:10" |
| RGN10-SB | ID: 3/4" | L:10" |
| RGN10-SG | ID: 3/4" | L:10" |
| RGN10-SR | ID: 3/4" | L:10" |
| RGN10-WH | ID: 3/4" | L:10" |

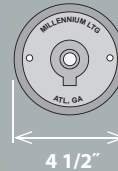

Back Plate included with goose neck

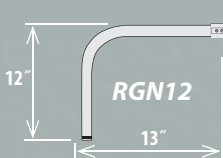

| | | |
|------------------|----------|-------|
| RGN12-ABR | ID: 3/4" | L:13" |
| RGN12-GA | ID: 3/4" | L:13" |
| RGN12-SB | ID: 3/4" | L:13" |
| RGN12-SG | ID: 3/4" | L:13" |
| RGN12-SR | ID: 3/4" | L:13" |
| RGN12-WH | ID: 3/4" | L:13" |

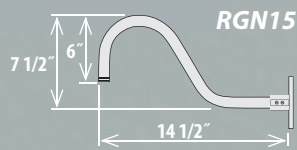

| | | |
|------------------|----------|-----------|
| RGN15-ABR | ID: 3/4" | L:14 1/2" |
| RGN15-GA | ID: 3/4" | L:14 1/2" |
| RGN15-SB | ID: 3/4" | L:14 1/2" |
| RGN15-SG | ID: 3/4" | L:14 1/2" |
| RGN15-SR | ID: 3/4" | L:14 1/2" |
| RGN15-WH | ID: 3/4" | L:14 1/2" |

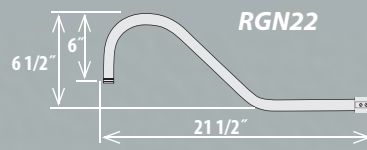

| | | |
|------------------|----------|-----------|
| RGN22-ABR | ID: 3/4" | L:21 1/2" |
| RGN22-GA | ID: 3/4" | L:21 1/2" |
| RGN22-SB | ID: 3/4" | L:21 1/2" |
| RGN22-SG | ID: 3/4" | L:21 1/2" |
| RGN22-SR | ID: 3/4" | L:21 1/2" |
| RGN22-WH | ID: 3/4" | L:21 1/2" |

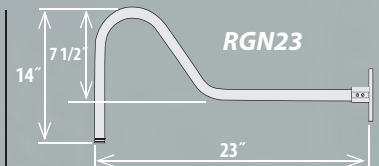

| | | |
|------------------|----------|-------|
| RGN23-ABR | ID: 3/4" | L:23" |
| RGN23-GA | ID: 3/4" | L:23" |
| RGN23-SB | ID: 3/4" | L:23" |
| RGN23-SG | ID: 3/4" | L:23" |
| RGN23-SR | ID: 3/4" | L:23" |
| RGN23-WH | ID: 3/4" | L:23" |

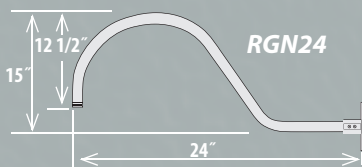

| | | |
|------------------|----------|-------|
| RGN24-ABR | ID: 3/4" | L:24" |
| RGN24-GA | ID: 3/4" | L:24" |
| RGN24-SB | ID: 3/4" | L:24" |
| RGN24-SG | ID: 3/4" | L:24" |
| RGN24-SR | ID: 3/4" | L:24" |
| RGN24-WH | ID: 3/4" | L:24" |

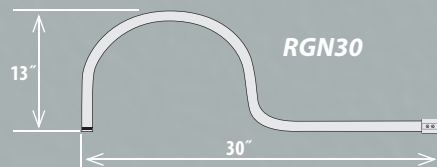

| | | |
|------------------|----------|-------|
| RGN30-ABR | ID: 3/4" | L:30" |
| RGN30-GA | ID: 3/4" | L:30" |
| RGN30-SB | ID: 3/4" | L:30" |
| RGN30-SG | ID: 3/4" | L:30" |
| RGN30-SR | ID: 3/4" | L:30" |
| RGN30-WH | ID: 3/4" | L:30" |

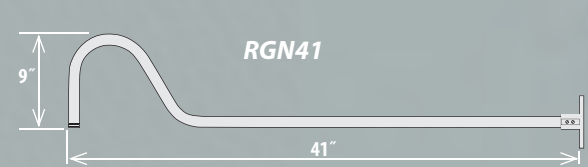

| | | |
|------------------|----------|-------|
| RGN41-ABR | ID: 3/4" | L:41" |
| RGN41-GA | ID: 3/4" | L:41" |
| RGN41-SB | ID: 3/4" | L:41" |
| RGN41-SG | ID: 3/4" | L:41" |
| RGN41-SR | ID: 3/4" | L:41" |
| RGN41-WH | ID: 3/4" | L:41" |

1 & 2 LIGHT POST ADAPTERS

RPAS -SR



RPAS -SG



RPAS -WH



RPAS -CP
Single Post Adapter Only.
Shown with optional RRRS18-CP Railroad Shade

RPAS -SB



RPAS -GA



RPAS -ABR



- Finishes:**
Architectural Bronze - ABR
Copper - CP
Galvanized - GA
Satin Black - SB
Satin Green - SG
Satin Red - SR
White - WH

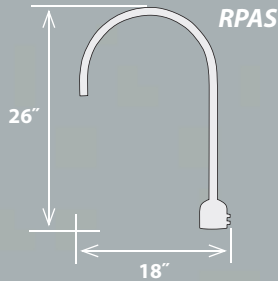

| | | |
|----------|--------|--------|
| RPAS-ABR | W: 18" | H: 26" |
| RPAS-CP | W: 18" | H: 26" |
| RPAS-GA | W: 18" | H: 26" |
| RPAS-SB | W: 18" | H: 26" |
| RPAS-SG | W: 18" | H: 26" |
| RPAS-SR | W: 18" | H: 26" |
| RPAS-WH | W: 18" | H: 26" |

Post adapters are designed to fit standard 3" posts and pier mount bases. Post and/or pier mount bases are not available from Millennium Lighting.

RPAD -CP

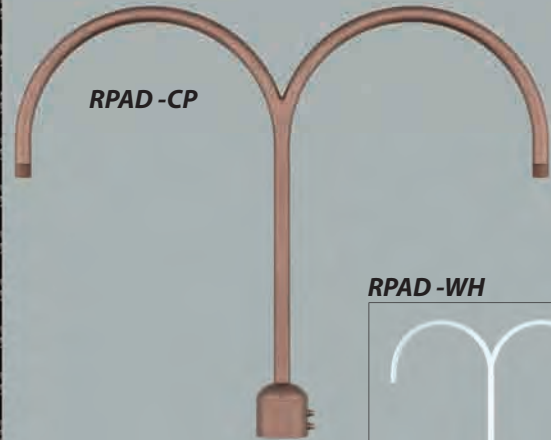

RPAD -GA



RPAD -SB



RPAD -SG



RPAD -WH



RPAD -ABR

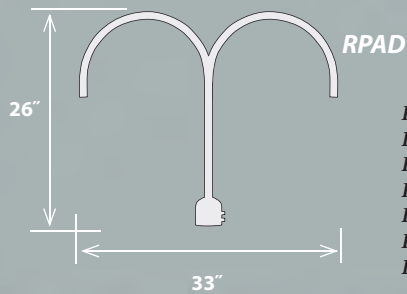

| | | |
|----------|--------|--------|
| RPAD-ABR | W: 33" | H: 26" |
| RPAD-CP | W: 33" | H: 26" |
| RPAD-GA | W: 33" | H: 26" |
| RPAD-SB | W: 33" | H: 26" |
| RPAD-SG | W: 33" | H: 26" |
| RPAD-SR | W: 33" | H: 26" |
| RPAD-WH | W: 33" | H: 26" |

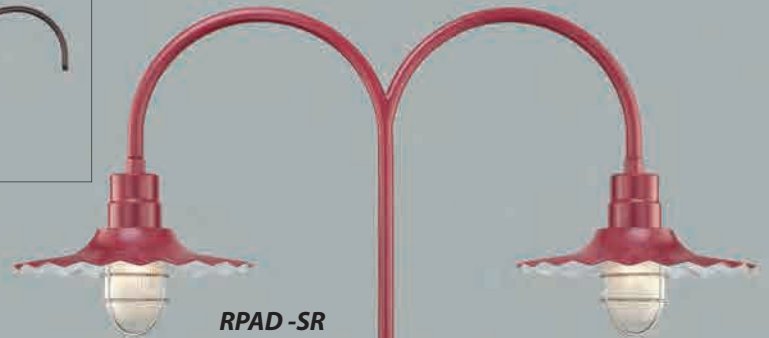

RPAD -SR
Double Post Adapter Only.
Shown with optional RRWS18-SR Radial Wave Shades

SPECIAL APPLICATION ACCESSORIES

R SERIES

STEEP SLOPE CANOPY KITS (45° MAX)

RSCKSS-SG



RSCKSS-ABR



RSCKSS-CP



RSCKSS-WH



RSCKSS-GA



RSCKSS-SB

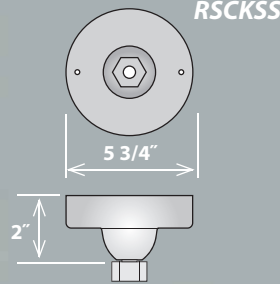

| | | |
|------------|-----------|-------|
| RSCKSS-ABR | W: 5 3/4" | H: 2" |
| RSCKSS-CP | W: 5 3/4" | H: 2" |
| RSCKSS-GA | W: 5 3/4" | H: 2" |
| RSCKSS-SB | W: 5 3/4" | H: 2" |
| RSCKSS-SG | W: 5 3/4" | H: 2" |
| RSCKSS-SR | W: 5 3/4" | H: 2" |
| RSCKSS-WH | W: 5 3/4" | H: 2" |

Required for stem hung ceiling applications where slope angle is greater than 25°.



RSCKSS-SR

Finishes:
 Architectural Bronze - ABR
 Copper - CP
 Galvanized - GA
 Satin Black - SB
 Satin Green - SG
 Satin Red - SR
 White - WH

STEM CONNECTORS

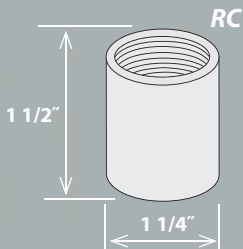

Accepts 3/4" stem.

| | | | |
|--------|--------|-----------|--------|
| RC-ABR | ID: 1" | W: 1 1/4" | L: 10" |
| RC-CP | ID: 1" | W: 1 1/4" | L: 10" |
| RC-GA | ID: 1" | W: 1 1/4" | L: 10" |
| RC-SB | ID: 1" | W: 1 1/4" | L: 10" |
| RC-SG | ID: 1" | W: 1 1/4" | L: 10" |
| RC-SR | ID: 1" | W: 1 1/4" | L: 10" |
| RC-WH | ID: 1" | W: 1 1/4" | L: 10" |

Required to couple stems for lengths exceeding 36".

Use of RC connectors or RSW Swivels in outdoor applications may require pipe sealant or plumber's putty. Please refer to local codes.

RC-GA



RC-ABR



RC-WH



RC-SB



RC-SR



RC-SG



RC-CP

WALL MOUNT SWIVELS

RSW-ABR



RSW-CP



RSW-GA



RSW-SG



RSW-SR



RSW-WH

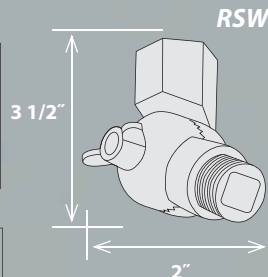

| | | |
|---------|-------|-----------|
| RSW-ABR | W: 2" | H: 3 1/2" |
| RSW-CP | W: 2" | H: 3 1/2" |
| RSW-GA | W: 2" | H: 3 1/2" |
| RSW-SB | W: 2" | H: 3 1/2" |
| RSW-SG | W: 2" | H: 3 1/2" |
| RSW-SR | W: 2" | H: 3 1/2" |
| RSW-WH | W: 2" | H: 3 1/2" |

Use of RC connectors or RSW Swivels in outdoor applications may require pipe sealant or plumber's putty. Please refer to local codes.

Allows precise angle adjustment of wall mounted shades.

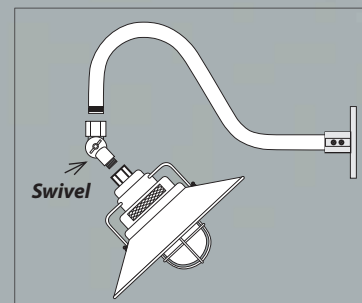

RSW-SB



14" - 18" CORD HUNG PENDANTS



RRRC18-GA

Galvanized finishes may be inconsistent



RRRC18-ABR

RRRC18-CP

RRRC18-SB



Finishes:

Architectural Bronze - ABR

Copper - CP

Galvanized - GA

Satin Black - SB

Multi-step painted copper finish is uniform on inside and outside areas of shade

18" RAILROAD SHADES

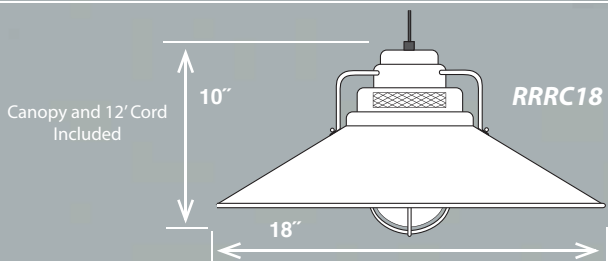

RRRC18-ABR W: 18" H:10" Wire: 144" Med. 100W A19

RRRC18-CP W: 18" H:10" Wire: 144" Med. 100W A19

RRRC18-GA W: 18" H:10" Wire: 144" Med. 100W A19

RRRC18-SB W: 18" H:10" Wire: 144" Med. 100W A19

RRRC14-SB



RRRC14-GA

Galvanized finishes may be inconsistent



RRRC14-ABR



RRRC14-CP

Multi-step painted copper finish is uniform on inside and outside areas of shade



14" RAILROAD SHADES

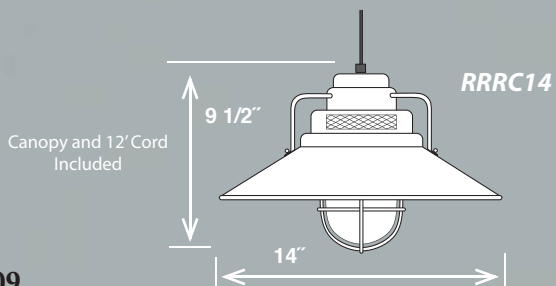

RRRC14-ABR W: 14" H: 9 1/2" Wire: 144" Med. 100W A19

RRRC14-CP W: 14" H: 9 1/2" Wire: 144" Med. 100W A19

RRRC14-GA W: 14" H: 9 1/2" Wire: 144" Med. 100W A19

RRRC14-SB W: 14" H: 9 1/2" Wire: 144" Med. 100W A19



RRWC18-GA

Galvanized finishes may be inconsistent

RRWC18-CP

Multi-step painted copper finish is uniform on inside and outside areas of shade

RRWC18-ABR

Finishes:

- Architectural Bronze - ABR
- Copper - CP
- Galvanized - GA
- Satin Black - SB
- Satin Green - SG
- Satin Red - SR
- White - WH

RRWC18-WH

RRWC18-SR

RRWC18-SG

RRWC18-SB

18" RADIAL WAVE SHADES

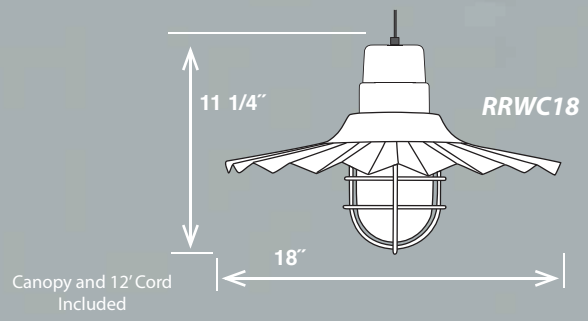

| | | | | |
|------------|--------|------------|------------|---------------|
| RRWC18-ABR | W: 18" | H: 11 1/4" | Wire: 144" | Med. 100W A19 |
| RRWC18-CP | W: 18" | H: 11 1/4" | Wire: 144" | Med. 100W A19 |
| RRWC18-GA | W: 18" | H: 11 1/4" | Wire: 144" | Med. 100W A19 |
| RRWC18-SB | W: 18" | H: 11 1/4" | Wire: 144" | Med. 100W A19 |
| RRWC18-SG | W: 18" | H: 11 1/4" | Wire: 144" | Med. 100W A19 |
| RRWC18-SR | W: 18" | H: 11 1/4" | Wire: 144" | Med. 100W A19 |
| RRWC18-WH | W: 18" | H: 11 1/4" | Wire: 144" | Med. 100W A19 |

12" - 15" CORD HUNG PENDANTS



RRWC15-WH

RRWC15-SR

RRWC15-SB

Finishes:

- Architectural Bronze - ABR
- Copper - CP
- Galvanized - GA
- Satin Black - SB
- Satin Green - SG
- Satin Red - SR
- White - WH



RRWC15-SG

RRWC15-GA

Galvanized finishes may be inconsistent



RRWC15-CP

Multi-step painted copper finish is uniform on inside and outside areas of shade



RRWC15-ABR



15" RAILROAD SHADES

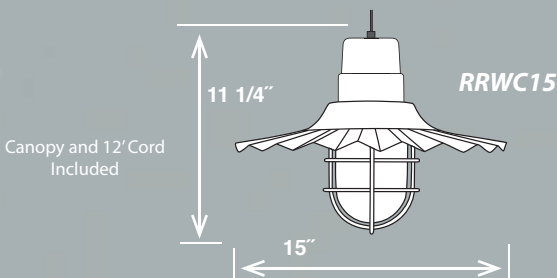

| | | | | |
|-------------------|--------|------------|------------|---------------|
| RRWC15-ABR | W: 15" | H: 11 1/4" | Wire: 144" | Med. 100W A19 |
| RRWC15-CP | W: 15" | H: 11 1/4" | Wire: 144" | Med. 100W A19 |
| RRWC15-GA | W: 15" | H: 11 1/4" | Wire: 144" | Med. 100W A19 |
| RRWC15-SB | W: 15" | H: 11 1/4" | Wire: 144" | Med. 100W A19 |
| RRWC15-SG | W: 15" | H: 11 1/4" | Wire: 144" | Med. 100W A19 |
| RRWC15-SR | W: 15" | H: 11 1/4" | Wire: 144" | Med. 100W A19 |
| RRWC15-WH | W: 15" | H: 11 1/4" | Wire: 144" | Med. 100W A19 |

R SERIES



Finishes:
 Architectural Bronze - ABR
 Copper - CP
 Galvanized - GA
 Satin Black - SB
 Satin Green - SG
 Satin Red - SR
 White - WH



12" RADIAL WAVE SHADES

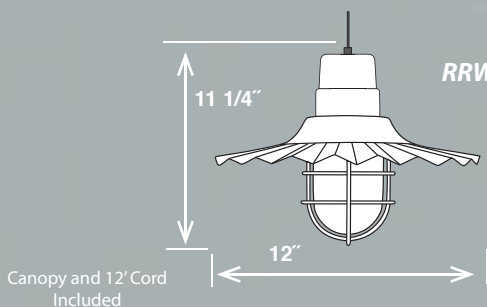

| | | | | |
|-------------------|--------|------------|------------|---------------|
| RRWC12-ABR | W: 12" | H: 11 1/4" | Wire: 144" | Med. 100W A19 |
| RRWC12-CP | W: 12" | H: 11 1/4" | Wire: 144" | Med. 100W A19 |
| RRWC12-GA | W: 12" | H: 11 1/4" | Wire: 144" | Med. 100W A19 |
| RRWC12-SB | W: 12" | H: 11 1/4" | Wire: 144" | Med. 100W A19 |
| RRWC12-SG | W: 12" | H: 11 1/4" | Wire: 144" | Med. 100W A19 |
| RRWC12-SR | W: 12" | H: 11 1/4" | Wire: 144" | Med. 100W A19 |
| RRWC12-WH | W: 12" | H: 11 1/4" | Wire: 144" | Med. 100W A19 |

14" - 17" CORD HUNG PENDANTS

Finishes:

- Architectural Bronze - ABR
- Galvanized - GA
- Satin Black - SB
- Satin Green - SG
- Satin Red - SR
- White - WH

RWHC17-SG

Shown with optional
RWG17-SG Wire Guard

RWHC17-SB

RWHC17-GA

Galvanized finishes may
be inconsistent

RWHC17-ABR

RWHC17-SR

RWHC17-WH

17" WAREHOUSE SHADES

WIRE GUARDS

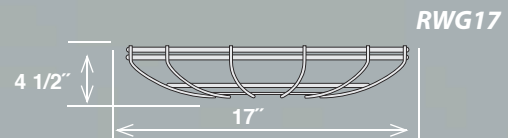
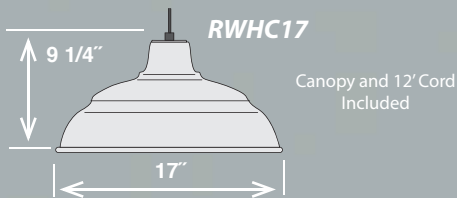

| | | |
|------------|------------------|--------------------------|
| RWHC17-ABR | W: 17" H: 9 1/4" | Wire: 144" Med. 100W A21 |
| RWHC17-GA | W: 17" H: 9 1/4" | Wire: 144" Med. 100W A21 |
| RWHC17-SB | W: 17" H: 9 1/4" | Wire: 144" Med. 100W A21 |
| RWHC17-SG | W: 17" H: 9 1/4" | Wire: 144" Med. 100W A21 |
| RWHC17-SR | W: 17" H: 9 1/4" | Wire: 144" Med. 100W A21 |
| RWHC17-WH | W: 17" H: 9 1/4" | Wire: 144" Med. 100W A21 |

| | |
|-----------|------------------|
| RWG17-ABR | W: 17" H: 4 1/2" |
| RWG17-GA | W: 17" H: 4 1/2" |
| RWG17-SB | W: 17" H: 4 1/2" |
| RWG17-SG | W: 17" H: 4 1/2" |
| RWG17-SR | W: 17" H: 4 1/2" |
| RWG17-WH | W: 17" H: 4 1/2" |

R SERIES



RWHC14-GA

Galvanized finishes may be inconsistent

Shown with optional RWG14-GA Wire Guard



RWHC14-WH

Shown with optional RWG14-WH Wire Guard



RWHC14-SR

Finishes:

- Architectural Bronze - ABR
- Copper - CP
- Galvanized - GA
- Satin Black - SB
- Satin Green - SG
- Satin Red - SR
- White - WH



RWHC14-SB



RWHC14-ABR



RWHC14-SG

14" WAREHOUSE SHADES

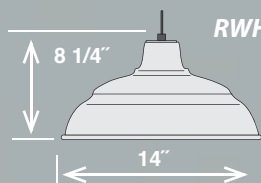

RWHC14

Canopy and 12' Cord Included

WIRE GUARDS

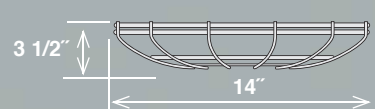

RWG14

| | |
|------------|---|
| RWHC14-ABR | W: 14" H: 9 1/4" Wire: 144" Med. 100W A21 |
| RWHC14-GA | W: 14" H: 9 1/4" Wire: 144" Med. 100W A21 |
| RWHC14-SB | W: 14" H: 9 1/4" Wire: 144" Med. 100W A21 |
| RWHC14-SG | W: 14" H: 9 1/4" Wire: 144" Med. 100W A21 |
| RWHC14-SR | W: 14" H: 9 1/4" Wire: 144" Med. 100W A21 |
| RWHC14-WH | W: 14" H: 9 1/4" Wire: 144" Med. 100W A21 |

| | |
|-----------|------------------|
| RWG14-ABR | W: 14" H: 3 1/2" |
| RWG14-GA | W: 14" H: 3 1/2" |
| RWG14-SB | W: 14" H: 3 1/2" |
| RWG14-SG | W: 14" H: 3 1/2" |
| RWG14-SR | W: 14" H: 3 1/2" |
| RWG14-WH | W: 14" H: 3 1/2" |

10" - 12" CORD HUNG PENDANTS



RDBC12-SB

Shown with optional
RWG12-SB Wire Guard



RDBC12-SR



RDBC12-SG

Finishes:

Architectural Bronze - ABR

Galvanized - GA

Satin Black - SB

Satin Green - SG

Satin Red - SR

White - WH



RDBC12-GA

Galvanized finishes may
be inconsistant

Shown with optional
RWG 12-GA Wire Guard



RDBC12-WH



RDBC12-ABR

12" DEEP BOWL SHADES

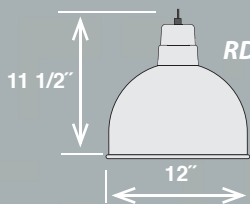

RDBC12

Canopy and 12' Cord
Included

WIRE GUARDS

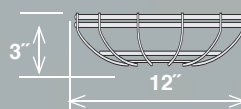

RWG12

| | |
|-------------------|--|
| RDBC12-ABR | W: 12" H: 11 1/2" Wire: 144" Med. 100W A21 |
| RDBC12-GA | W: 12" H: 11 1/2" Wire: 144" Med. 100W A21 |
| RDBC12-SB | W: 12" H: 11 1/2" Wire: 144" Med. 100W A21 |
| RDBC12-SG | W: 12" H: 11 1/2" Wire: 144" Med. 100W A21 |
| RDBC12-SR | W: 12" H: 11 1/2" Wire: 144" Med. 100W A21 |
| RDBC12-WH | W: 12" H: 11 1/2" Wire: 144" Med. 100W A21 |

| | |
|------------------|--------------|
| RWG12-ABR | W: 12" H: 3" |
| RWG12-GA | W: 12" H: 3" |
| RWG12-SB | W: 12" H: 3" |
| RWG12-SG | W: 12" H: 3" |
| RWG12-SR | W: 12" H: 3" |
| RWG12-WH | W: 12" H: 3" |

R SERIES

RDBC10-ABR

Shown with optional
RWG10-ABR Wire Guard



RDBC10-GA

Galvanized finishes may
be inconsistent



RDBC10-SB



Finishes:

- Architectural Bronze - ABR
- Galvanized - GA
- Satin Black - SB
- Satin Green - SG
- Satin Red - SR
- White - WH

RDBC10-SG



RDBC10-WH



RDBC10-SR



10" DEEP BOWL SHADES

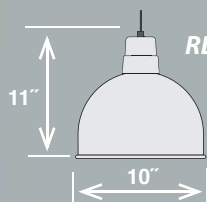

RDBC 10

Canopy and 12' Cord
Included

WIRE GUARDS

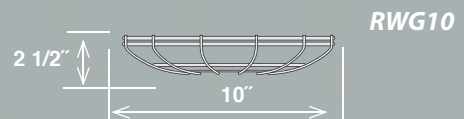

RWG10

| | | | | |
|------------|--------|--------|------------|---------------|
| RDBC10-ABR | W: 10" | H: 11" | Wire: 144" | Med. 100W A21 |
| RDBC10-GA | W: 10" | H: 11" | Wire: 144" | Med. 100W A21 |
| RDBC10-SB | W: 10" | H: 11" | Wire: 144" | Med. 100W A21 |
| RDBC10-SG | W: 10" | H: 11" | Wire: 144" | Med. 100W A21 |
| RDBC10-SR | W: 10" | H: 11" | Wire: 144" | Med. 100W A21 |
| RDBC10-WH | W: 10" | H: 11" | Wire: 144" | Med. 100W A21 |

| | | |
|-----------|--------|-----------|
| RWG10-ABR | W: 10" | H: 2 1/2" |
| RWG10-GA | W: 10" | H: 2 1/2" |
| RWG10-SB | W: 10" | H: 2 1/2" |
| RWG10-SG | W: 10" | H: 2 1/2" |
| RWG10-SR | W: 10" | H: 2 1/2" |
| RWG10-WH | W: 10" | H: 2 1/2" |

8" WAREHOUSE SHADE WALL BRACKETS



RWHWB8-SR

RWHWB8-SG



Finishes:

Architectural Bronze - ABR

Galvanized - GA

Satin Black - SB

Satin Green - SG

Satin Red - SR

White - WH

RWHWB8-GA

Galvanized finishes may be inconsistent



RWHWB8-SB

RWHWB8-ABR



RWHWB8-WH



Removable Wire Guard Included

8" WAREHOUSE SHADE WALL BRACKET

RWHWB8

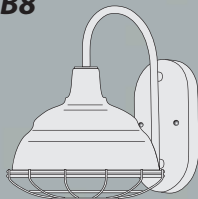

| | | | | |
|------------|-------|------------|----------|---------------|
| RWHWB8-ABR | W: 8" | H: 11 3/4" | Ext: 11" | Med. 100W A19 |
| RWHWB8-GA | W: 8" | H: 11 3/4" | Ext: 11" | Med. 100W A19 |
| RWHWB8-SB | W: 8" | H: 11 3/4" | Ext: 11" | Med. 100W A19 |
| RWHWB8-SG | W: 8" | H: 11 3/4" | Ext: 11" | Med. 100W A19 |
| RWHWB8-SR | W: 8" | H: 11 3/4" | Ext: 11" | Med. 100W A19 |
| RWHWB8-WH | W: 8" | H: 11 3/4" | Ext: 11" | Med. 100W A19 |

R SERIES

5390 GA



5390 SB



5390 ABR



9" WALL BRACKET

5390

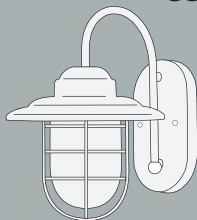

| | | | | |
|----------|-----------|------------|----------|---------------|
| 5390-ABR | W: 8 1/2" | H: 11 1/2" | Ext: 11" | Med. 100W A19 |
| 5390-GA | W: 8 1/2" | H: 11 1/2" | Ext: 11" | Med. 100W A19 |
| 5390-SB | W: 8 1/2" | H: 11 1/2" | Ext: 11" | Med. 100W A19 |

NEO INDUSTRIAL:

Industrial styles updated in popular finishes for residential and commercial applications. All Neo Industrial fixtures are UL damp listed and are packaged with all required hanging parts.



NEO INDUSTRIAL

All Neo Industrial style hanging fixtures are stem hung and supplied with the following three sections: 18", 12" and 6". Length of wire will allow for (2) additional 12" rods.

Stem hung fixtures may be semi-flush mounted by removing all stems.

The ball mount hanging system will swivel up to 60 degrees.

Suitable for damp locations.

Compatible with integrated CFL's.



CROSSCUT GLASS SERIES



Finishes:
Rubbed Bronze - RBZ

Glass:
Clear Crosscut

All Neo Industrial style hanging fixtures are stem hung and supplied with the following three sections: 18", 12" and 6". Length of wire will allow for (2) additional 12" rods.

Stem hung fixtures may be semi-flush mounted by removing all stems.

The ball mount hanging system will swivel up to 60 degrees.

Suitable for damp locations.

Compatible with integrated CFL's.

5343 RBZ

Wall Sconce



5341 RBZ



CROSSCUT GLASS SERIES

| | | |
|-----------------|-----------------------------|--------------------|
| 5341 RBZ | W: 10 1/2" H: 8" | Ext: 5" 1-Med. 75A |
| 5343 RBZ | W: 41" H: 53 1/2" Body: 16" | 3-Med. 100A |

NEO INDUSTRIAL



5331 RBZ



5333 RBZ

5331 RBZ W: 10" H: 46 1/2" Body: 8 3/4" 1-Med. 100A
5333 RBZ W: 27" H: 53 1/2" Body: 16" 3-Med. 100A

CROSSCUT GLASS SERIES



Wall Sconce



5343 SN

5341 SN

Finishes:
Satin Nickel - SN

Glass:
Clear Crosscut

All Neo Industrial style hanging fixtures are stem hung and supplied with the following three sections: 18", 12" and 6". Length of wire will allow for (2) additional 12" rods.

Stem hung fixtures may be semi-flush mounted by removing all stems.

The ball mount hanging system will swivel up to 60 degrees.

Suitable for damp locations.

Compatible with integrated CFL's.



CROSSCUT GLASS SERIES

| | | | | | |
|---------|------------|------------|-----------|---------|-------------|
| 5341 SN | W: 10 1/2" | H: 8" | | Ext: 5" | 1-Med. 75A |
| 5343 SN | W: 41" | H: 53 1/2" | Body: 16" | | 3-Med. 100A |

NEO INDUSTRIAL



5331 SN



5333 SN

5331 SN W: 10" H: 46 1/2" Body: 8 3/4" 1-Med. 100A
5333 SN W: 27" H: 53 1/2" Body: 16" 3-Med. 100A

WIRE GUARD SERIES



5301 RBZ

5313 RBZ

Finishes:
Rubbed Bronze - RBZ

All Neo Industrial style hanging fixtures are stem hung and supplied with the following three sections: 18", 12" and 6". Length of wire will allow for (2) additional 12" rods.

Stem hung fixtures may be semi-flush mounted by removing all stems.

The ball mount hanging system will swivel up to 60 degrees.

Suitable for damp locations.

Compatible with integrated CFL's.



WIRE GUARD SERIES

| | | | | |
|-----------------|------------|------------|--------------|--------------------|
| 5301 RBZ | W: 10 1/4" | H: 47 3/4" | Body: 9 3/4" | 1-Med. 100W |
| 5313 RBZ | W: 10 1/4" | H: 55" | Body: 17" | L: 41" 3-Med. 100W |

NEO INDUSTRIAL



5303 RBZ



5311 RBZ



| | | | | |
|-----------------|-----------|------------|---------------|--------------------------|
| 5303 RBZ | W: 27" | H: 54" | Body: 16" | 3-Med. 100W |
| 5311 RBZ | W: 17" | H: 51 1/2" | Body: 13 1/2" | 1-Med. 150W |
| 5321 RBZ | W: 8 1/4" | H: 11 1/2" | Body: - | Ext: 10 3/4" 1-Med. 100W |

WIRE GUARD SERIES



5301 SN

5313 SN



Finishes:
Satin Nickel - SN

All Neo Industrial style hanging fixtures are stem hung and supplied with the following three sections: 18", 12" and 6". Length of wire will allow for (2) additional 12" rods.

Stem hung fixtures may be semi-flush mounted by removing all stems.

The ball mount hanging system will swivel up to 60 degrees.

Suitable for damp locations.

Compatible with integrated CFL's.



WIRE GUARD SERIES

| | | | | |
|----------------|------------|------------|--------------|--------------------|
| 5301 SN | W: 10 1/4" | H: 47 3/4" | Body: 9 3/4" | 1-Med. 100W |
| 5313 SN | W: 10 1/4" | H: 55" | Body: 17" | L: 41" 3-Med. 100W |

NEO INDUSTRIAL



5321 SN



5303 SN



5311 SN



| | | | | |
|----------------|-----------|------------|---------------|-------------|
| 5303 SN | W: 27" | H: 54" | Body: 16" | 3-Med. 100W |
| 5311 SN | W: 17" | H: 51 1/2" | Body: 13 1/2" | 1-Med. 150W |
| 5321 SN | W: 8 1/4" | H: 11 1/2" | Ext: 10 3/4" | 1-Med. 100W |

SCHOOLHOUSE GLASS SERIES



5351 RBZ

5363 RBZ

Finishes:

Rubbed Bronze - RBZ

Glass:

Opal White Schoolhouse

All Neo Industrial style hanging fixtures are stem hung and supplied with the following three sections: 18", 12" and 6". Length of wire will allow for (2) additional 12" rods.

Stem hung fixtures may be semi-flush mounted by removing all stems.

The ball mount hanging system will swivel up to 60 degrees.

Suitable for damp locations.

Compatible with integrated CFL's.



SCHOOLHOUSE GLASS SERIES

| | | | | |
|-----------------|------------|------------|---------------|-------------|
| 5351 RBZ | W: 9 1/2" | H: 46 1/2" | Body: 8" | 1-Med. 100A |
| 5363 RBZ | W: 40 1/2" | H: 54" | Body: 15 1/2" | 3-Med. 100A |

NEO INDUSTRIAL



5371 RBZ



5353 RBZ



5361 RBZ

| | | | | |
|-----------------|--------|--------|-----------|-------------|
| 5353 RBZ | W: 26" | H: 53" | Body: 16" | 3-Med. 100A |
| 5361 RBZ | W: 15" | H: 51" | Body: 13" | 1-Med. 150A |
| 5371 RBZ | W: 7" | H: 10" | Ext: 9" | 1-Med. 60A |

SCHOOLHOUSE GLASS SERIES



5351 CH



5363 CH



Finishes:
Chrome - CH

Glass:
Opal White Schoolhouse

All Neo Industrial style hanging fixtures are stem hung and supplied with the following three sections: 18", 12" and 6". Length of wire will allow for (2) additional 12" rods.

Stem hung fixtures may be semi-flush mounted by removing all stems.

The ball mount hanging system will swivel up to 60 degrees.

Suitable for damp locations.

Compatible with integrated CFL's.



SCHOOLHOUSE GLASS SERIES

| | | | | |
|----------------|------------|------------|---------------|-------------|
| 5351 CH | W: 9 1/2" | H: 46 1/2" | Body: 8" | 1-Med. 100A |
| 5363 CH | W: 40 1/2" | H: 54" | Body: 15 1/2" | 3-Med. 100A |

NEO INDUSTRIAL



5371 CH



5353 CH



5361 CH

| | | | | |
|----------------|--------|--------|-----------|-------------|
| 5353 CH | W: 26" | H: 53" | Body: 16" | 3-Med. 100A |
| 5361 CH | W: 15" | H: 51" | Body: 13" | 1-Med. 150A |
| 5371 CH | W: 7" | H: 10" | Ext: 9" | 1-Med. 60A |

SCHOOLHOUSE GLASS SERIES



Finishes:
Copper - CP

Glass:
Opal White Schoolhouse

All Neo Industrial style hanging fixtures are stem hung and supplied with the following three sections: 18", 12" and 6". Length of wire will allow for (2) additional 12" rods.

Stem hung fixtures may be semi-flush mounted by removing all stems.

The ball mount hanging system will swivel up to 60 degrees.

Suitable for damp locations.

Compatible with integrated CFL's.



5351 CP



5361 CP



5371 CP

SCHOOLHOUSE GLASS SERIES

| | | | | |
|----------------|-----------|------------|-----------|-------------|
| 5351 CP | W: 9 1/2" | H: 46 1/2" | Body: 8" | 1-Med. 100A |
| 5361 CP | W: 15" | H: 51" | Body: 13" | 1-Med. 150A |
| 5371 CP | W: 7" | H: 10" | Ext. 9" | 1-Med. 60A |

MINI-PENDANT

NEO INDUSTRIAL

Finishes:

Brushed Nickel - BN

Copper - CP

Rubbed Bronze - RBZ

Satin Nickel - SN

Glass:

Inside Etched



5391 CP



5391 SN



5391 RBZ



5370 RBZ



5370 BN

MINI-PENDANT

| | | | | |
|-----------------|-----------|------------|----------|-------------|
| 5370 BN | W: 11" | H: 49 1/2" | | 1-Med. 100W |
| 5370 RBZ | W: 11" | H: 49 1/2" | | 1-Med. 100W |
| 5391 CP | W: 8 1/2" | H: 47" | Body: 8" | 1-Med. 100A |
| 5391 RBZ | W: 8 1/2" | H: 47" | Body: 8" | 1-Med. 100A |
| 5391 SN | W: 8 1/2" | H: 47" | Body: 8" | 1-Med. 100A |

MINI-PENDANT



5381 CH

Finishes:

- Brushed Nickel - BN
- Chrome - CH
- Copper - CP
- Rubbed Bronze - RBZ

Glass:

- Clear Prismatic



5381 RBZ



5381 CP



MINI-PENDANT

| | | | | |
|----------|--------|--------|-----------|-------------|
| 5381 CH | W: 10" | H: 50" | Body: 12" | 1-Med. 100A |
| 5381 CP | W: 10" | H: 50" | Body: 12" | 1-Med. 100A |
| 5381 RBZ | W: 10" | H: 50" | Body: 12" | 1-Med. 100A |

NEO INDUSTRIAL



5380 BN



5380 RBZ

All Neo Industrial style hanging fixtures are stem hung and supplied with the following three sections: 18", 12" and 6". Length of wire will allow for (2) additional 12" rods.

Stem hung fixtures may be semi-flush mounted by removing all stems.

The ball mount hanging system will swivel up to 60 degrees.

Suitable for damp locations.

Compatible with integrated CFL's.

5380 BN W: 11" H: 47" Body: - 8" 1-Med. 100A

5380 RBZ W: 11" H: 47" Body: - 8" 1-Med. 100A

FINISHES

| FINISH | FINISH DESCRIPTION | METHOD |
|---------------|---|---------------|
| ABR | Architectural Bronze - UV Protectant (aka: Espresso) | Painted |
| AP | Antique Pewter: Silver with charcoal overlay | Painted |
| AW/BZ | Multi-step Antique White / Multi-step Bronze | Painted |
| BB/S | Burled Bronze/Silver: Burled bronze w/silver highlights | Painted |
| BG | Burnished Gold: Charcoal with gold overlay | Painted |
| BK | Black: Matte black | Painted |
| BN | Brushed Nickel | Plated |
| BZ | Bronze: 3-step bronze/brown basecoat | Painted |
| BZ/G | Bronze/Gold: Bronze w/gold highlights | Painted |
| CB | Colonial Bronze: Dark brushed bronze | Plated |
| CH | Chrome | Plated |
| CP | Two-Step Copper - UV Protectant | Painted |
| EB | Euro Bronze: Dark rubbed bronze | Painted |
| FTB | Fine Textured Black: Matte black | Painted |
| GA | Galvanized - UV Protectant Clear Coat | Plated |
| GR | Granite: Silver with charcoal overlay | Painted |
| KH | Khaki | Painted |
| PB | Polished Brass | Plated |
| PW | Pewter: Antique pewter | Plated |
| RBZ | Rubbed Bronze: Dark brushed bronze | Painted |
| RS | Rubbed Silver: 3-step rubbed silver | Painted |
| SB | Satin Black - UV Protectant | Painted |
| SG | Satin Green - UV Protectant (aka: Hunt Club Green) | Painted |
| SM | Silver Mist: 3-step bronze with gold and silver | Painted |
| SN | Satin Nickel: Brushed Nickel | Plated |
| SR | Satin Red - UV Protectant (aka: Colonial Red) | Painted |
| VI | Vintage Iron: 3-step pewter | Painted |
| WH | Indoor White: Matte white | Painted |
| WH | Outdoor White: Gloss white - UV Protectant | Painted |

Many of our metal and glass finishes are hand applied and are therefore subject to variance.

GOOSE NECKS



RGN10-ABR



RGN12-ABR



RGN15-ABR



RGN22-ABR



RGN23-ABR



RGN24-ABR

*These are actual photos of
Goose Necks Shown on
Pages 181-206*



RGN30-ABR



RGN41-ABR

INDEX

| <u>ITEM#</u> | <u>PAGE</u> | <u>ITEM#</u> | <u>PAGE</u> | <u>ITEM#</u> | <u>PAGE</u> | <u>ITEM#</u> | <u>PAGE</u> |
|--------------|-------------|--------------|-------------|--------------|-------------|--------------|-------------|
| 53 BK | 78 | 473 CB | 138 | 552 BZ | 156 | 663 BK | 90 |
| 53 SN | 77 | 475 CB | 138 | 552 SN | 156 | 663 SN/SM | 85 |
| 73 BK | 78 | 482 BZ | 140 | 561 BG | 153 | 663 VI | 92 |
| 73 SN | 77 | 482 CH | 139 | 561 BZ | 153 | 671 VI | 91 |
| 75 BK | 78 | 482 SN | 139 | 561 CH | 155 | 673 BK | 90 |
| 75 SN | 77 | 483 BZ | 140 | 561 FTB | 155 | 673 SN/SM | 88 |
| 76 BK | 78 | 483 CH | 139 | 561 KH | 155 | 673 VI | 92 |
| 76 SN | 77 | 483 SN | 139 | 561 PB | 155 | 675 BK | 90 |
| 79 BK | 78 | 485 BZ | 140 | 561 SN | 154 | 675 SN/SM | 86 |
| 79 SN | 77 | 485 CH | 139 | 561 WH | 155 | 675 VI | 92 |
| 112 SM | 118 | 485 SN | 139 | 561 VI | 154 | 679 BK | 89 |
| 113 SM | 118 | 486 SN | 139 | 563 BG | 153 | 679 SN/SM | 86 |
| 114 SM | 118 | 492 CH | 136 | 563 BZ | 153 | 679 VI | 91 |
| 142 BG | 118 | 492 SN | 136 | 563 CH | 155 | 721 WH | 176 |
| 143 BG | 118 | 493 CH | 136 | 563 FTB | 155 | 722 SN | 151 |
| 144 BG | 118 | 493 SN | 136 | 563 KH | 155 | 732 EB | 151 |
| 212 BG | 177 | 494 CH | 136 | 563 PB | 155 | 733 BG | 116 |
| 242 | 177 | 494 SN | 136 | 563 SN | 154 | 733 SN | 116 |
| 252 BG | 177 | 501 BZ | 156 | 563 WH | 155 | 742 SN | 146 |
| 252 SN | 177 | 501 CH | 156 | 563 VI | 154 | 743 AP | 115 |
| 253 BG | 169 | 501 SN | 156 | 565 BG | 153 | 743 BZ | 115 |
| 253 RBZ | 169 | 501 WH | 156 | 565 BZ | 153 | 743 SN | 115 |
| 253 SN | 169 | 502 BZ | 156 | 565 FTB | 155 | 752 EB | 146 |
| 301 SN | 144 | 502 CH | 156 | 565 KH | 155 | 753 BG | 115 |
| 302 SN | 144 | 502 SN | 156 | 565 PB | 155 | 783 BG | 50 |
| 303 SN | 144 | 502 WH | 156 | 565 SN | 154 | 786 BG | 49 |
| 304 SN | 144 | 511 BZ | 156 | 565 WH | 155 | 789 BG | 49 |
| 322 SN/GR | 138 | 511 CH | 156 | 565 VI | 154 | 793 AP | 110 |
| 323 SN/GR | 138 | 511 SN | 156 | 571 BZ | 149 | 793 BZ | 109 |
| 325 SN/GR | 138 | 511 WH | 156 | 571 SN | 149 | 793 SN | 110 |
| 331 CB | 143 | 512 BZ | 156 | 573 BZ | 149 | 796 AP | 110 |
| 331 CH | 143 | 512 CH | 156 | 573 SN | 149 | 796 BZ | 109 |
| 331 SN | 144 | 512 SN | 156 | 575 BZ | 149 | 796 SN | 110 |
| 332 CB | 143 | 512 WH | 156 | 575 SN | 149 | 902 BK | 58 |
| 332 CH | 143 | 513 BG | 81 | 581 WH | 176 | 903 BK | 57 |
| 332 SN | 144 | 513 SN/SM | 87 | 583 BZ | 114 | 906 BK | 57 |
| 333 CB | 143 | 515 BG | 82 | 583 SN | 114 | 909 BK | 58 |
| 333 CH | 143 | 515 SN/SM | 87 | 602 SN | 121 | 911 BG | 165 |
| 333 SN | 144 | 516 BG | 81 | 603 SN | 121 | 912 BG | 126 |
| 371 SN | 135 | 516 SN/SM | 87 | 604 SN | 121 | 913 BG | 126 |
| 372 SN | 135 | 519 BG | 82 | 612 EB | 122 | 914 BG | 126 |
| 373 SN | 135 | 519 SN/SM | 88 | 613 EB | 122 | 922 BG | 47 |
| 374 SN | 135 | 521 WH | 176 | 614 EB | 122 | 923 BG | 48 |
| 382 SN | 137 | 522 WH | 151 | 616 BK | 89 | 928 BG | 47 |
| 383 SN | 137 | 523 BG | 157 | 616 SN/SM | 85 | 933 BG | 48 |
| 385 SN | 137 | 532 WH | 151 | 616 VI | 91 | 951 SM | 165 |
| 412 CH | 141 | 534 WH | 151 | 622 CH | 121 | 952 SM | 4 |
| 412 SN | 141 | 541 BZ | 156 | 622 RBZ | 122 | 953 SM | 4 |
| 413 CH | 141 | 541 SN | 156 | 623 CH | 121 | 957 SM | 4 |
| 413 SN | 141 | 541 WH | 156 | 623 RBZ | 122 | 962 SM | 117 |
| 414 CH | 141 | 542 BZ | 156 | 624 CH | 121 | 963 SM | 117 |
| 414 SN | 141 | 542 SN | 156 | 624 RBZ | 122 | 964 SM | 117 |
| 472 CB | 138 | 542 WH | 156 | 653 VI | 92 | 971 BG | 105, 165 |

| <u>ITEM#</u> | <u>PAGE</u> | <u>ITEM#</u> | <u>PAGE</u> | <u>ITEM#</u> | <u>PAGE</u> | <u>ITEM#</u> | <u>PAGE</u> |
|--------------|-------------|--------------|-------------|--------------|-------------|--------------|-------------|
| 971 SN | 103, 165 | 1125 VI | 45 | 1284 RS | 128 | 1473 PW | 71 |
| 972 BG | 106 | 1129 VI | 44 | 1293 RBZ | 93 | 1481 PW | 69, 134 |
| 972 SN | 104 | 1133 VI | 44 | 1312 RBZ | 8 | 1482 PW | 134 |
| 973 BG | 105 | 1141 VI | 45, 166 | 1323 RBZ | 97, 116 | 1483 PW | 134 |
| 973 SN | 103 | 1144 RBZ | 24 | 1323 RS | 101, 116 | 1484 PW | 134 |
| 983 BG | 105 | 1153 RBZ | 23 | 1333 RBZ | 98 | 1493 PW | 72 |
| 983 SN | 103 | 1156 RBZ | 24 | 1333 RS | 102 | 1501 RBZ | 6, 158 |
| 992 AP | 104 | 1163 RBZ | 8, 145 | 1335 RBZ | 98 | 1502 RBZ | 6 |
| 992 SN | 104 | 1172 VI | 120 | 1335 RS | 102 | 1503 RBZ | 6 |
| 993 AP | 104 | 1173 VI | 120 | 1336 RBZ | 97 | 1505 RBZ | 5 |
| 993 SN | 104 | 1174 VI | 120 | 1336 RS | 101 | 1509 RBZ | 5 |
| 1001 RBZ | 39 | 1181 RBZ | 129 | 1351 RBZ | 10, 166 | 1511 RBZ | 5, 124 |
| 1003 RBZ | 41 | 1181 SN | 129 | 1361 RBZ | 95, 168 | 1512 RBZ | 6, 124 |
| 1005 RBZ | 42 | 1182 RBZ | 129 | 1361 RS | 99, 168 | 1513 RBZ | 124 |
| 1011 RBZ | 39 | 1182 SN | 129 | 1363 RBZ | 96 | 1514 RBZ | 124 |
| 1012 RBZ | 19 | 1183 RBZ | 129 | 1363 RS | 100 | 1601 RBZ | 162 |
| 1013 RBZ | 41 | 1183 SN | 129 | 1365 RBZ | 95 | 1601 SN | 61, 162 |
| 1016 RBZ | 39 | 1184 RBZ | 129 | 1365 RS | 100 | 1603 SN | 62 |
| 1021 RBZ | 39, 120 | 1184 SN | 129 | 1366 RBZ | 96 | 1606 SN | 62 |
| 1022 RBZ | 42 | 1193 RBZ | 94 | 1366 RS | 99 | 1611 RBZ | 161 |
| 1023 RBZ | 40 | 1201 RBZ | 27, 166 | 1369 RBZ | 95 | 1611 SN | 161 |
| 1025 RBZ | 41 | 1203 RBZ | 25 | 1369 RS | 100 | 1616 SN | 61 |
| 1029 RBZ | 40 | 1205 RBZ | 26 | 1373 RBZ | 96 | 1621 RBZ | 161 |
| 1033 RBZ | 40 | 1207 RBZ | 26 | 1373 RS | 100 | 1621 SN | 161 |
| 1041 RBZ | 41, 166 | 1211 RBZ | 25 | 1383 RBZ | 96 | 1631 SN | 62 |
| 1042 RBZ | 42, 150 | 1212 RBZ | 28 | 1383 RS | 99 | 1641 RBZ | 160 |
| 1043 RBZ | 42, 150 | 1213 RBZ | 28 | 1392 RBZ | 127 | 1641 SN | 160 |
| 1051 RBZ | 19 | 1214 RBZ | 29 | 1392 RS | 127 | 1651 RBZ | 160 |
| 1052 RBZ | 21 | 1215 RBZ | 27 | 1393 RBZ | 127 | 1651 SN | 160 |
| 1053 RBZ | 22 | 1216 RBZ | 93 | 1393 RS | 127 | 1661 RBZ | 160 |
| 1054 RBZ | 22 | 1218 RBZ | 29 | 1394 RBZ | 127 | 1661 SN | 160 |
| 1055 RBZ | 21 | 1221 RBZ | 25, 119 | 1394 RS | 127 | 1670 RBZ | 159 |
| 1056 RBZ | 23 | 1222 RBZ | 26, 119 | 1401 SN | 68, 162 | 1670 SN | 159 |
| 1059 RBZ | 20 | 1223 RBZ | 27 | 1403 SN | 68 | 1671 RBZ | 159 |
| 1063 RBZ | 21 | 1224 RBZ | 30 | 1405 SN | 68 | 1671 SN | 159 |
| 1072 RBZ | 120 | 1228 RBZ | 30 | 1409 SN | 68 | 1672 RBZ | 158 |
| 1073 RBZ | 120 | 1232 RBZ | 28 | 1412 SN | 67 | 1672 SN | 158 |
| 1074 RBZ | 120 | 1233 RBZ | 28 | 1413 PW | 71 | 1673 RBZ | 158 |
| 1081 RBZ | 20, 164 | 1242 RBZ | 119 | 1414 PW | 72 | 1673 SN | 158 |
| 1083 RBZ | 22 | 1243 RBZ | 119 | 1416 SN | 67 | 1674 RBZ | 159 |
| 1091 RBZ | 93, 168 | 1244 RBZ | 119 | 1423 SN | 67 | 1674 SN | 159 |
| 1093 RBZ | 94 | 1251 RBZ | 10 | 1431 SN | 66, 169 | 1701 BK | 168 |
| 1095 RBZ | 94 | 1253 RBZ | 10 | 1433 SN | 66 | 1701 BZ | 168 |
| 1099 RBZ | 94 | 1254 RBZ | 9 | 1435 SN | 66 | 1701 SN | 168 |
| 1101 VI | 46 | 1255 RBZ | 9 | 1436 SN | 65 | 1703 BZ | 112 |
| 1103 VI | 45 | 1259 RBZ | 7 | 1439 SN | 66 | 1703 SN | 112 |
| 1105 VI | 46 | 1261 RBZ | 9 | 1443 SN | 65 | 1703 WH | 111 |
| 1111 VI | 43 | 1263 RBZ | 7, 145 | 1453 SN | 65 | 1705 BZ | 112 |
| 1113 VI | 45 | 1282 RBZ | 128 | 1461 PW | 69, 162 | 1705 SN | 112 |
| 1116 VI | 43 | 1282 RS | 128 | 1462 PW | 70 | 1705 WH | 111 |
| 1121 VI | 43, 120 | 1283 RBZ | 128 | 1463 PW | 70 | 1711 BZ | 150 |
| 1122 VI | 46 | 1283 RS | 128 | 1465 PW | 70 | 1711 SN | 150 |
| 1123 VI | 44 | 1284 RBZ | 128 | 1469 PW | 69 | 1712-C/L | 174 |

INDEX

| <u>ITEM#</u> | <u>PAGE</u> | <u>ITEM#</u> | <u>PAGE</u> | <u>ITEM#</u> | <u>PAGE</u> | <u>ITEM#</u> | <u>PAGE</u> |
|--------------|-------------|--------------|-------------|--------------|-------------|--------------|-------------|
| 1713 BG | 111 | 2053 SN | 73 | 5093 BG | 148 | 5361 CH | 172, 232 |
| 1715 BG | 111 | 2055 SN | 74 | 5093 SM | 147 | 5361 CP | 172, 233 |
| 1721 BG | 168 | 2059 SN | 73 | 5095 BG | 148 | 5361 RBZ | 172, 230 |
| 1722-C/L | 174 | 2061 EB | 76 | 5095 SM | 147 | 5363 CH | 231 |
| 1725 SN | 108 | 2062 EB | 75 | 5121 EB | 152 | 5363 RBZ | 229 |
| 1731 BG | 150 | 2063 EB | 75 | 5123 EB | 152 | 5370 BN | 170, 234 |
| 1732 SN | 150 | 2065 EB | 76 | 5125 EB | 152 | 5370 RBZ | 170, 234 |
| 1735 EB | 108 | 2069 EB | 75 | 5131 SN | 152 | 5371 CH | 232 |
| 1741 SN | 167 | 2081 BG | 60, 162 | 5133 SN | 152 | 5371 CP | 233 |
| 1742-C/L | 174 | 2082 BG | 60 | 5135 SN | 152 | 5371 RBZ | 230 |
| 1744 SN | 107 | 2083 BG | 60 | 5161 RBZ | 153 | 5380 BN | 171, 236 |
| 1761 | 176 | 2085 BG | 59 | 5163 RBZ | 153 | 5380 RBZ | 171, 236 |
| 1762-C/L | 174 | 2089 BG | 59 | 5165 RBZ | 153 | 5381 CH | 171, 235 |
| 1771 | 176 | 2091 BG | 59 | 5171 VI | 154 | 5381 CP | 171, 235 |
| 1781 EB | 167 | 2093 BG | 60 | 5173 VI | 154 | 5381 RBZ | 171, 235 |
| 1784 EB | 107 | 2116 SN | 74 | 5175 VI | 154 | 5390 ABR | 218 |
| 1791 BG | 164 | 2216 EB | 76 | 5181 VI | 175 | 5390 GA | 218 |
| 1792-C/L | 174 | 3041 CH | 135 | 5191 VI | 175 | 5390 SB | 218 |
| 1795 BG | 108 | 3042 CH | 135 | 5201 RBZ | 148 | 5391 CP | 170, 234 |
| 1801 BG | 163 | 3043 CH | 135 | 5203 RBZ | 148 | 5391 RBZ | 170, 234 |
| 1802 EB | 150 | 3044 CH | 135 | 5205 RBZ | 148 | 5391 SN | 170, 234 |
| 1803 BG | 157 | 4012 CB | 142 | 5221 CH | 152 | 5401 RBZ | 153 |
| 1811 BG | 163 | 4013 CB | 142 | 5221 RBZ | 152 | 5401 RS | 154 |
| 1813 BG | 157 | 4014 CB | 142 | 5223 CH | 152 | 5403 RBZ | 153 |
| 1831 BG | 163 | 4082 RBZ | 140 | 5223 RBZ | 152 | 5403 RS | 154 |
| 1833 SN | 157 | 4083 RBZ | 140 | 5225 CH | 152 | 5405 RBZ | 153 |
| 1851 SN | 133 | 4085 RBZ | 140 | 5225 RBZ | 152 | 5405 RS | 154 |
| 1852 SN | 133 | 4086 RBZ | 140 | 5271 | 175 | 6002 BZ | 113 |
| 1853 SN | 133 | 5002 SN | 130 | 5281 RBZ | 175 | 6002 SN | 113 |
| 1854 SN | 133 | 5003 SN | 130 | 5291 RBZ | 175 | 6003 BZ | 113 |
| 1861 EB | 133 | 5004 SN | 130 | 5301 RBZ | 173, 225 | 6003 SN | 113 |
| 1862 EB | 133 | 5012 BG | 130 | 5301 SN | 173, 227 | 6016 BG | 79 |
| 1863 EB | 133 | 5013 BG | 130 | 5303 RBZ | 226 | 6053 BG | 82 |
| 1864 EB | 133 | 5014 BG | 130 | 5303 SN | 228 | 6063 BG | 81 |
| 1871 EB | 177 | 5021 KH | 176 | 5311 RBZ | 173, 226 | 6071 BG | 80 |
| 1881 SN | 177 | 5031 SN | 147 | 5311 SN | 173, 228 | 6073 BG | 79 |
| 1901 SN | 167 | 5033 SN | 147 | 5313 RBZ | 225 | 6075 BG | 80 |
| 1911 SN | 167 | 5034 RBZ | 151 | 5313 SN | 227 | 6079 BG | 80 |
| 1921 EB | 167 | 5035 SN | 147 | 5321 RBZ | 226 | 6092 SM | 142 |
| 1941 SN | 169 | 5041 BG | 156 | 5321 SN | 228 | 6093 SM | 142 |
| 1951 EB | 169 | 5042 BG | 156 | 5331 RBZ | 173, 222 | 6116 SN | 83 |
| 1961 SN | 163 | 5061 BG | 153 | 5331 SN | 173, 224 | 6163 SN | 84 |
| 1963-C/L | 174 | 5061 SM | 154 | 5333 RBZ | 222 | 6171 SN | 83 |
| 1981 EB | 163 | 5063 BG | 153 | 5333 SN | 224 | 6173 SN | 83 |
| 1991 EB | 163 | 5063 SM | 154 | 5341 RBZ | 221 | 6175 SN | 84 |
| 2001 BK | 56, 165 | 5065 BG | 153 | 5341 SN | 223 | 6179 SN | 84 |
| 2003 BK | 56 | 5065 SM | 154 | 5343 RBZ | 221 | 6501 RBZ | 51, 134 |
| 2006 BK | 55 | 5071 BG | 149 | 5343 SN | 223 | 6502 RBZ | 51, 134 |
| 2009 BK | 56 | 5073 BG | 149 | 5351 CH | 172, 231 | 6503 RBZ | 52 |
| 2012 BK | 55 | 5075 BG | 149 | 5351 CP | 172, 233 | 6513 RBZ | 51 |
| 2016 BK | 55 | 5083 BG | 114 | 5351 RBZ | 172, 229 | 6516 RBZ | 52 |
| 2051 SN | 74 | 5091 BG | 148 | 5353 CH | 232 | 6521 RBZ | 51, 169 |
| 2052 SN | 73 | 5091 SM | 147 | 5353 RBZ | 230 | 6523 RBZ | 51 |

| <u>ITEM#</u> | <u>PAGE</u> | <u>ITEM#</u> | <u>PAGE</u> | <u>ITEM#</u> | <u>PAGE</u> | <u>ITEM#</u> | <u>PAGE</u> |
|---------------------|-------------|----------------------|-------------|----------------------|-------------|---------------------|-------------|
| 6525 RBZ | 52 | 7162 BZ/G | 18 | G-133 | 178 | RES12-SG | 203 |
| 6529 RBZ | 51 | 7163 BZ/G | 17 | RAS10-ABR | 201 | RES12-SR | 203 |
| 6532 RBZ | 134 | 7165 BZ/G | 16 | RAS10-GA | 201 | RES12-WH | 203 |
| 6533 RBZ | 134 | 7169 BZ/G | 15 | RAS10-SB | 201 | RGN10-ABR | 181-206 |
| 6534 RBZ | 134 | 7171 BZ/G | 15, 125 | RAS10-SG | 201 | RGN10-CP | 181-190 |
| 7001 BG | 35 | 7173 BZ/G | 17 | RAS10-SR | 201 | RGN10-GA | 181-206 |
| 7003 BG | 31 | 7175 BZ/G | 16 | RAS10-WH | 201 | RGN10-SB | 181-206 |
| 7006 BG | 36 | 7183 BZ/G | 17 | RAS12-ABR | 199 | RGN10-SG | 181-206 |
| 7009 BG | 35 | 7191 RBZ | 123 | RAS12-GA | 199 | RGN10-SR | 181-206 |
| 7011 BG | 33, 166 | 7192 RBZ | 123 | RAS12-SB | 199 | RGN10-WH | 181-206 |
| 7013 BG | 36 | 7193 RBZ | 123 | RAS12-SG | 199 | RGN12-ABR | 181-206 |
| 7016 BG | 36 | 7194 RBZ | 123 | RAS12-SR | 199 | RGN12-CP | 181-190 |
| 7021 BG | 31 | 7201 RBZ | 53, 164 | RAS12-WH | 199 | RGN12-GA | 181-206 |
| 7022 BG | 32 | 7203 RBZ | 54 | RC-ABR | 208 | RGN12-SB | 181-206 |
| 7026 BG | 32 | 7205 RBZ | 53 | RC-CP | 208 | RGN12-SG | 181-206 |
| 7029 BG | 32 | 7209 RBZ | 53 | RC-GA | 208 | RGN12-SR | 181-206 |
| 7033 BG | 34 | 7211 RBZ | 54 | RC-SB | 208 | RGN12-WH | 181-206 |
| 7036 BG | 34 | 7213 RBZ | 54 | RC-SG | 208 | RGN15-ABR | 181-206 |
| 7038 BG | 34 | 7216 BB/S | 37 | RC-SR | 208 | RGN15-CP | 181-190 |
| 7044 BG | 33 | 7222 BG | 14 | RC-WH | 208 | RGN15-GA | 181-206 |
| 7046 BG | 33 | 7223 BG | 13 | RDBC10-ABR | 216 | RGN15-SB | 181-206 |
| 7052 BB/S | 132 | 7233 RBZ | 54 | RDBC10-GA | 216 | RGN15-SG | 181-206 |
| 7052 BG | 131 | 7251 SN | 63, 161 | RDBC10-SB | 216 | RGN15-SR | 181-206 |
| 7053 BB/S | 132 | 7253 SN | 64 | RDBC10-SG | 216 | RGN15-WH | 181-206 |
| 7053 BG | 131 | 7255 SN | 63 | RDBC10-SR | 216 | RGN22-ABR | 181-206 |
| 7054 BB/S | 132 | 7259 SN | 63 | RDBC10-WH | 216 | RGN22-CP | 181-190 |
| 7054 BG | 131 | 7261 SN | 64 | RDBC12-ABR | 215 | RGN22-GA | 181-206 |
| 7055 BB/S | 132 | 7263 SN | 64 | RDBC12-GA | 215 | RGN22-SB | 181-206 |
| 7055 BG | 131 | 7273 SN | 64 | RDBC12-SB | 215 | RGN22-SG | 181-206 |
| 7061 BB/S | 38, 164 | 7282 BZ/G | 125 | RDBC12-SG | 215 | RGN22-SR | 181-206 |
| 7063 BB/S | 38 | 7283 BZ/G | 125 | RDBC12-SR | 215 | RGN22-WH | 181-206 |
| 7065 BB/S | 37 | 7284 BZ/G | 125 | RDBC12-WH | 215 | RGN23-ABR | 181-206 |
| 7069 BB/S | 38 | 7301 AW/BZ | 1 | RDBS10-ABR | 197 | RGN23-CP | 181-190 |
| 7073 BB/S | 37 | 7302 AW/BZ | 3 | RDBS10-GA | 197 | RGN23-GA | 181-206 |
| 7082 BB/S | 38 | 7303 AW/BZ | 3 | RDBS10-SB | 197 | RGN23-SB | 181-206 |
| 7091 CH | 123 | 7305 AW/BZ | 2 | RDBS10-SG | 197 | RGN23-SG | 181-206 |
| 7092 CH | 123 | 7309 AW/BZ | 1 | RDBS10-SR | 197 | RGN23-SR | 181-206 |
| 7093 CH | 123 | 7313 AW/BZ | 2 | RDBS10-WH | 197 | RGN23-WH | 181-206 |
| 7094 CH | 123 | 7323 AW/BZ | 3 | RDBS12-ABR | 195 | RGN24-ABR | 181-206 |
| 7103 CH | 146 | 7812 BG | 50 | RDBS12-GA | 195 | RGN24-CP | 181-190 |
| 7113 RBZ | 146 | 9033 SN | 145 | RDBS12-SB | 195 | RGN24-GA | 181-206 |
| 7116 BG | 31 | 9092 BG | 106 | RDBS12-SG | 195 | RGN24-SB | 181-206 |
| 7121 BG | 13, 168 | 9093 BG | 106 | RDBS12-SR | 195 | RGN24-SG | 181-206 |
| 7122 BG | 14 | G-100 | 178 | RDBS12-WH | 195 | RGN24-SR | 181-206 |
| 7123 BG | 12 | G-101 | 178 | RES10-ABR | 205 | RGN24-WH | 181-206 |
| 7125 BG | 11 | G-110 | 178 | RES10-GA | 205 | RGN30-ABR | 181-206 |
| 7129 BG | 11 | G-121 | 178 | RES10-SB | 205 | RGN30-CP | 181-190 |
| 7131 BG | 12, 126 | G-124 | 178 | RES10-SG | 205 | RGN30-GA | 181-206 |
| 7133 BG | 14 | G-126 | 178 | RES10-SR | 205 | RGN30-SB | 181-206 |
| 7143 BG | 12 | G-129 | 178 | RES10-WH | 205 | RGN30-SG | 181-206 |
| 7152 BG | 126 | G-130 | 178 | RES12-ABR | 203 | RGN30-SR | 181-206 |
| 7153 BG | 126 | G-131 | 178 | RES12-GA | 203 | RGN30-WH | 181-206 |
| 7161 BZ/G | 18, 164 | G-132 | 178 | RES12-SB | 203 | RGN41-ABR | 181-206 |

INDEX

| <u>ITEM#</u> | <u>PAGE</u> | <u>ITEM#</u> | <u>PAGE</u> | <u>ITEM#</u> | <u>PAGE</u> | <u>ITEM#</u> | <u>PAGE</u> |
|----------------------|-------------|----------------------|-------------|----------------------|----------------------|----------------------|-------------|
| RGN41-CP | 181-190 | RRWC18-SB | 210 | RSCKSS-ABR | 208 | RWG17-SB | 191, 213 |
| RGN41-GA | 181-206 | RRWC18-SG | 210 | RSCKSS-CP | 208 | RWG17-SG | 191, 213 |
| RGN41-SB | 181-206 | RRWC18-SR | 210 | RSCKSS-GA | 208 | RWG17-SR | 191, 213 |
| RGN41-SG | 181-206 | RRWC18-WH | 210 | RSCKSS-SB | 208 | RWG17-WH | 191, 213 |
| RGN41-SR | 181-206 | RRWS12-ABR | 189 | RSCKSS-SG | 208 | RWHC14-ABR | 214 |
| RGN41-WH | 181-206 | RRWS12-CP | 189 | RSCKSS-SR | 208 | RWHC14-GA | 214 |
| RPAD-ABR | 207 | RRWS12-GA | 189 | RSCKSS-WH | 208 | RWHC14-SB | 214 |
| RPAD-CP | 207 | RRWS12-SB | 189 | RSCM-ABR | 181-198 | RWHC14-SG | 214 |
| RPAD-GA | 207 | RRWS12-SG | 189 | RSCM-CP | 181-190 | RWHC14-SR | 214 |
| RPAD-SB | 207 | RRWS12-SR | 189 | RSCM-GA | 181-198 | RWHC14-WH | 214 |
| RPAD-SG | 207 | RRWS12-WH | 189 | RSCM-SB | 181-198 | RWHC17-ABR | 213 |
| RPAD-SR | 207 | RRWS15-ABR | 187 | RSCM-SG | 181-198 | RWHC17-GA | 213 |
| RPAD-WH | 207 | RRWS15-CP | 187 | RSCM-SR | 181-198 | RWHC17-SB | 213 |
| RPAS-ABR | 207 | RRWS15-GA | 187 | RSCM-WH | 181-198 | RWHC17-SG | 213 |
| RPAS-CP | 207 | RRWS15-SB | 187 | RSW-ABR | 208 | RWHC17-SR | 213 |
| RPAS-GA | 207 | RRWS15-SG | 187 | RSW-CP | 208 | RWHC17-WH | 213 |
| RPAS-SB | 207 | RRWS15-SR | 187 | RSW-GA | 208 | RWHS14-ABR | 193 |
| RPAS-SG | 207 | RRWS15-WH | 187 | RSW-SB | 208 | RWHS14-GA | 193 |
| RPAS-SR | 207 | RRWS18-ABR | 185 | RSW-SG | 208 | RWHS14-SB | 193 |
| RPAS-WH | 207 | RRWS18-CP | 185 | RSW-SR | 208 | RWHS14-SG | 193 |
| RRRC14-ABR | 209 | RRWS18-GA | 185 | RSW-WH | 208 | RWHS14-SR | 193 |
| RRRC14-CP | 209 | RRWS18-SB | 185 | RWG10-ABR | 197, 201 205, 216 | RWHS14-WH | 193 |
| RRRC14-GA | 209 | RRWS18-SG | 185 | RWG10-GA | 197, 201 205, 216 | RWHS17-ABR | 191 |
| RRRC14-SB | 209 | RRWS18-SR | 185 | RWG10-SB | 197, 201 205, 216 | RWHS17-GA | 191 |
| RRRC18-ABR | 209 | RRWS18-WH | 185 | RWG10-SG | 197, 201 205, 216 | RWHS17-SB | 191 |
| RRRC18-CP | 209 | RS1-ABR | 181-198 | RWG10-SR | 197, 201 205, 216 | RWHS17-SG | 191 |
| RRRC18-GA | 209 | RS1-CP | 181-190 | RWG10-WH | 197, 201 205, 216 | RWHS17-SR | 191 |
| RRRC18-SB | 209 | RS1-GA | 181-198 | RWG12-ABR | 195, 199 203, 215 | RWHS17-WH | 191 |
| RRRS14-ABR | 183 | RS1-SB | 181-198 | RWG12-GA | 195, 199 203, 215 | RWHWB8-ABR | 217 |
| RRRS14-CP | 183 | RS1-SG | 181-198 | RWG12-SB | 195, 199 203, 215 | RWHWB8-GA | 217 |
| RRRS14-GA | 183 | RS1-SR | 181-198 | RWG12-SG | 195, 199 203, 215 | RWHWB8-SB | 217 |
| RRRS14-SB | 183 | RS1-WH | 181-198 | RWG12-SR | 195, 199 203, 215 | RWHWB8-SG | 217 |
| RRRS18-ABR | 181 | RS2-ABR | 181-198 | RWG12-WH | 195, 199 203, 215 | RWHWB8-SR | 217 |
| RRRS18-CP | 181 | RS2-CP | 181-190 | RWG14-ABR | 193, 214 | RWHWB8-WH | 217 |
| RRRS18-GA | 181 | RS2-GA | 181-198 | RWG14-GA | 193, 214 | S-7 | 178 |
| RRRS18-SB | 181 | RS2-SB | 181-198 | RWG14-SB | 193, 214 | S-8 | 178 |
| RRWC12-ABR | 212 | RS2-SG | 181-198 | RWG14-SG | 193, 214 | | |
| RRWC12-CP | 212 | RS2-SR | 181-198 | RWG14-SR | 193, 214 | | |
| RRWC12-GA | 212 | RS2-WH | 181-198 | RWG14-WH | 193, 214 | | |
| RRWC12-SB | 212 | RS3-ABR | 181-198 | RWG17-ABR | 191, 213 | | |
| RRWC12-SG | 212 | RS3-CP | 181-190 | RWG17-GA | 191, 213 | | |
| RRWC12-SR | 212 | RS3-GA | 181-198 | | | | |
| RRWC12-WH | 212 | RS3-SB | 181-198 | | | | |
| RRWC15-ABR | 211 | RS3-SG | 181-198 | | | | |
| RRWC15-CP | 211 | RS3-SR | 181-198 | | | | |
| RRWC15-GA | 211 | RS3-WH | 181-198 | | | | |
| RRWC15-SB | 211 | RSCK-ABR | 181-198 | | | | |
| RRWC15-SG | 211 | RSCK-CP | 181-190 | | | | |
| RRWC15-SR | 211 | RSCK-GA | 181-198 | | | | |
| RRWC15-WH | 211 | RSCK-SB | 181-198 | | | | |
| RRWC18-ABR | 210 | RSCK-SG | 181-198 | | | | |
| RRWC18-CP | 210 | RSCK-SR | 181-198 | | | | |
| RRWC18-GA | 210 | RSCK-WH | 181-198 | | | | |

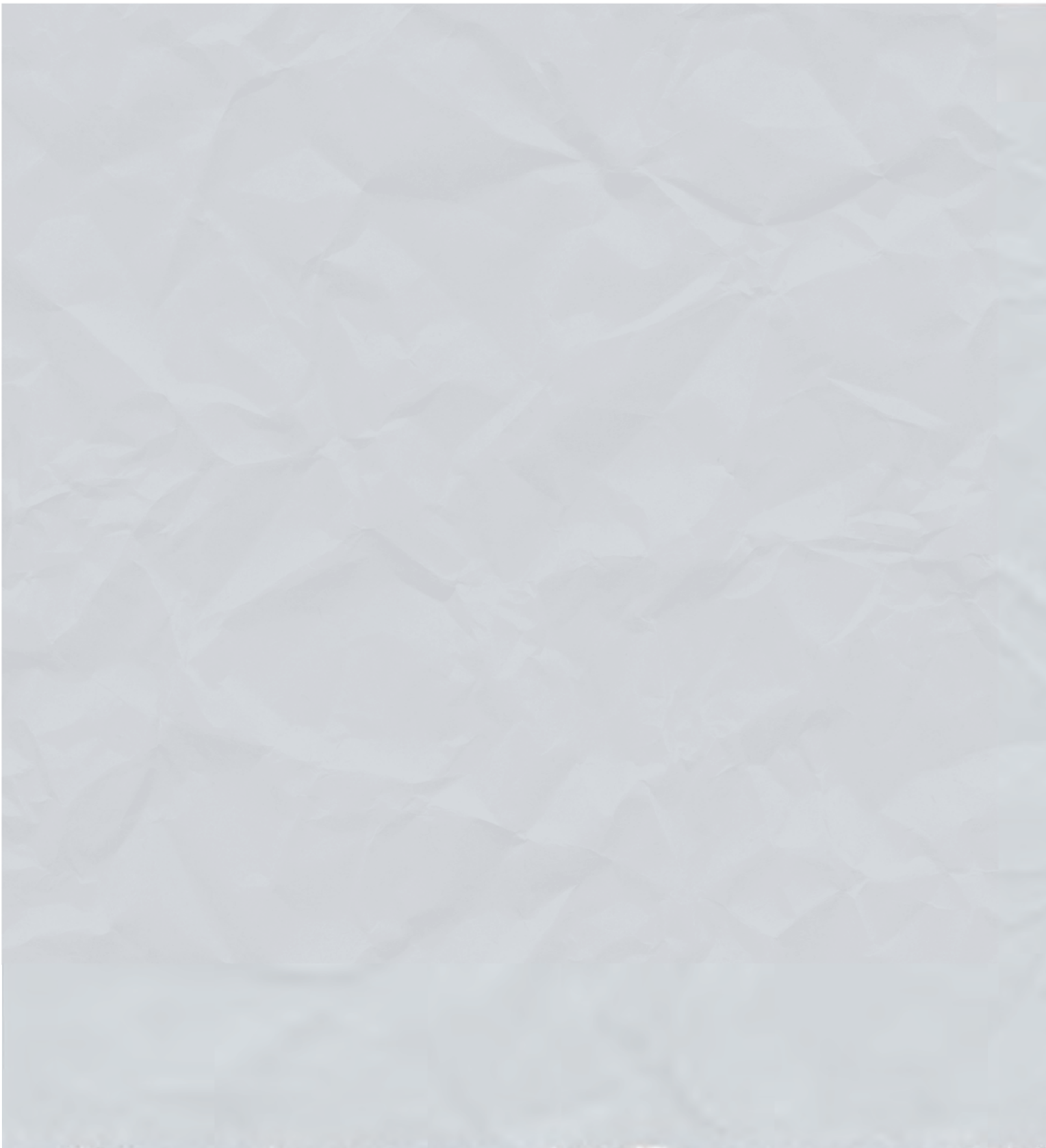

Millennium Lighting, Inc.

922 Dailey Mill Road
McDonough, GA 30253

Phone: 678-432-6190
Toll Free: 866-432-6190

Fax: 678-432-6196
Toll Free Fax: 877-851-2294



Millennium Lighting reserves the right to make
any price and/or product changes.