

**BATH HANDLE TRIM  
K-T13141**

**Features**

- Metal construction
- Bath- or deck-mount
- Available with cross or lever handles

**Codes/Standards Applicable**

Specified model meets or exceeds the following:

- ASME A112.18.1
- CSA B125
- ADA



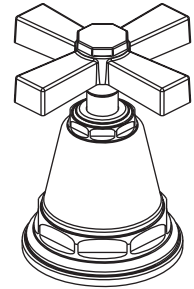
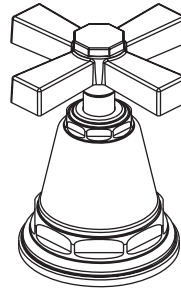

ADA



**Colors/Finishes**

- CP: Polished Chrome
- Other: Refer to Price Book for additional colors/finishes

**Specified Model**

Model	Description	 ADA	 ADA	 ADA	 ADA
K-T13141-3A	Bath valve trim with plain cross handles without spout	<input type="checkbox"/> CP <input type="checkbox"/> Other			
K-T13141-3B	Bath valve trim with grooved cross handles without spout		<input type="checkbox"/> CP <input type="checkbox"/> Other		
K-T13141-4A	Bath valve trim with plain lever handles without spout			<input type="checkbox"/> CP <input type="checkbox"/> Other	
K-T13141-4B	Bath valve trim with grooved lever handles, without spout				<input type="checkbox"/> CP <input type="checkbox"/> Other

**Product Specification**

Two-handle deck- or bath-mount high-flow bath faucet trim shall be of metal construction. Trim shall include faucet handles. Faucet trim shall be Kohler Model K-T13141-\_\_\_\_-\_\_\_\_ and valve system shall be Kohler Model K-\_\_\_\_-K\_\_\_\_-NA.

# PINSTRIPETM

## Required Accessory

K-300-K	1/2" High-flow valve system
K-300-KR	1/2" High-flow valve system, rigid connections
K-301-K	3/4" High-flow valve system
K-302-K	1/2" Wall-mount valve system

## Technical Information

Mexico faucets and fittings have an **M** after the first sequence of numbers (such as K-12345 **M**).

Applicable faucet trim:

Bath valve trim with plain cross handles	K-T13141-3A
Bath valve trim with grooved cross handles	K-T13141-3B
Bath valve trim with plain lever handles	K-T13141-4A
Bath valve trim with grooved lever handles	K-T13141-4B

Applicable valve\*:

1/2" valve system	K-300-K
1/2" valve system with rigid connections	K-300-KR
3/4" valve system	K-301-K
1/2" wall-mount ceramic disc valve system	K-302-K
* Required for operation (not shown).	
Handles are ADA compliant <span style="border: 1px solid black; padding: 2px;">ADA</span>	

## Installation Notes

Install this product according to the installation guide.

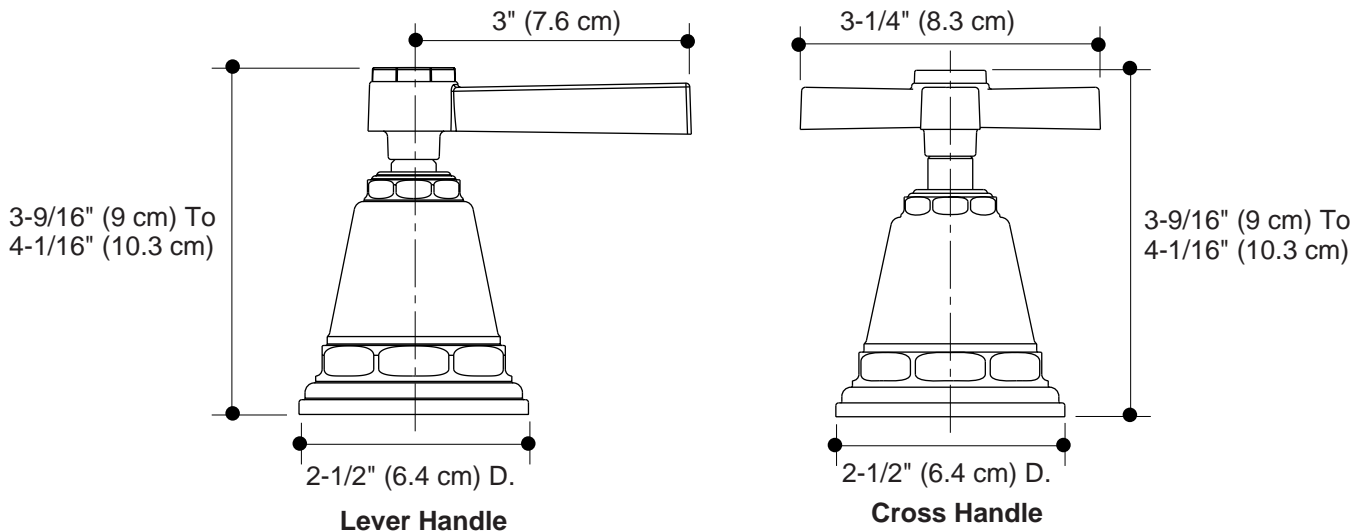

## Product Diagram