

Features

- CleanCoat® technology creates a barrier between the water and glass to help keep your shower door looking new.
- Frameless design highlights showering area.
- Frameless, 1/4" (6 mm) thick Falling Lines tempered glass.
- Continuous guide mechanism for smooth, quiet sliding action and easy cleaning.
- Gently curved towel bars inside and out complete the look of this door.

Material

- Anodized aluminum prevents rusting or corrosion.
- Tempered glass ensures maximum safety and durability.

Installation

- Out-of-plumb adjustability allows for simpler installation.
- Can be installed to open to the left or right.

Components

Additional included component/s: Hardware kit.



Codes/Standards



CPSC 16CFR 1201
ANSI Z97.1 (Tempered Glass)

KOHLER® One-Year Limited Warranty

See website for detailed warranty information.

Available Color/Finishes

Color tiles intended for reference only.

Color	Code	Description
	SHP	Bright Polished Silver
	MX	Matte Nickel
	ABV	Anodized Brushed Bronze

Available Glass Options

Code	Description
G54	Falling Lines

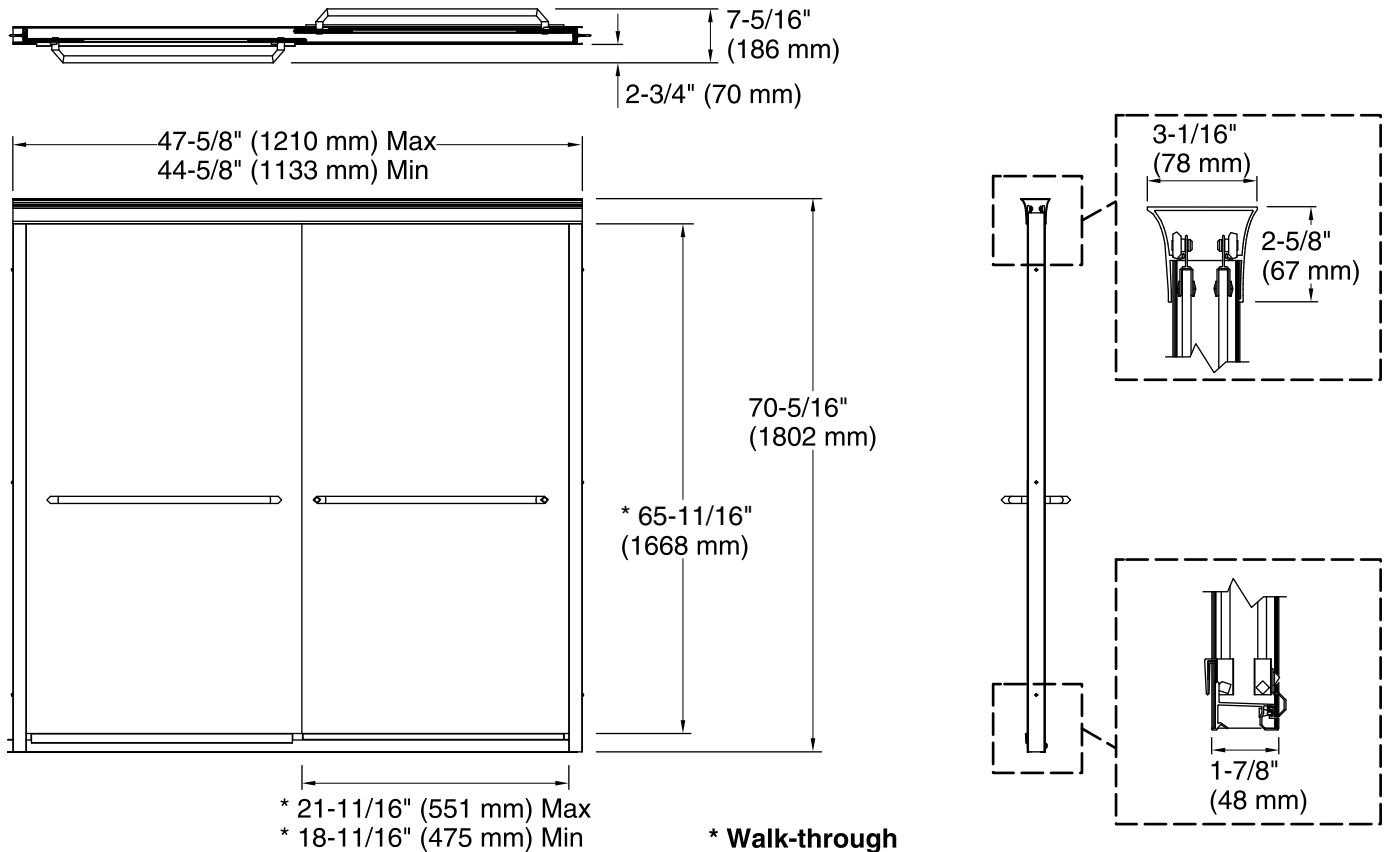

Technical Information

All product dimensions are nominal.

Installation type:	For shower base installation
Opening style:	Sliding/Bypass
Opening Width - Min:	44-5/8" (1133 mm)
Opening Width - Max:	47-5/8" (1210 mm)
Walk-through - Min:	18-11/16" (475 mm)
Walk-through - Max:	21-11/16" (551 mm)
Glass thickness:	1/4" (6 mm)
Glass coating:	CleanCoat®

Notes

Install this product according to the installation guide.

The vertical opening should be a minimum of 72-1/16" (1830 mm) to allow for installation clearance.