

Features

- Brass construction
- Bath- or deck-mount
- Variety of handle style options
- 5" (12.7 cm) spout with slip-fit connection and diverter knob

Codes/Standards Applicable

Specified model meets or exceeds the following:

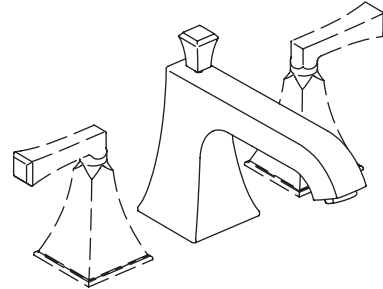

- ASME A112.18.1
- IAPMO/UPC
- CSA B125
- ADA





Colors/Finishes

- CP: Polished Chrome
- Other: Refer to Price Book for additional colors/finishes

Specified Model

Model	Description	 ADA	 ADA
K-T428-3C	Faucet with classic cross handles	<input type="checkbox"/> CP <input type="checkbox"/> Other _____	
K-T428-4C	Faucet with classic lever handles		<input type="checkbox"/> CP <input type="checkbox"/> Other _____

Model	Description	 ADA	 ADA	 ADA
K-T428-3S	With stately cross handles	<input type="checkbox"/> CP <input type="checkbox"/> Other _____		
K-T428-4S	With stately faceted lever handles		<input type="checkbox"/> CP <input type="checkbox"/> Other _____	
K-T428-4V	With stately deco lever handles			<input type="checkbox"/> CP <input type="checkbox"/> Other _____

Product Specification

Two-handle bath- or deck-mount bath faucet trim shall be of brass construction. Product shall install to bath or finished deck. Product shall include a 5" (12.7 cm) spout with slip-fit connection and diverter knob. Product shall have a variety of handles. Faucet trim shall be Kohler Model K-T428-_____-_____-_____- and valve system shall be Kohler Model K-438-K-NA.

MEMOIRS®

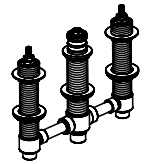

Required Accessory

K-438-K	1/2" High-flow ceramic disc valve system with integral diverter	<input type="checkbox"/> NA
---------	---	-----------------------------

Optional Accessory

K-419	Handshower	<input type="checkbox"/> CP	<input type="checkbox"/> Other _____
K-424	Deck handshower holder	<input type="checkbox"/> CP	<input type="checkbox"/> Other _____

Colors/Finishes

Installation Notes

Install this product according to the installation guide.

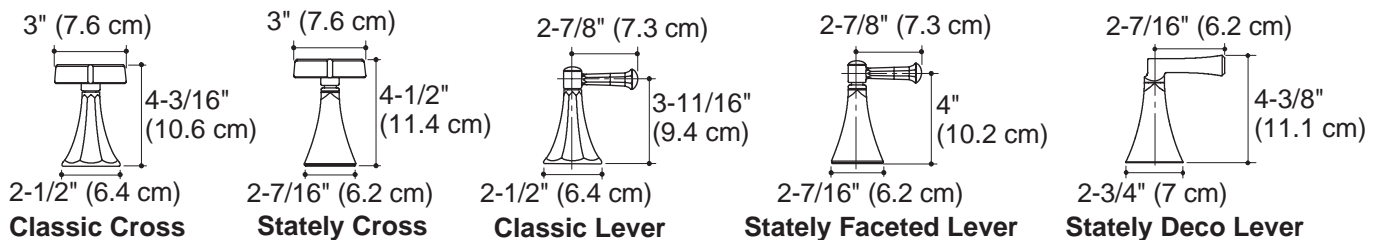
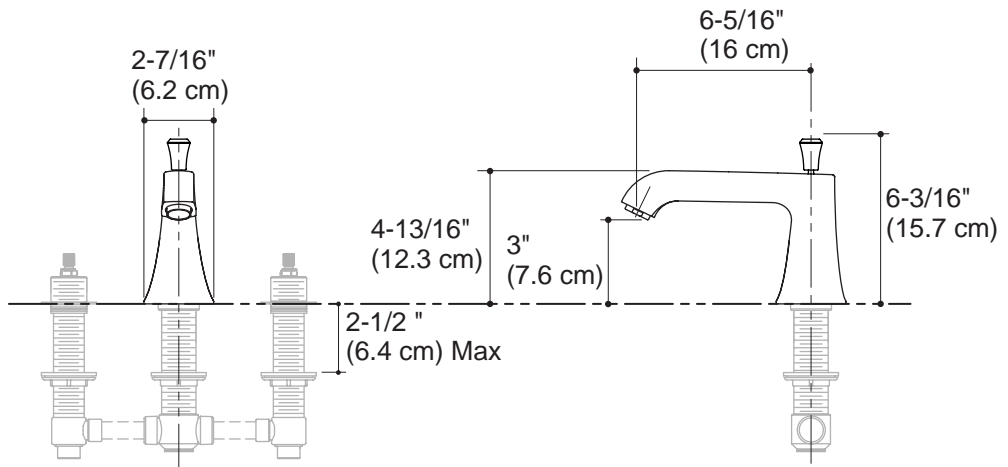

Product Diagram