

### Features

- One-piece toilets integrate the tank and bowl into a seamless, easy-to-clean design.
- Elongated bowl offers added room and comfort.
- Comfort Height® feature offers chair-height seating that makes sitting down and standing up easier for most adults.
- 1.0 gallon per flush (gpf).
- Equipped with Sloan Flushmate® Pressure Vessel.
- Seat and lid included.
- Supply line not included.

### Technology

- Pressure Lite® flushing technology provides commercial-grade flushing power while reducing water use.

### Installation

- Standard 12-inch rough-in.

### Recommended Accessories

K-7637 Angle Supply with Stop (single)

### Optional Accessories

K-4650 Toilet Seat

### Components

Additional included component/s: Tank Cover, Bolt Cap Accessory Pack, Toilet Seat, and Tank Accessory Pack.



OBC

### Codes/Standards

ASME A112.19.2/CSA B45.1

EPA WaterSense®

California Energy Commission (CEC)









OBC

### Kohler One-Year Limited Warranty

See website for detailed warranty information.

### Available Color/Finishes

*Color tiles intended for reference only.*

Color	Code	Description
	0	White
	96	Biscuit
	47	Almond
	NY	Dune
	95	Ice™ Grey
	G9	Sandbar
	58	Thunder™ Grey
	7	Black Black™

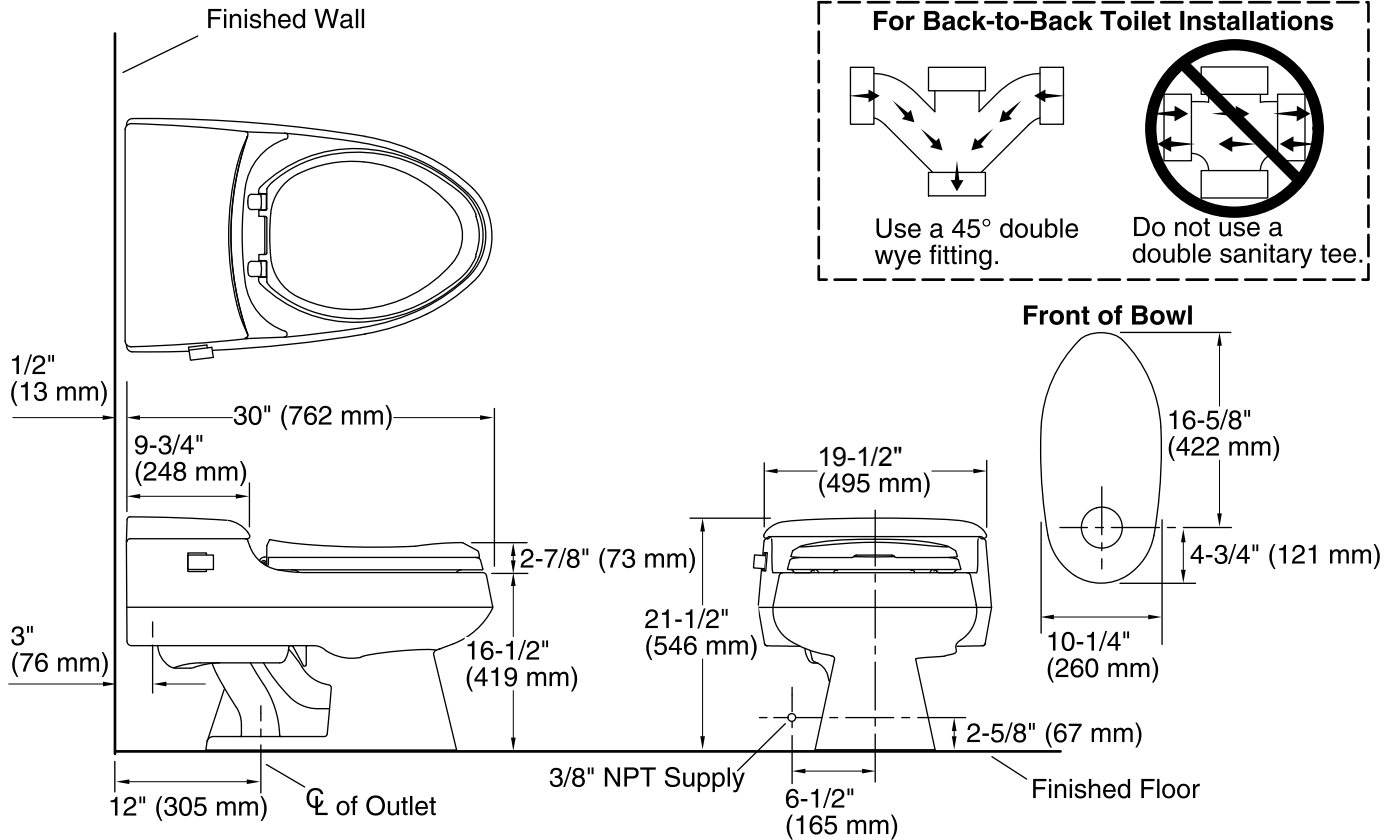

### Technical Information

All product dimensions are nominal.

Toilet type:	One-piece
Bowl shape:	Elongated front
Trap passageway:	2-1/8" (54 mm)
Water Consumption	
Full:	1 gpf (3.8 lpf)
Water surface size:	9" x 7" (229 mm x 178 mm)
Rim to water surface:	5-7/8" (149 mm)
Rough-in:	12" (305 mm)
Seat-mounting holes:	5-1/2" (140 mm)

### Fixture Supply Requirements

Min static pressure: 35 psi (241.3 kPa)

### Notes

Install this product according to the installation instructions.

For back-to-back toilet installations: Use only a 45° double wye fitting.

OBC compliant when installed to the specific requirements of these regulations.

The Model Plumbing Codes require the installation of elongated open-front toilet seats on public bathrooms.