



Underscore® Rectangle

5.5' BubbleMassage™ Bath

K-1173-G



Features

- End drain.
- Slotted overflow for deep soaking.
- Integral lumbar support.
- 66" (1676 mm) x 36" (914 mm) x 22" (559 mm)

Material

- Acrylic

Hydrotherapy

- 122 BubbleMassage™ airjets. 18 levels of massage intensity.
- Zones of Control feature allows you to target massage to back, midsection, or feet.
- Automatic purge cycles remove residual water from air channels after use.
- Built-in 300 W heater.
- Lighted keypad control.

Installation

- Drop-in or under-mount.

Required Accessories

K-7271 Brass Slotted Overflow Bath Drain

or

K-7272 PVC Slotted Overflow Bath Drain

Recommended Accessories

K-1491 Bath/Whirlpool Pillow

K-1601 Bath/Whirlpool Footstop

K-1705 Whirlpool/BubbleMassage™ Remote Control

K-591 Under-mount Installation Kit

K-9498 3" Keypad Trim

K-24916 Wireless Music Kit

K-1177 Vinyl Tiling-in Bead



Codes/Standards

ASME A112.19.7/CSA B45.10

ASTM E162

ASTM E662











Greenguard UL 2818 - Gold

KOHLER® One-Year Limited Warranty

See website for detailed warranty information.

Available Color/Finishes

Color tiles intended for reference only.

Color	Code	Description
	0	White
	96	Biscuit
	47	Almond
	NY	Dune
	95	Ice™ Grey
	G9	Sandbar
	33	Mexican Sand™
	K4	Cashmere
	58	Thunder™ Grey
	7	Black Black™

USA/Canada: 1-800-4KOHLER (1-800-456-4537)

Kohler Co. reserves the right to make revisions without notice to product specifications.

For the most current Specification Sheet, go to www.kohler.com.

2-12-2018 02:46

THE BOLD LOOK
OF **KOHLER**®

No change in measurements if connected with drain illustrated. (K-7272)

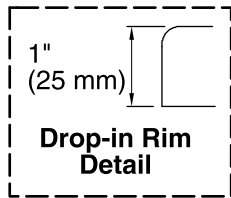

Blower Motor/Control Access
34" (864 mm) W x 15" (381 mm) H Min

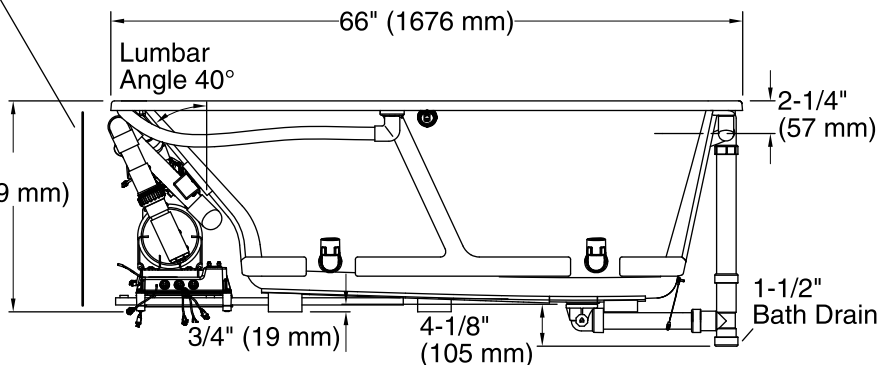
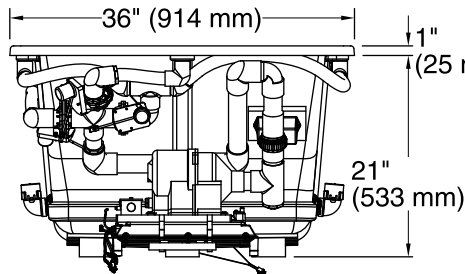
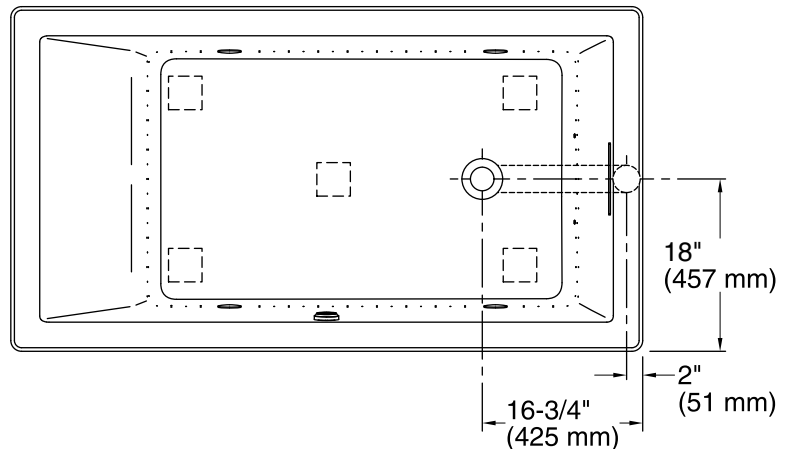

Required Electrical Service

One dedicated circuit required, protected with Class A Ground-Fault Circuit-Interrupter (GFCI) or Residual Current Device (RCD).

Blower: 240 V, 15 A, 50/60 Hz

Technical Information

All product dimensions are nominal.

Installation:	Drop-in, Under-mount
Drain location:	End
Basin area, bottom:	44-1/2" x 26-1/2" (1130 mm x 673 mm)
Basin area, top:	60-1/4" x 30-1/4" (1530 mm x 768 mm)
Weight:	105 lbs (47.6 kg)
Minimum floor load:	60 lbs/ft ² (292.9 kg/m ²)
Water depth:	17-3/4" (451 mm)
Water capacity:	102 gal (386.1 L)
Cutout:	Drop-in, 65" x 35" (1651 mm x 889 mm)
Electrical component rating:	Blower: 240 V, 5 A, 50/60 Hz
Blower speed:	Variable
Minimum flat for door:	2-7/16" (61 mm)

Notes

Measure your actual product for rough-in details.

Install this product according to the installation instructions.

The hot water supply should be 70% of the capacity of the bath or greater. Installations will vary.

Kit is required for under-mount installations (sold separately).

If relocating the blower motor, do not relocate or alter the PVC tee or coiled flexible tubing connected to the blower. Follow the blower relocation instructions exactly. Provide access for servicing the blower.