

Features

- One-piece toilets integrate the tank and bowl into a seamless, easy-to-clean design.
- Elongated bowl offers added room and comfort.
- 1.28 gallons per flush (gpf).
- 2-1/8-inch glazed trapway.
- Standard left-hand Polished Chrome trip lever included.
- Cachet® Quiet-Close™ seat with Quick-Release™ functionality allows seat to close quietly and quickly unlatch from the toilet for easy removal and convenient cleaning.
- Supply line not included.
- Coordinates with other products in the Archer collection.

Technology

- Single-flush gravity uses the force of gravity and a precision-engineered tank, bowl, and trapway to create a strong siphon during flushing.
- Class Five® flushing technology offers plug- and leak-free performance, extraordinary flushing, and better rinsing power for a cleaner bowl.

Installation

- Standard 12-inch rough-in.

Water Conservation & Rebates

- WaterSense® toilets meet strict EPA flushing guidelines, including using at least 20 percent less water than 1.6-gallon toilets.
- Eligible for consumer rebates in some municipalities.

Recommended Accessories

K-7637 Angle Supply with Stop (single)

Optional Accessories

K-11069 Trip Lever

Components

Additional included component/s: Tank Cover, Trip Lever, Left Hand, Toilet Seat, Tank Accessory Pack, and Bolt Cap Accessory Pack.



Codes/Standards











ASME A112.19.2/CSA B45.1
DOE - Energy Policy Act 1992
EPA WaterSense®

KOHLER® One-Year Limited Warranty

See website for detailed warranty information.

Available Color/Finishes

Color tiles intended for reference only.

Color	Code	Description
	0	White
	96	Biscuit
	47	Almond
	NY	Dune
	95	Ice™ Grey
	G9	Sandbar
	33	Mexican Sand™
	K4	Cashmere
	58	Thunder™ Grey
	7	Black Black™

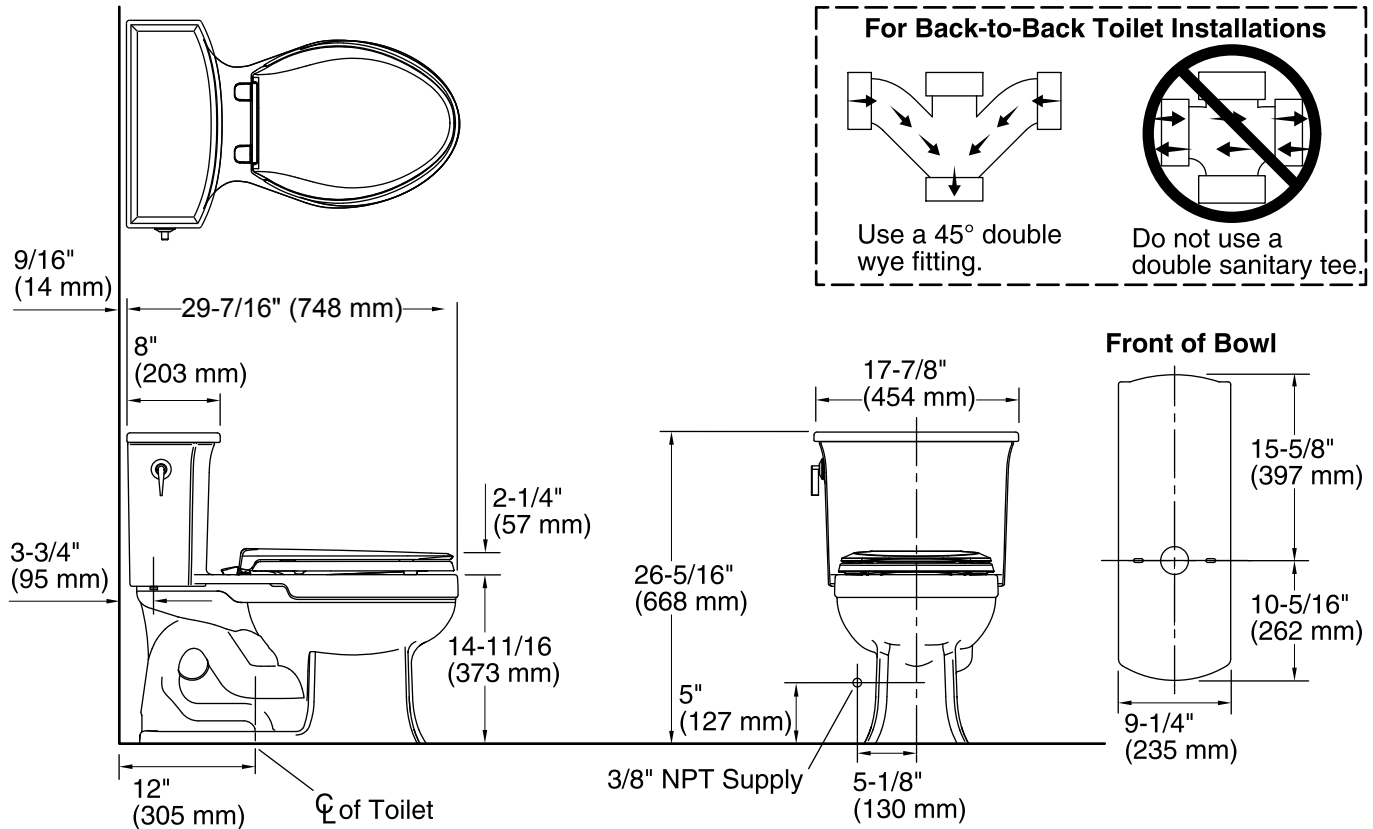

Technical Information

All product dimensions are nominal.

Toilet type: One-piece

Bowl shape: Elongated front

Trap passageway: 2-1/8" (54 mm)

Water Consumption

Full: 1.28 gpf (4.8 lpf)

Water surface size: 11-1/2" x 8-1/4" (292 mm x 210 mm)

Rim to water surface: 5" (127 mm)

Rough-in: 12" (305 mm)

Seat-mounting holes: 5-1/2" (140 mm)

Notes

Install this product according to the installation instructions.

For back-to-back toilet installations: Use only a 45° double wye fitting.