

SEASHORE 7707 SERIES

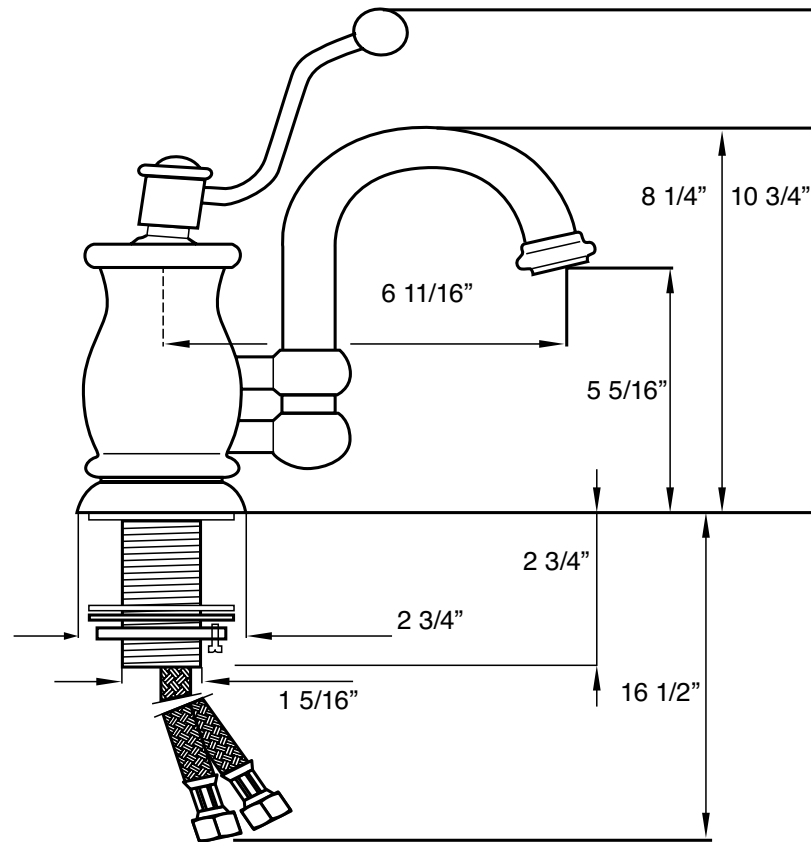

- SOLID BRASS CONSTRUCTION
- CERAMIC DISC CARTRIDGE
- STAINLESS INLET HOSES



TELEPHONE: 312-243-0770 • FAX: 312-243-1661 • TOLL-FREE: 888-301-8787 • WWW.MICODESIGNS.COM

Thank you for purchasing a product from



We have taken care to produce a product that will provide many years of trouble-free use and beauty. Call Toll Free: 1-888-301-8787 if you have any questions about the installation of your product. We can help!

1. Familiarize yourself with all of the parts before installation.
2. Turn off the water supply. Make sure both the hot and cold water are completely shut off.
3. **If you have a product (without side spray):**

Attach the stainless steel connectors and the supply tubes to the spout. Tighten. Screw in the threaded rod. Position the faucet throughout the sink hole with the base plate and black O-ring between the spout and the deck top. From the underside attach the gasket and mounting plate. Properly position the faucet. Tighten the hex nut onto the mounting rod.

If you have a product (with side spray)

Mount faucet through the sink hole with base ring

between the faucet and the deck top. Place the rubber gasket and the flat ring underneath the countertop and tighten.

Mount side spray the same as the faucet.

Connect the backflow fitting to the supply tube with the washer in between. Connect the side spray hose to the backflow preventer with the washer in between.

4. Connect the hot and cold water supplies. Red to hot, blue to cold.

5. Open water supplies and check for leaks.

Remove the aerator and run both the hot and cold water to flush out particles. Replace the aerator

Maintenance and Care: Clean with water and a soft cloth. Never use cleansers. Never use any abrasives.
THIS FAUCET IS NOT TO BE CONNECTED TO PORTABLE APPLIANCE