



Design features:

- Formed from high-grade thermoplastic
- Ideal for new or remodel projects...fits DURABASE® Shower Floors (see Accessories section) as well as bases from other manufacturers.
- Fits alcoves up to 48" wide by 42" deep
- Includes six large, molded-in, self-draining shelves ideal for shampoo, soap, etc.
- Panels can be trimmed to simplify installation in out-of-plumb alcoves
- Five panel wall system with seamless corner panels and overlapping edges, create a watertight wall surround.
- Adhesive mounts to drywall or like surfaces
- Available in white
- Smooth, colorfast glossy finish, resists scuffs.
- Mold and mildew-resistant...easy to clean
- Available STYLEMATE® shower enclosures feature tempered safety glass and a range of finishes (see Accessories section).

Specifications

Model	Color	Fits Alcoves	Shelves	UPC
247WHT	White	Width to 48", depth to 42"	6	6 71031 00048 4

General: Furnish and install as shown on plans, DURAWALL® Shower Walls Model 247 as manufactured by E.L. Mustee & Sons, Inc. Thermoplastic wall system shall be 5-piece construction with six formed shelves and overlapping corner panels. Uniform color throughout entire thickness of each panel. Color: White. Carton Contains: Center Panel, two end panels, two corner panels and instructions. Carton is 36-1/2"x73"x6", Weight 32 lbs.

Requires five or more 11 oz. cartridges of panel adhesive labeled for bonding to Bathtub and Shower walls.

Don't use adhesive containing tar, asphalt, lacquer thinner or toluene.

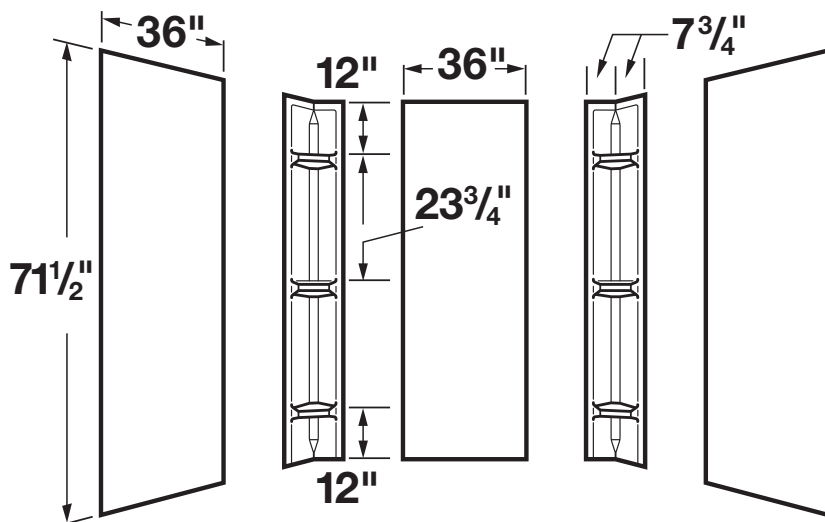



MUSTEE

Preferred by the "Pros"

247 DURAWALL® Thermoplastic Shower Walls, Square & Rectangular Showers

MORE ON PAGE 3 ▶

▶ DURABASE® Fiberglass Square & Rectangular Shower Floors

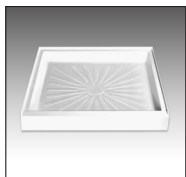

Mustee offers numerous DURABASE® square and rectangular shower floors in white for the 247 DURAWALL® Shower wall, which can fit alcoves up to 48" wide and 42" deep.

▶ CareGiver® Grab Bars

Straight 304 stainless steel grab bars provide in-shower support and stability.

1½" DIA. INSIDE CORNER STYLES

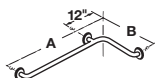

Model	A	– Size –	B	C	UPC
390.304	34"		18"	90°	6 71031 00362 1

1½" DIA. STRAIGHT



Model	Size	UPC
390.305	18"	6 71031 00452 9
390.301	24"	6 71031 00359 1
390.306	36"	6 71031 00434 5
390.307	42"	6 71031 00435 2

1½" DIA. ANGLED

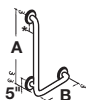

Model	A	– Size –	B	C	UPC
390.308	24"		16"	90°	6 71031 00436 9
390.309	32"		16"	90°	6 71031 00437 6

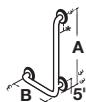

390.310	24"		16"	90°	6 71031 00438 3
390.311	32"		16"	90°	6 71031 00439 0

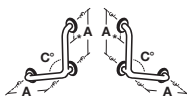

390.312	30"			90°	6 71031 00440 6
390.313	12"		No Corner Flange	120°	6 71031 00441 3

390.314	16"			120°	6 71031 00442 0
---------	-----	--	--	------	-----------------

Rotate for RH or LH use

390.315	24"			120°	6 71031 00443 7
---------	-----	--	--	------	-----------------



MUSTEE

E.L. Mustee & Sons, Inc. • 5431 West 164th Street • Brook Park, OH 44142 • Phone: 216.267.3100 • Fax: 216.267.9997
E-mail: info@mustee.com • Web: www.mustee.com • Proudly made in the USA

Notice: Our continuous commitment to product improvement may result in changes to product specifications without notice. Patents pending. Made and Printed in U.S.A.



MUSTEE

Preferred by the "Pros"

247 DURAWALL® Thermoplastic Shower Walls, Square & Rectangular Showers

► CareGiver® Fold-Down Shower Seats

CareGiver® Fold-Down Shower Seats can be ordered in Right hand, Left hand and Rectangular Fold-Down and Leg-supported styles. All popular sizes are available to provide a stable, secure place to sit while showering.



Model	Size	UPC
390.402	26" x 21"	6 71031 00364 5
390.404	32" x 21"	6 71031 00366 9



Model	Size	UPC
390.401	26" x 21"	6 71031 00363 8
390.403	32" x 21"	6 71031 00365 2



Model	Size	UPC
390.405	26" x 21"	6 71031 00444 4
390.406	32" x 21"	6 71031 00445 1



Model	Size	UPC
390.407	26" x 21"	6 71031 00446 8
390.408	32" x 21"	6 71031 00447 5

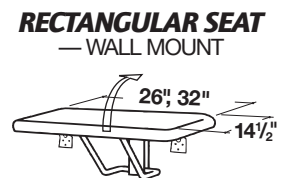

Model	Size	UPC
390.409	26" x 14 1/2"	6 71031 00448 2
390.410	32" x 14 1/2"	6 71031 00449 9



Model	Size	UPC
390.411	26" x 14 1/2"	6 71031 00450 5
390.412	32" x 14 1/2"	6 71031 00451 2

► Enclosures, Pivot and Bypass Doors

Premium quality STYLEMATE® enclosures available for the 247 DURAWALL® shower walls include...

STYLEMATE® — PIVOT DOOR ENCLOSURES



Model No.	Finish	Glass	Height	Opening	UPC
32.705	Chrome	Clear	65"	29" - 31"	6 71031 00462 8
32.706	Oil Rubbed Bronze	Clear	65"	29" - 31"	6 71031 00463 5
36.403	Chrome	Clear	65"	34" - 35-1/2"	6 71031 00464 2
36.404	Oil Rubbed Bronze	Clear	65"	34" - 35-1/2"	6 71031 00465 9

STYLEMATE® — BY-PASS FRAMED AND BY-PASS FRAMELESS ENCLOSURES

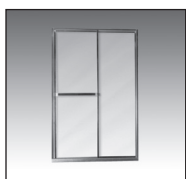

Model No.	Finish	Glass	Height	Opening	UPC
Framed Design					
48.403	Chrome	Clear	69"	47"	6 71031 00466 6
48.404	Brushed Nickel	Clear	69"	47"	6 71031 00467 3
48.405	Oil-Rubbed Bronze	Clear	69"	47"	6 71031 00468 0
Frameless Design					
48.406	Chrome	Clear	69"	47"	6 71031 00469 7
48.407	Brushed Nickel	Clear	69"	47"	6 71031 00470 3
48.408	Oil-Rubbed Bronze	Clear	69"	47"	6 71031 00471 0



MUSTEE

E.L. Mustee & Sons, Inc. • 5431 West 164th Street • Brook Park, OH 44142 • Phone: 216.267.3100 • Fax: 216.267.9997
E-mail: info@mustee.com • Web: www.mustee.com • Proudly made in the USA

Notice: Our continuous commitment to product improvement may result in changes to product specifications without notice. Patents pending. Made and Printed in U.S.A.