



MUSTEE

Preferred by the "Pros"

760T-34WHT DURAWALL® Fiberglass Shower Walls for Rectangular Showers, 34" x 60"

SEE PAGES 2-3 FOR A LIST OF ACCESSORIES! ▶



The 760T-34WHT shown above includes optional 3460M DURABASE® Shower Floor and 60.407 STYLEMATE® Brushed Nickel enclosure.



572.300 VARISTONE® Shelf (order separately) These self-draining 12" x 7" color-matched shelves, easily mount to the 760T-34WHT shower wall at any location. Order multiple shelves to best meet your personal preference.

Design features:

- Produced from high-grade, reinforced, molded fiberglass for optimum strength and impact resistance using matched metal molds under heat and pressure.
- Ideal for new or remodel projects...fits the 3460M DURABASE® Shower Floor (see Accessories section).
- Fits 34" x 60" alcove.
- Embossed large tile pattern on back and side panels.
- Five panel wall system with tongue-and-groove seams that assemble quickly to create a watertight wall surround.
- Mounts direct-to-stud with mounting flanges hidden behind drywall or other wall treatment.
- Available in white.
- Smooth, colorfast deep gloss finish, resists scuffs.
- Mold and mildew-resistant...easy to clean.
- Available STYLEMATE® By-Pass shower enclosures feature tempered safety glass and a range of finishes (see Accessories section).
- Designed to support CareGiver® Grab Bars and Fold-Down Seats as needed (see Accessories section). Refer to installation sheet for mounting Grab Bars and Fold-Down Shower Seats.

Code Accepted

- American Society of Testing and Materials (ASTM) – D.635, E-84 and E-162
- American National Standards Institute (ANSI) - Specification ANSI Z 124-2011



Specifications

Model	Color	Fits Alcove	UPC
DURAWALL® Shower Wall			
760T-34WHT	White	34" x 60"	—
VARISTONE® Shelf			
572.300WHT	White	—	6 71031 00385 0

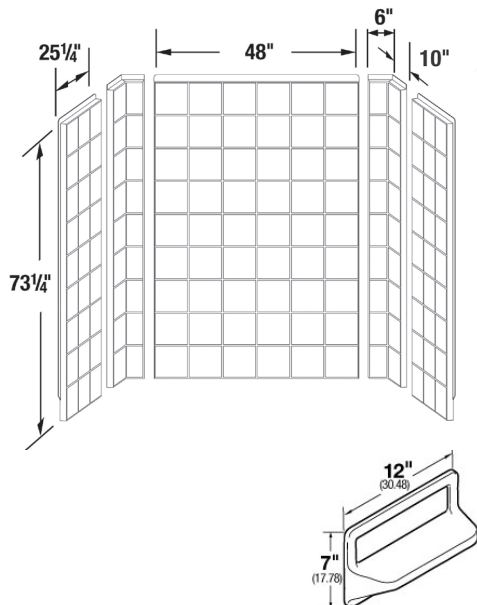

Panels with interlocking tongue-and-groove seams.

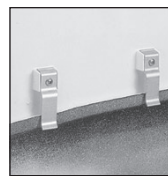

Reverse side of center panel has clips for securing to shower floor.



1-1/4" flanges fasten direct-to-studwalls with screws, drywall conceals flanges.

General: Furnish and install as shown on plans, DURAWALL® Shower Wall Model: 760T-34WHT, as manufactured by E. L. Mustee & Sons, Inc. Shall be semi-gloss 5-piece wall. Panels are molded fiberglass, using matched metal molds under extreme heat and pressure with a minimum uniform thickness of 125 mils and mount direct-to-studwalls. Includes center panel and two corner and side panels. Self-aligning panels using an interlocking tongue-and-groove seam. Shall meet ANSI Z 124-2011.2. Color: White.

General: Furnish and install as shown on plans, VARISTONE® Shower/Bathtub shelf Model 572.300 as manufactured by E.L. Mustee & Sons, Inc. Shall be semi-gloss, 1-piece molded shelf using matched metal molds under extreme heat and pressure. Shall meet ANSI Z 124-2011. Color: White



MUSTEE

E.L. Mustee & Sons, Inc. • 5431 West 164th Street • Brook Park, OH 44142 • Phone: 216.267.3100 • Fax: 216.267.9997
E-mail: info@mustee.com. • Web: www.mustee.com • Proudly made in the USA

Notice: Our continuous commitment to product improvement may result in changes to product specifications without notice. Patents pending. Made and Printed in U.S.A.



▶ **DURABASE® Fiberglass Rectangular Shower Floors**

DURABASE® fiberglass shower floor available for the 760T-34WHT DURAWALL® shower wall system include the 3460M DURABASE®.



Model No.	Description	Drain Location	Fits Alcove	UPC
3460M	White	Center	34" x 60"	6 71031 00123 8

▶ **CareGiver® Grab Bars — 1-1/2" Dia. Straight**

Straight 304 stainless steel grab bars provide in-shower support and stability.



Model No.	Size	UPC
390.305	18"	6 71031 00452 9
390.301	24"	6 71031 00359 1
390.306	36"	6 71031 00434 5
390.307	42"	6 71031 00435 2

1-1/2" Dia. Angled—Safety Grab Bars

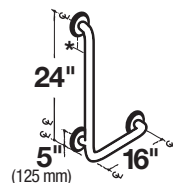

Model No.	AxB	C	UPC
390.308, LH	24" x 16"	90°	6 71031 00436 9
390.309, LH	32" x 16"	90°	6 71031 00437 6

LH= Left-Hand

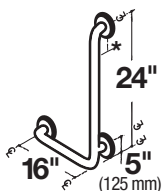

Model No.	AxB	C	UPC
390.310, RH	24" x 16"	90°	6 71031 00438 3
390.311, RH	32" x 16"	90°	6 71031 00439 0

RH= Right-Hand

Continued on next page ▶





► **CareGiver® Grab Bars — 1-1/2" Dia. Angled (continued)**

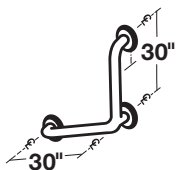

Model No.	AxB	C	UPC
390.312	30" x 30"	90°	6 71031 00440 6
390.313	12" x 12"	120°	6 71031 00441 3
390.314	16" x 16"	120°	6 71031 00442 0
390.315	24" x 24"	120°	6 71031 00443 7

Rotate for RH or LH use

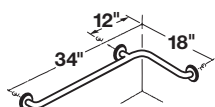

1-1/2" Dia. Inside Corner Styles—Safety Grab Bars

Model No.	AxB	C	UPC
390.304	34" x 18"	90°	6 71031 00362 1

► **CareGiver® Fold-Down Shower Seat**

CareGiver® Fold-Down Shower Seat provides a stable, secure place to sit while showering.



Rectangular Seat—Wall Mount

Model No.	Size	UPC
390.413	23" x 14-1/2"	6 71031 00486 4

► **Enclosures, Pivot and Bypass Doors**

Premium quality STYLEMATE® enclosures available for the 760T-30WHT DURAWALL® shower walls include...

STYLEMATE® — BY-PASS FRAMED AND BY-PASS FRAMELESS ENCLOSURES

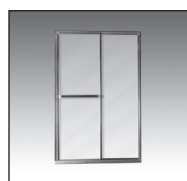

Model No.	Finish	Glass	Height	Opening	UPC
Framed Design					
60.403	Chrome	Clear	69"	59"	6 71031 00472 7
60.404	Brushed Nickel	Clear	69"	59"	6 71031 00473 4
60.405	Oil-Rubbed Bronze	Clear	69"	59"	6 71031 00474 1
Frameless Design					
60.406	Chrome	Clear	69"	59"	6 71031 00475 8
60.407	Brushed Nickel	Clear	69"	59"	6 71031 00476 5
60.408	Oil-Rubbed Bronze	Clear	69"	59"	6 71031 00477 2