

Manufactured from Swanstone Veritek®
(see page 2 for detailed information)

WARRANTY
Limited Lifetime – Residential
Limited 5-year – Commercial

FEATURES

- Elegant look of ceramic tile with no grout to clean
- Compression molded Veritek is a composite material with no surface coating to chip or crack
- Variety of sizes available for use with Swanstone, Veritek and other standard shower floors
- The TI-7260 is a glue-up 5-piece shower wall panel system

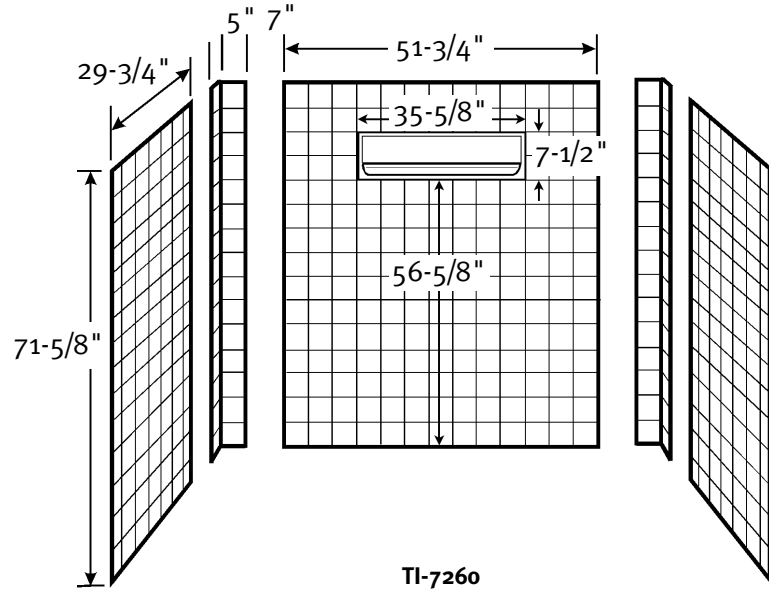

TI-7260

Designed to fit wall areas
31" – 36" deep x 53-1/4" – 64-3/4" wide x 71-5/8" high
(787 mm – 914 mm x 1314 mm – 1645 mm x 1819 mm)

SPECIFICATIONS

TI-7260 SwanTile Shower Wall Kit

Model	Part	Wall Area Designed To Fit	Ship Wt. Lb.	Ship UPS	Carton Dims. In.	Cu. Ft.
TI-7260	TI07260	31" – 36" D x 53-1/4" – 64-3/4" W x 71-5/8" H (787 mm – 914 mm x 1314 mm – 1645 mm x 1819 mm)	95	–	73 x 55 x 6	13.94

Kit Includes: One back panel with molded-in soap dish, two corner panels, two side panels, one roll of pressure sensitive tape, four tubes of adhesive, one tube of caulk and complete installation instructions.

Packaging: Each kit is packed in a flat, rectangular carton.

COLORS (See pg. 139 for color sample.)

- White (010)
- Bone (037)
- Bisque (018)

STANDARDS AND RATINGS

Class B fire rating
American Society for Testing and Materials
National Electrical Manufacturers Association

SUPPORT DOCUMENTS

Installation instructions available on line at www.swanstone.com

**MAINTENANCE AND
CLEANING INFORMATION**

Wash regularly with warm water, use soft cloth with mild liquid detergent. Scouring pads made of nylon, saran, or polyethylene may be used but NEVER USE ABRASIVE SCOURING POWDERS, CLEANSERS OR PADS...THEY DULL FINISH.