

# SPEAKMAN CHELSEA™

## Shower Combination SM-10430-P & SM-10410-P

SPECIFICATION

### FEATURES:

- Transitional styling
- S-3020 showerhead
- S-2500 shower arm & flange
- SM-10400-P diverter pressure balance shower valve & trim
- SM-10430-P includes S-1561 tub spout with slip-fit connection
- SM-10410-P without S-1561 tub spout

### COMPLIANCE:

- Certified to ASME A112.18.1 / CSA B125.1 and ASSE 1016 standards



### AVAILABLE FINISHES:

ADD SUFFIX TO MODEL #

- Polished Chrome (standard)
- Brushed Nickel  -BN

### WARRANTY:

- 1 year limited

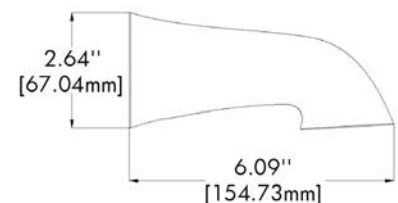
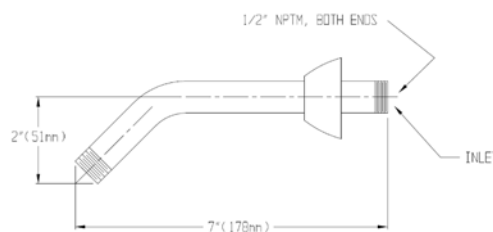
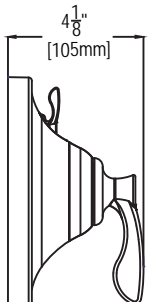
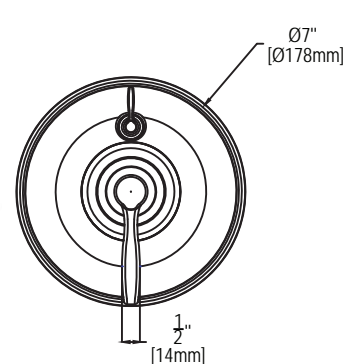
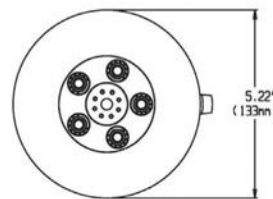
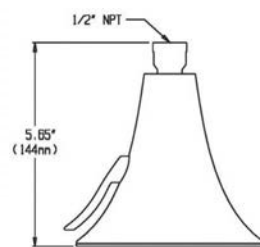
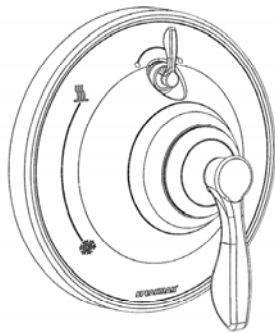
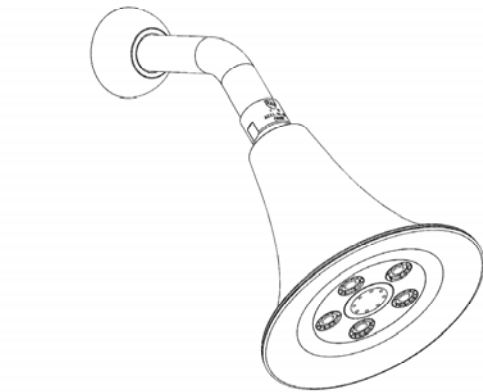

THIS SPACE FOR ARCHITECT/ENGINEER APPROVAL.

# SPEAKMAN®

400 ANCHOR MILL ROAD | NEW CASTLE, DE 19720  
P: 800-537-2107 | F: 800-977-2747  
WWW.SPEAKMANCOMPANY.COM

Management Systems  
Registered to ISO 9001

REVISION DATE: MAY 2013