

**TABLE OF CONTENTS**

Product Specifications .....	7-2
Quick Spec Guide .....	7-3
Elevations/Sizes: 1/4" Scale	
Picture .....	7-4
Quarter Round .....	7-17
Half Round .....	7-19
Full Round .....	7-20
Quarter Circle Segment .....	7-21
Circle Segment .....	7-22
Extended Quarter Round .....	7-23
Extended Half Round .....	7-24
Extended Quarter Segment .....	7-26
Extended Circle Segment .....	7-30
Sash Glazing Options: 4" Scale .....	7-34
Grilles & SDL Lite Patterns .....	7-35
Section Details: 4" Scale .....	7-39

---

**PRODUCT SPECIFICATIONS**

---

**MATERIALS**

Extruded vinyl profiles comply with the performance requirements of AAMA 303-97. Colors are White and Desert Sand. Available in the West.

**FRAME**

All frames are assembled utilizing fusion-welded technology for added strength and durability. Frame jamb depth is 3-1/4" (82.55mm), and the exterior wall thickness is 0.070 of an inch. Frames come standard with integral nailing fin that can be easily removed for replacement purposes. An optional integral dual-wall Flush Fin is available for some retrofit applications. Dual-wall Flush Fin is not available on radius and some geometric configurations.

**GLAZING**

3/4" (19mm) insulating glass consists of two lites of glass sealed around a spacer. All insulating glass units comply with the performance requirements of the IGCC in accordance with either ASTM E774 or E2190.

**GLAZING OPTIONS**

3/4" (19mm) insulated glass available in clear, Low-E, tinted, obscure, or other specialty insulating glass as specified. All glass is available tempered.

**GRILLES**

**SDL** (Simulated Divided Lite) - 7/8" (23mm), 1-1/8" (29mm), 1-3/8" (35mm), or 2-1/8" (58mm) contour grilles surface mounted on the exterior surfaces of the insulating glass, with shadow bars mounted between the glass panes suspended within the air cavity.

**GBG** (Grilles between the Glass) - 5/8" (16mm) flat or 1" (26mm) contour grilles mounted between the glass panes suspended within the air cavity and color matched to the extrusion color.

**INSTALLATION**

Installation per JELD-WEN Installation Method for Vinyl Windows JII001, JII010 or JII011. See [www.jeld-wen.com/resources](http://www.jeld-wen.com/resources) for instructions.

**PERFORMANCE**

**NFRC Certified** - (rated and labeled in accordance with NFRC)

**AAMA/NWDMA I.S.2-97**

































































R20-DP rated standard

Optional C35-DP rated (optional glazing required)

QUICK SPEC GUIDE

SPECIFICATION	STANDARD FEATURES	OPTIONAL FEATURES <i>Some options may require additional lead times. Consult your JELD-WEN Sales Representative.</i>
<b>COLOR</b>	<ul style="list-style-type: none"> <li>White</li> </ul>	<ul style="list-style-type: none"> <li>Desert Sand</li> </ul>
<b>SIZE (Rough Opening)</b>	<ul style="list-style-type: none"> <li>Width: 12" to 108"</li> <li>Height: 12" to 108"</li> <li>50 sq. foot max in single unit</li> </ul>	
<b>FRAME</b>	<ul style="list-style-type: none"> <li>Integral Nail Fin</li> </ul>	<ul style="list-style-type: none"> <li>Integral Dual Wall Flush Fin</li> <li>Dual wall flush fin not available on radius and some geometric configurations</li> <li>Pocket/Block Frame</li> </ul>
<b>GLAZING</b>	<ul style="list-style-type: none"> <li>Insulating Clear</li> </ul>	<ul style="list-style-type: none"> <li>Low-E</li> <li>Obscure</li> <li>Bronze</li> <li>Gray</li> <li>Gluechip</li> <li>Rain</li> <li>Azurlite</li> <li>Laminated</li> <li>All glass available tempered</li> </ul> <p><i>regional glass availabilities may differ</i></p>
<b>GRILLES</b>		<ul style="list-style-type: none"> <li>1" Contour GBG (grilles between the glass)</li> <li>5/8" Flat GBG (grilles between the glass)</li> <li>7/8", 1-1/8", 1-3/8", 2-1/8" SDL (simulated divided lites) profiles</li> </ul>
<b>JAMB DEPTH</b>	<ul style="list-style-type: none"> <li>3-1/4"</li> </ul>	

#### PICTURE UNITS











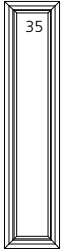

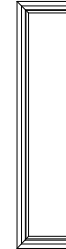

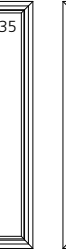

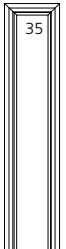

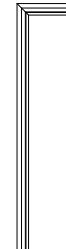

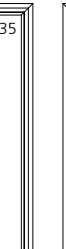

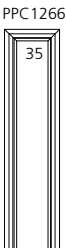

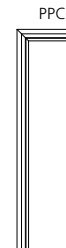

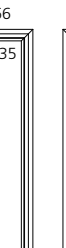

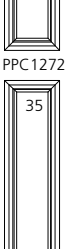
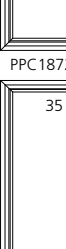

UNIT SIZE	13 3/4" (349)	19 3/4" (502)	23 3/4" (603)	25 3/4" (654)	27 3/4" (705)	31 3/4" (806)	33 3/4" (857)	35 3/4" (908)
ROUGH OPENING	12" (305)	18" (457)	22" (559)	24" (610)	26" (660)	30" (762)	32" (813)	34" (864)
FRAME SIZE	11 1/2" (292)	17 1/2" (445)	21 1/2" (546)	23 1/2" (597)	25 1/2" (648)	29 1/2" (749)	31 1/2" (800)	33 1/2" (851)
DAYLIGHT OPENING	7 7/8" (200)	13 7/8" (352)	17 7/8" (454)	19 7/8" (505)	21 7/8" (556)	25 7/8" (657)	27 7/8" (708)	29 7/8" (759)
13 3/4" (349) 12" (305) 11 1/2" (292) 7 7/8" (200)								
19 3/4" (502) 18" (457) 17 1/2" (445) 13 7/8" (352)								
25 3/4" (654) 24" (610) 23 1/2" (597) 19 7/8" (505)								
31 3/4" (806) 30" (762) 29 1/2" (749) 25 7/8" (657)								
37 3/4" (959) 36" (914) 35 1/2" (902) 31 7/8" (810)								
43 3/4" (1111) 42" (1067) 41 1/2" (1054) 37 7/8" (962)								
49 3/4" (1264) 48" (1219) 47 1/2" (1207) 43 7/8" (1114)								
55 3/4" (1416) 54" (1372) 53 1/2" (1359) 49 7/8" (1267)								

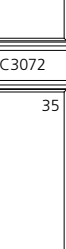
**ELEVATION SYMBOL LEGEND:**  
 VALUES IN ( ) ARE IN MILLIMETER CONVERSIONS  
 ## INDICATES DESIGN PRESSURE (DP) RATING WITH STANDARD GLAZING

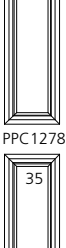
Note: Elevations shown DO NOT have exterior trim. Subtract 1/2" (12.7) from M.O. (Masonry Opening) for Unit Sizes. Masonry openings above include Sill Nose, see Trim Options page for Sill Nose specifications. For other Trim Options refer to the Unit Sizing, Rough Opening & Masonry Openings page.

SCALE: 1/4" = 1'

#### PICTURE UNITS

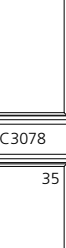
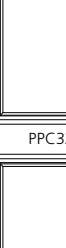
	13 3/4" (349)	19 3/4" (502)	23 3/4" (603)	25 3/4" (654)	27 3/4" (705)	31 3/4" (806)	33 3/4" (857)	35 3/4" (908)	
UNIT SIZE									
ROUGH OPENING	12" (305)	18" (457)	22" (559)	24" (610)	26" (660)	30" (762)	32" (813)	34" (864)	
FRAME SIZE	11 1/2" (292)	17 1/2" (445)	21 1/2" (546)	23 1/2" (597)	25 1/2" (648)	29 1/2" (749)	31 1/2" (800)	33 1/2" (851)	
DAYLIGHT OPENING	7 7/8" (200)	13 7/8" (352)	17 7/8" (454)	19 7/8" (505)	21 7/8" (556)	25 7/8" (657)	27 7/8" (708)	29 7/8" (759)	
61 3/4" (1568) 60" (1524) 59 1/2" (1511) 55 7/8" (1419)									
	PPC1260	PPC1860	PPC2260	PPC2460	PPC2660	PPC3060	PPC3260	PPC3460	
	67 3/4" (1721) 66" (1676) 65 1/2" (1664) 61 7/8" (1572)								
		PPC1266	PPC1866	PPC2266	PPC2466	PPC2666	PPC3066	PPC3266	PPC3466
73 3/4" (1873) 72" (1829) 71 1/2" (1816) 67 7/8" (1724)									
		PPC1272	PPC1872	PPC2272	PPC2472	PPC2672	PPC3072	PPC3272	PPC3472
	79 3/4" (2026) 78" (1981) 77 1/2" (1969) 73 7/8" (1876)								
		PPC1278	PPC1878	PPC2278	PPC2478	PPC2678	PPC3078	PPC3278	PPC3478
85 3/4" (2178) 84" (2134) 83 1/2" (2121) 79 7/8" (2029)									
		PPC1284	PPC1884	PPC2284	PPC2484	PPC2684	PPC3084	PPC3284	PPC3484

SCALE: 1/4" = 1'

### PICTURE UNITS

UNIT SIZE	13 3/4" (349)	19 3/4" (502)	23 3/4" (603)	25 3/4" (654)	27 3/4" (705)	31 3/4" (806)	33 3/4" (857)	35 3/4" (908)	
ROUGH OPENING	12" (305)	18" (457)	22" (559)	24" (610)	26" (660)	30" (762)	32" (813)	34" (864)	
FRAME SIZE	11 1/2" (292)	17 1/2" (445)	21 1/2" (546)	23 1/2" (597)	25 1/2" (648)	29 1/2" (749)	31 1/2" (800)	33 1/2" (851)	
DAYLIGHT OPENING	7 7/8" (200)	13 7/8" (352)	17 7/8" (454)	19 7/8" (505)	21 7/8" (556)	25 7/8" (657)	27 7/8" (708)	29 7/8" (759)	
91 3/4" (2330) 90" (2286) 89 1/2" (2273) 85 7/8" (2181)									
	PPC1290	PPC1890	PPC2290	PPC2490	PPC2690	PPC3090	PPC3290	PPC3490	
	97 3/4" (2483) 96" (2438) 95 1/2" (2426) 91 7/8" (2334)								
		PPC1296	PPC1896	PPC2296	PPC2496	PPC2696	PPC3096	PPC3296	PPC3496

**ELEVATION SYMBOL LEGEND:**

VALUES IN ( ) ARE IN MILLIMETER CONVERSIONS

## INDICATES DESIGN PRESSURE (DP) RATING WITH STANDARD GLAZING

Note: Elevations shown DO NOT have exterior trim. Subtract 1/2" (12.7) from M.O. (Masonry Opening) for Unit Sizes. Masonry openings above include Sill Nose, see Trim Options page for Sill Nose specifications. For other Trim Options refer to the Unit Sizing, Rough Opening & Masonry Openings page.

SCALE: 1/4" = 1'

### PICTURE UNITS

UNIT SIZE ROUGH OPENING FRAME SIZE DAYLIGHT OPENING	37 3/4"(959) 36"(914) 35 1/2"(902) 31 7/8"(810)	39 3/4"(1010) 38"(965) 37 1/2"(953) 33 7/8"(860)	43 3/4"(1111) 42"(1067) 41 1/2"(1054) 37 7/8"(962)	49 3/4"(1264) 48"(1219) 47 1/2"(1207) 43 7/8"(1114)	55 3/4"(1416) 54"(1372) 53 1/2"(1359) 49 7/8"(1267)
13 3/4"(349) 12"(305) 11 1/2"(292) 7 7/8"(200)					
19 3/4"(502) 18"(457) 17 1/2"(445) 13 7/8"(352)					
25 3/4"(654) 24"(610) 23 1/2"(597) 19 7/8"(505)					
31 3/4"(806) 30"(762) 29 1/2"(749) 25 7/8"(657)					
37 3/4"(959) 36"(914) 35 1/2"(902) 31 7/8"(810)					
43 3/4"(1111) 42"(1067) 41 1/2"(1054) 37 7/8"(962)					
49 3/4"(1264) 48"(1219) 47 1/2"(1207) 43 7/8"(1114)					
55 3/4"(1416) 54"(1372) 53 1/2"(1359) 49 7/8"(1267)					

**ELEVATION SYMBOL LEGEND:**

VALUES IN ( ) ARE IN MILLIMETER CONVERSIONS

## INDICATES DESIGN PRESSURE (DP) RATING WITH STANDARD GLAZING

Note: Elevations shown DO NOT have exterior trim. Subtract 1/2"(12.7) from M.O.(Masonry Opening) for Unit Sizes. Masonry openings above include Sill Nose, see Trim Options page for Sill Nose specifications. For other Trim Options refer to the Unit Sizing, Rough Opening & Masonry Openings page.

SCALE: 1/4" = 1'

#### PICTURE UNITS

UNIT SIZE  
ROUGH OPENING  
FRAME SIZE  
DAYLIGHT OPENING

37 3/4"(959)  
36"(914)  
35 1/2"(902)  
31 7/8"(810)

39 3/4"(1010)  
38"(965)  
37 1/2"(953)  
33 7/8"(860)

43 3/4"(1111)  
42"(1067)  
41 1/2"(1054)  
37 7/8"(962)

49 3/4"(1264)  
48"(1219)  
47 1/2"(1207)  
43 7/8"(1114)

55 3/4"(1416)  
54"(1372)  
53 1/2"(1359)  
49 7/8"(1267)

61 3/4"(1568)  
60"(1524)  
59 1/2"(1511)  
55 7/8"(1419)

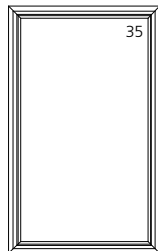

PPC3660

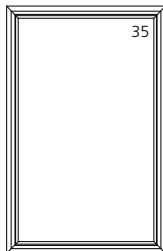

PPC3860

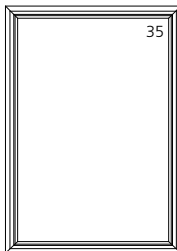

PPC4260

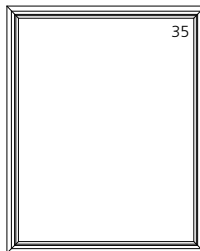

PPC4860

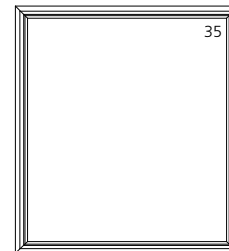

PPC5460

67 3/4"(1721)  
66"(1676)  
65 1/2"(1664)  
61 7/8"(1572)

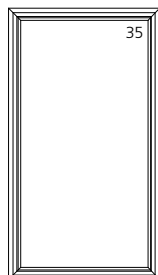

PPC3666

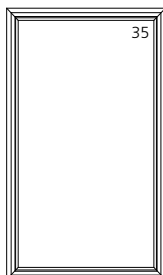

PPC3866

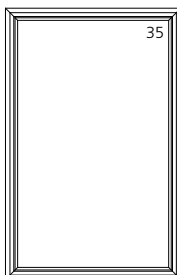

PPC4266

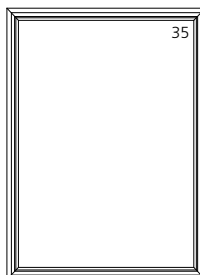

PPC4866

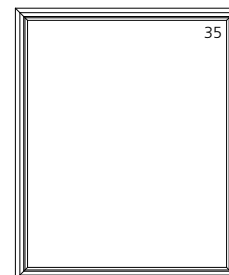

PPC5466

73 3/4"(1873)  
72"(1829)  
71 1/2"(1816)  
67 7/8"(1724)

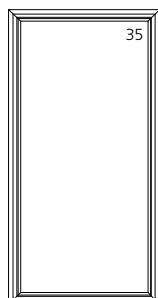

PPC3672

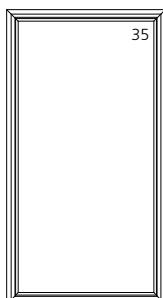

PPC3872

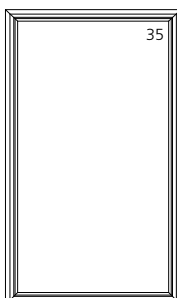

PPC4272

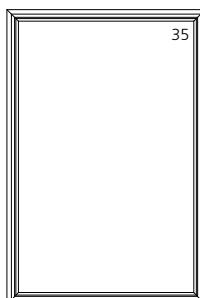

PPC4872

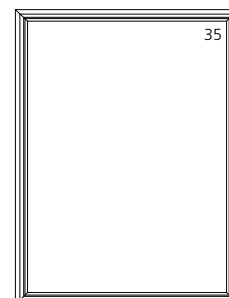

PPC5472

79 3/4"(2026)  
78"(1981)  
77 1/2"(1969)  
73 7/8"(1876)

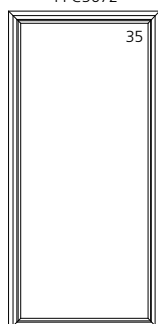

PPC3678

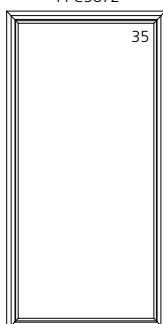

PPC3878

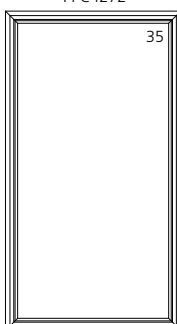

PPC4278

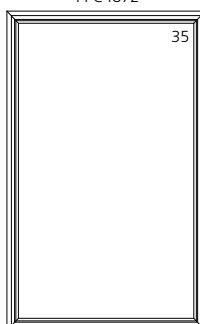

PPC4878

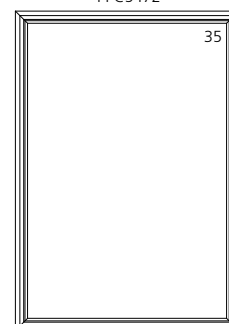

PPC5478

85 3/4"(2178)  
84"(2134)  
83 1/2"(2121)  
79 7/8"(2029)

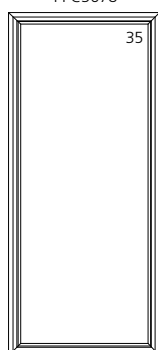

PPC3684

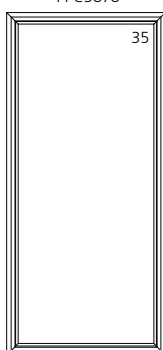

PPC3884

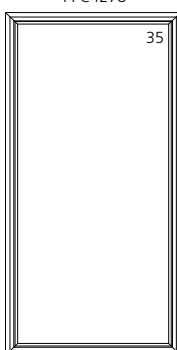

PPC4284

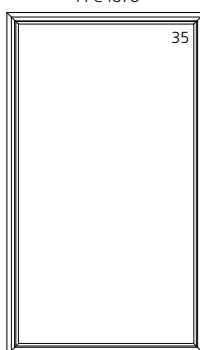

PPC4884

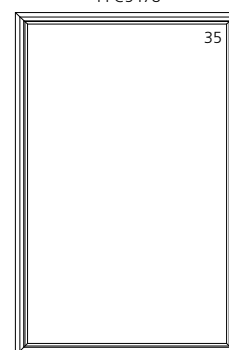

PPC5484

SCALE: 1/4" = 1'

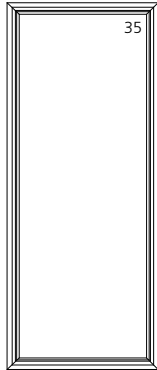
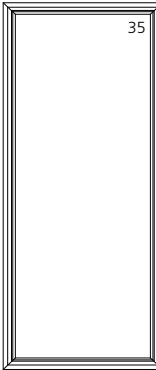
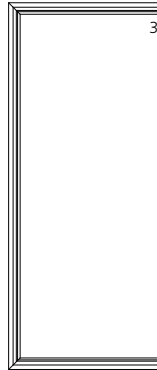
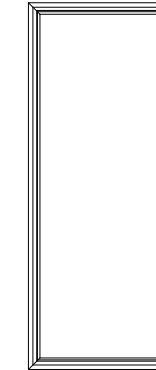
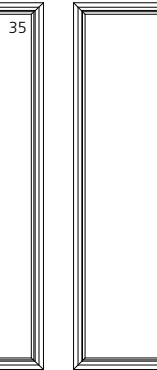
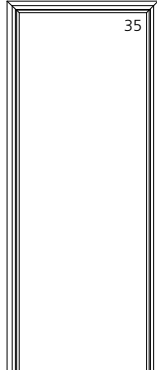
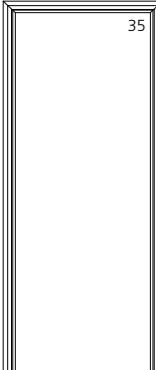
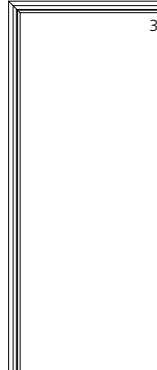
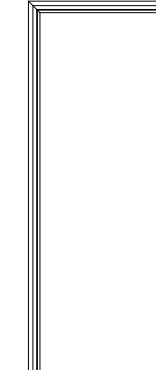
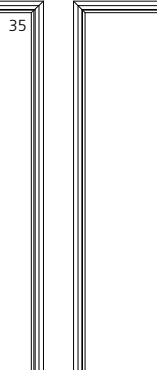

**PICTURE UNITS**

	37 3/4"(959)	39 3/4"(1010)	43 3/4"(1111)	49 3/4"(1264)	55 3/4"(1416)
<b>UNIT SIZE</b>	37 3/4"(959)	39 3/4"(1010)	43 3/4"(1111)	49 3/4"(1264)	55 3/4"(1416)
<b>ROUGH OPENING</b>	36"(914)	38"(965)	42"(1067)	48"(1219)	54"(1372)
<b>FRAME SIZE</b>	35 1/2"(902)	37 1/2"(953)	41 1/2"(1054)	47 1/2"(1207)	53 1/2"(1359)
<b>DAYLIGHT OPENING</b>	31 7/8"(810)	33 7/8"(860)	37 7/8"(962)	43 7/8"(1114)	49 7/8"(1267)
					
	PPC3690	PPC3890	PPC4290	PPC4890	PPC5490
					
	PPC3696	PPC3896	PPC4296	PPC4896	PPC5496

91 3/4"(2330)  
90"(2286)  
89 1/2"(2273)  
85 7/8"(2181)

















97 3/4"(2483)  
96"(2438)  
95 1/2"(2426)  
91 7/8"(2334)

**ELEVATION SYMBOL LEGEND:**  
VALUES IN ( ) ARE IN MILLIMETER CONVERSIONS  
## INDICATES DESIGN PRESSURE (DP) RATING WITH STANDARD GLAZING

Note: Elevations shown DO NOT have exterior trim. Subtract 1/2"(12.7) from M.O.(Masonry Opening) for Unit Sizes. Masonry openings above include Sill Nose, see Trim Options page for Sill Nose specifications. For other Trim Options refer to the Unit Sizing, Rough Opening & Masonry Openings page.

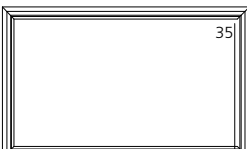
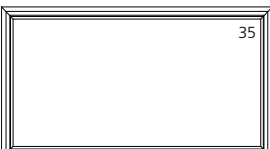
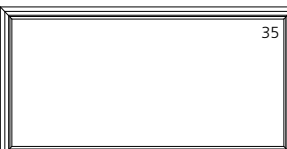
SCALE: 1/4" = 1'

### PICTURE UNITS

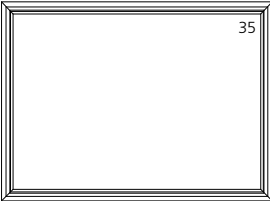
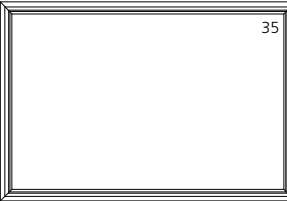
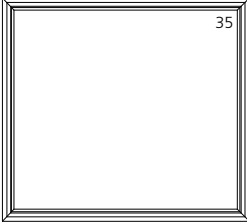
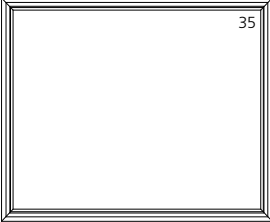
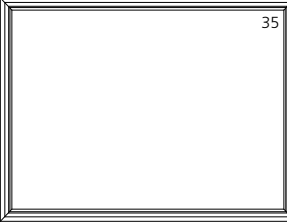
UNIT SIZE ROUGH OPENING FRAME SIZE DAYLIGHT OPENING	61 3/4" (1568) 60" (1524) 59 1/2" (1511) 55 7/8" (1419)	67 3/4" (1721) 66" (1676) 65 1/2" (1664) 61 7/8" (1572)	73 3/4" (1873) 72" (1829) 71 1/2" (1816) 67 7/8" (1724)
13 3/4" (349) 12" (305) 11 1/2" (292) 7 7/8" (200)	 PPC6012	 PPC6612	 PPC7212
19 3/4" (502) 18" (457) 17 1/2" (445) 13 7/8" (352)	 PPC6018	 PPC6618	 PPC7218
25 3/4" (654) 24" (610) 23 1/2" (597) 19 7/8" (505)	 PPC6024	 PPC6624	 PPC7224
31 3/4" (806) 30" (762) 29 1/2" (749) 25 7/8" (657)	 PPC6030	 PPC6630	 PPC7230
37 3/4" (959) 36" (914) 35 1/2" (902) 31 7/8" (810)	 PPC6036	 PPC6636	 PPC7236
43 3/4" (1111) 42" (1067) 41 1/2" (1054) 37 7/8" (962)	 PPC6042	 PPC6642	 PPC7242
49 3/4" (1264) 48" (1219) 47 1/2" (1207) 43 7/8" (1114)	 PPC6048	 PPC6648	 PPC7248
55 3/4" (1416) 54" (1372) 53 1/2" (1359) 49 7/8" (1267)	 PPC6054	 PPC6654	 PPC7254

**ELEVATION SYMBOL LEGEND:**

VALUES IN ( ) ARE IN MILLIMETER CONVERSIONS

## INDICATES DESIGN PRESSURE (DP) RATING WITH STANDARD GLAZING

Note: Elevations shown DO NOT have exterior trim. Subtract 1/2" (12.7) from M.O. (Masonry Opening) for Unit Sizes. Masonry openings above include Sill Nose, see Trim Options page for Sill Nose specifications. For other Trim Options refer to the Unit Sizing, Rough Opening & Masonry Openings page.

SCALE: 1/4" = 1'

**PICTURE UNITS**

**UNIT SIZE**  
**ROUGH OPENING**  
**FRAME SIZE**  
**DAYLIGHT OPENING**

61 3/4" (1568)  
60" (1524)  
59 1/2" (1511)  
55 7/8" (1419)

67 3/4" (1721)  
66" (1676)  
65 1/2" (1664)  
61 7/8" (1572)

73 3/4" (1873)  
72" (1829)  
71 1/2" (1816)  
67 7/8" (1724)

61 3/4" (1568)  
60" (1524)  
59 1/2" (1511)  
55 7/8" (1419)

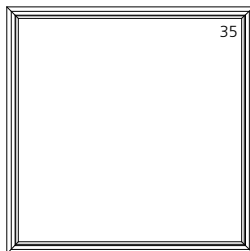

PPC6060

67 3/4" (1721)  
66" (1676)  
65 1/2" (1664)  
61 7/8" (1572)

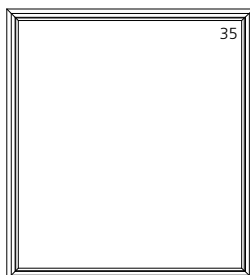

PPC6066

73 3/4" (1873)  
72" (1829)  
71 1/2" (1816)  
67 7/8" (1724)

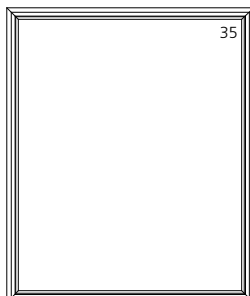

PPC6072

79 3/4" (2026)  
78" (1981)  
77 1/2" (1969)  
73 7/8" (1876)

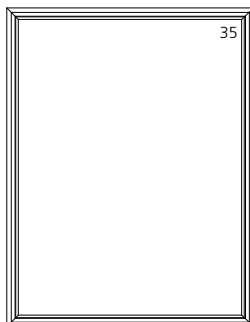

PPC6078

85 3/4" (2178)  
84" (2134)  
83 1/2" (2121)  
79 7/8" (2029)

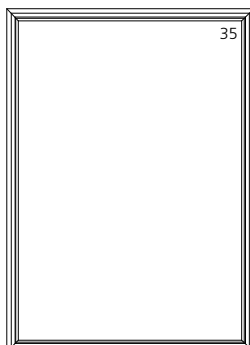

PPC6084

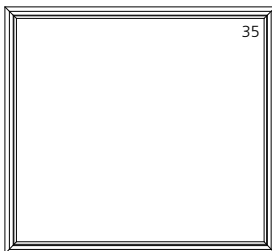

PPC6660

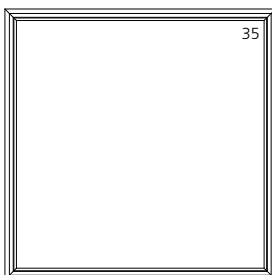

PPC6666

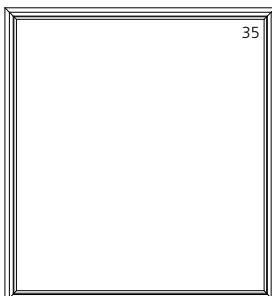

PPC6672

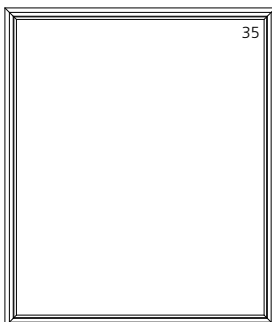

PPC6678

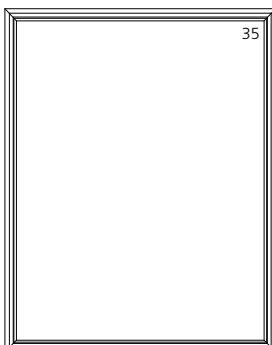

PPC6684

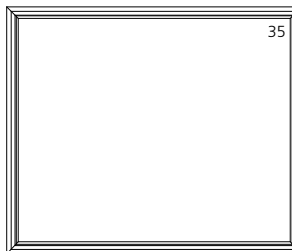

PPC7260

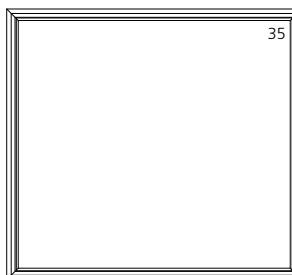

PPC7266

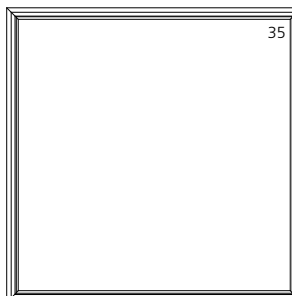

PPC7272

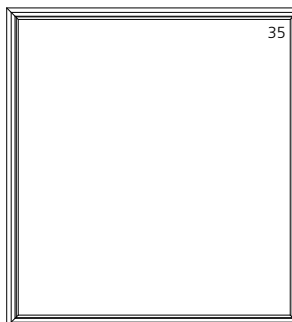

PPC7278

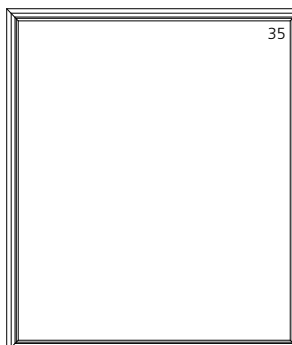

PPC7284

SCALE: 1/4" = 1'

**PICTURE UNITS**

**UNIT SIZE**  
**ROUGH OPENING**  
**FRAME SIZE**  
**DAYLIGHT OPENING**

61 3/4"(1568)  
60"(1524)  
59 1/2"(1511)  
55 7/8"(1419)

67 3/4"(1721)  
66"(1676)  
65 1/2"(1664)  
61 7/8"(1572)

73 3/4"(1873)  
72"(1829)  
71 1/2"(1816)  
67 7/8"(1724)

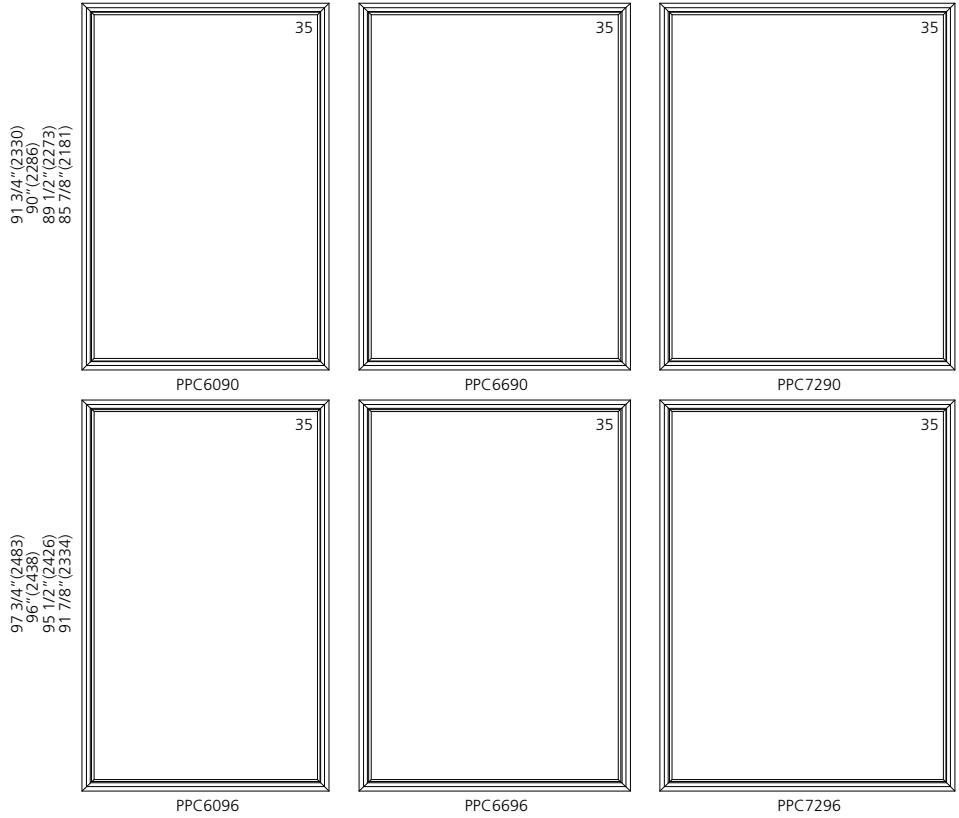

**ELEVATION SYMBOL LEGEND:**

VALUES IN ( ) ARE IN MILLIMETER CONVERSIONS

## INDICATES DESIGN PRESSURE (DP) RATING WITH STANDARD GLAZING

Note: Elevations shown DO NOT have exterior trim. Subtract 1/2"(12.7) from M.O.(Masonry Opening) for Unit Sizes. Masonry openings above include Sill Nose, see Trim Options page for Sill Nose specifications. For other Trim Options refer to the Unit Sizing, Rough Opening & Masonry Openings page.

SCALE: 1/4" = 1'

**PICTURE UNITS**

**UNIT SIZE**  
**ROUGH OPENING**  
**FRAME SIZE**  
**DAYLIGHT OPENING**

79 3/4"(2026)  
78"(1981)  
77 1/2"(1969)  
73 7/8"(1876)

85 3/4"(2178)  
84"(2134)  
83 1/2"(2121)  
79 7/8"(2029)

91 3/4"(2330)  
90"(2286)  
89 1/2"(2273)  
85 7/8"(2181)

13 3/4"(349)  
12"(305)  
11 1/2"(292)  
7 7/8"(200)

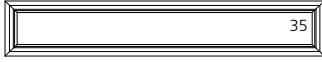

PPC7812

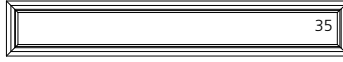

PPC8412

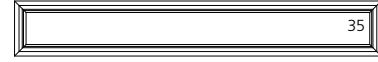

PPC9012

19 3/4"(502)  
18"(457)  
17 1/2"(445)  
13 7/8"(352)



PPC7818



PPC8418



PPC9018

25 3/4"(654)  
24"(610)  
23 1/2"(597)  
19 7/8"(505)



PPC7824



PPC8424



PPC9024

31 3/4"(806)  
30"(762)  
29 1/2"(749)  
25 7/8"(657)



PPC7830



PPC8430



PPC9030

37 3/4"(959)  
36"(914)  
35 1/2"(902)  
31 7/8"(810)

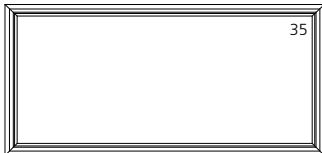

PPC7836



PPC8436



PPC9036

43 3/4"(1111)  
42"(1067)  
41 1/2"(1054)  
37 7/8"(962)

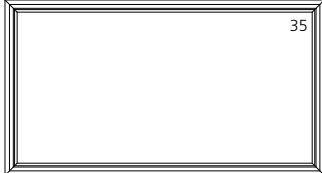

PPC7842

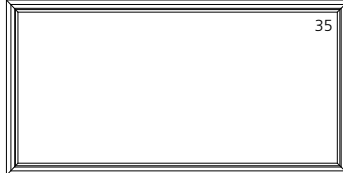

PPC8442

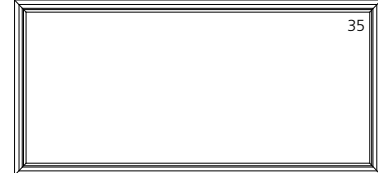

PPC9042

49 3/4"(1264)  
48"(1219)  
47 1/2"(1207)  
43 7/8"(1114)

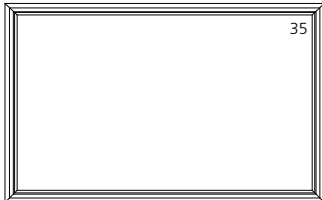

PPC7848

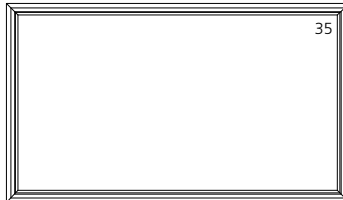

PPC8448

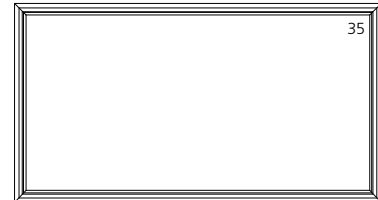

PPC9048

55 3/4"(1416)  
54"(1372)  
53 1/2"(1359)  
49 7/8"(1267)

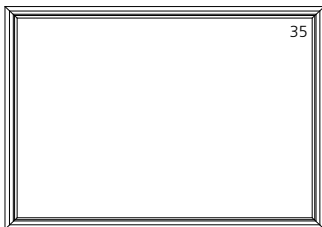

PPC7854

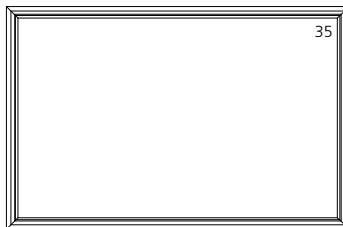

PPC8454

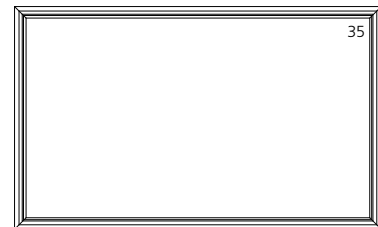

PPC9054

**ELEVATION SYMBOL LEGEND:**

VALUES IN ( ) ARE IN MILLIMETER CONVERSIONS

## INDICATES DESIGN PRESSURE (DP) RATING WITH STANDARD GLAZING

Note: Elevations shown DO NOT have exterior trim. Subtract 1/2"(12.7) from M.O.(Masonry Opening) for Unit Sizes. Masonry openings above include Sill Nose, see Trim Options page for Sill Nose specifications. For other Trim Options refer to the Unit Sizing, Rough Opening & Masonry Openings page.

SCALE: 1/4" = 1'

**PICTURE UNITS**

UNIT SIZE  
ROUGH OPENING  
FRAME SIZE  
DAYLIGHT OPENING

79 3/4" (2026)  
78" (1981)  
77 1/2" (1969)  
73 7/8" (1876)

85 3/4" (2178)  
84" (2134)  
83 1/2" (2121)  
79 7/8" (2029)

91 3/4" (2330)  
90" (2286)  
89 1/2" (2273)  
85 7/8" (2181)

61 3/4" (1568)  
60" (1524)  
59 1/2" (1511)  
55 7/8" (1419)

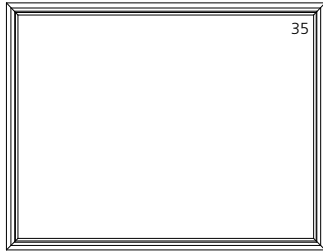

PPC7860

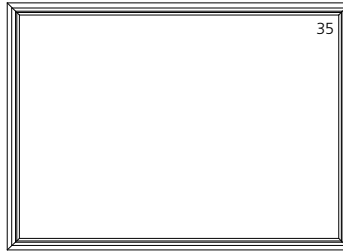

PPC8460

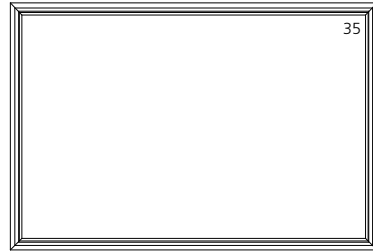

PPC9060

67 3/4" (1721)  
66" (1676)  
65 1/2" (1664)  
61 7/8" (1572)



PPC7866

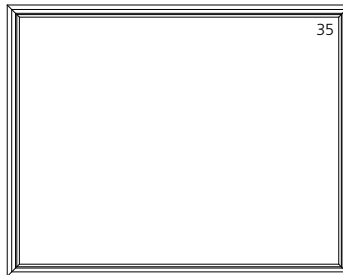

PPC8466

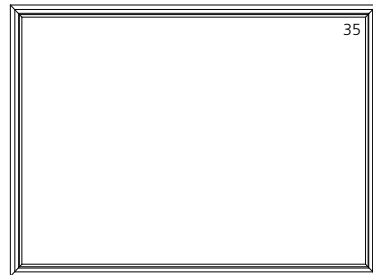

PPC9066

73 3/4" (1873)  
72" (1829)  
71 1/2" (1816)  
67 7/8" (1724)



PPC7872



PPC8472



PPC9072

79 3/4" (2026)  
78" (1981)  
77 1/2" (1969)  
73 7/8" (1876)

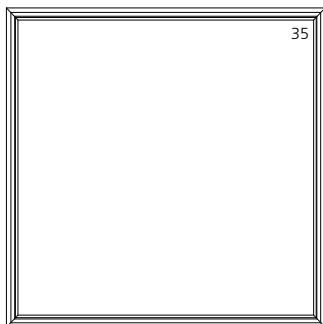

PPC7878



PPC8478

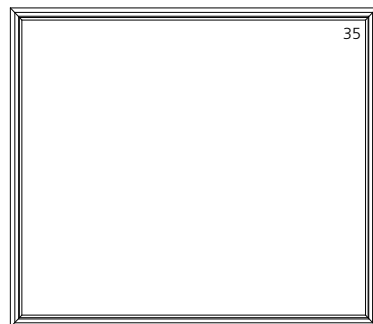

PPC9078

85 3/4" (2178)  
84" (2134)  
83 1/2" (2121)  
79 7/8" (2029)

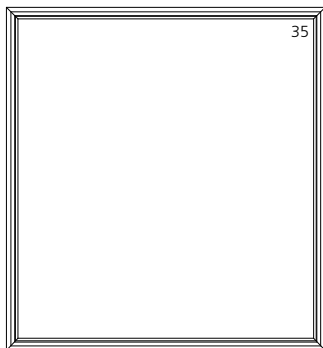

PPC7884

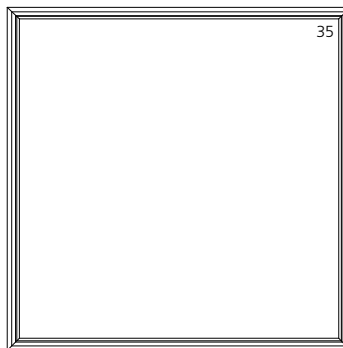

PPC8484

SCALE: 1/4" = 1'

**PICTURE UNITS**

UNIT SIZE	79 3/4"(2026)
ROUGH OPENING	78"(1981)
FRAME SIZE	77 1/2"(1969)
DAYLIGHT OPENING	73 7/8"(1876)

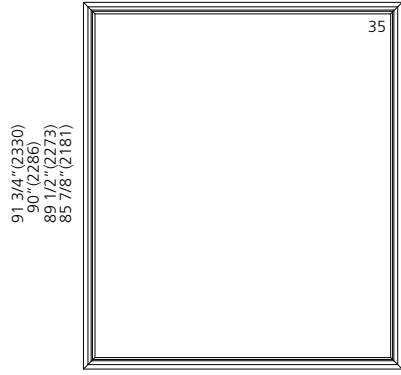

**ELEVATION SYMBOL LEGEND:**

VALUES IN ( ) ARE IN MILLIMETER CONVERSIONS

## INDICATES DESIGN PRESSURE (DP) RATING WITH STANDARD GLAZING

Note: Elevations shown DO NOT have exterior trim. Subtract 1/2"(12.7) from M.O.(Masonry Opening) for Unit Sizes. Masonry openings above include Sill Nose, see Trim Options page for Sill Nose specifications. For other Trim Options refer to the Unit Sizing, Rough Opening & Masonry Openings page.

SCALE: 1/4" = 1'

#### PICTURE UNITS

UNIT SIZE  
ROUGH OPENING  
FRAME SIZE  
DAYLIGHT OPENING

97 3/4"(2483)  
96"(2438)  
95 1/2"(2426)  
91 7/8"(2334)



PPC9612



PPC9618



PPC9624



PPC9630



PPC9636

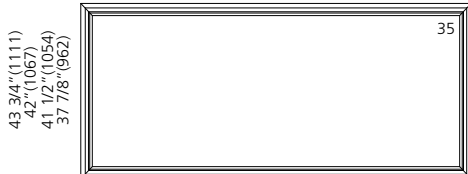

PPC9642

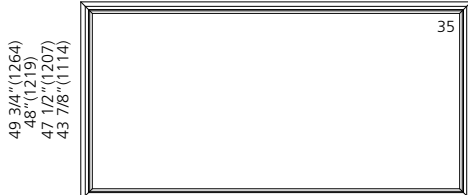

PPC9648

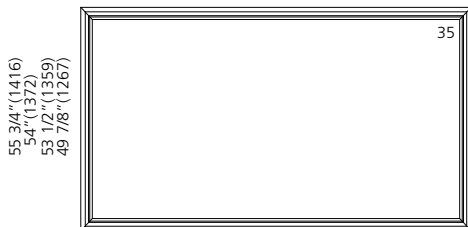

PPC9654

UNIT SIZE  
ROUGH OPENING  
FRAME SIZE  
DAYLIGHT OPENING

97 3/4"(2483)  
96"(2438)  
95 1/2"(2426)  
91 7/8"(2334)



PPC9660



PPC9666



PPC9672

**ELEVATION SYMBOL LEGEND:**

VALUES IN ( ) ARE IN MILLIMETER CONVERSIONS

## INDICATES DESIGN PRESSURE (DP) RATING WITH STANDARD GLAZING

Note: Elevations shown DO NOT have exterior trim. Subtract 1/2"(12.7) from M.O.(Masonry Opening) for Unit Sizes. Masonry openings above include Sill Nose, see Trim Options page for Sill Nose specifications. For other Trim Options refer to the Unit Sizing, Rough Opening & Masonry Openings page.

SCALE: 1/4" = 1'



#### QUARTER ROUND

**UNIT SIZE**  
**ROUGH OPENING**  
**FRAME SIZE**  
**DAYLIGHT OPENING**

19 3/4" (502)  
18" (457)  
17 1/2" (445)  
13 7/8" (352)

19 3/4" (502)  
18" (457)  
17 1/2" (445)  
13 7/8" (352)

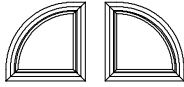

PQR1818

23 3/4" (603)  
22" (559)  
21 1/2" (546)  
17 7/8" (454)

23 3/4" (603)  
22" (559)  
21 1/2" (546)  
17 7/8" (454)

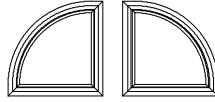

PQR2222

25 3/4" (654)  
24" (610)  
23 1/2" (597)  
19 7/8" (505)

25 3/4" (654)  
24" (610)  
23 1/2" (597)  
19 7/8" (505)

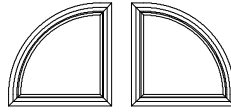

PQR2424

27 3/4" (705)  
26" (660)  
25 1/2" (648)  
21 7/8" (556)

27 3/4" (705)  
26" (660)  
25 1/2" (648)  
21 7/8" (556)

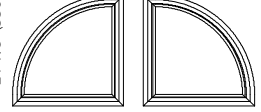

PQR2626

**UNIT SIZE**  
**ROUGH OPENING**  
**FRAME SIZE**  
**DAYLIGHT OPENING**

31 3/4" (806)  
30" (762)  
29 1/2" (749)  
25 7/8" (657)

31 3/4" (806)  
30" (762)  
29 1/2" (749)  
25 7/8" (657)

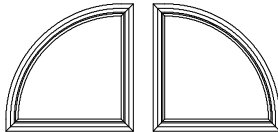

PQR3030

33 3/4" (857)  
32" (813)  
31 1/2" (800)  
27 7/8" (708)

33 3/4" (857)  
32" (813)  
31 1/2" (800)  
27 7/8" (708)



PQR3232

35 3/4" (908)  
34" (864)  
33 1/2" (851)  
29 7/8" (759)

35 3/4" (908)  
34" (864)  
33 1/2" (851)  
29 7/8" (759)

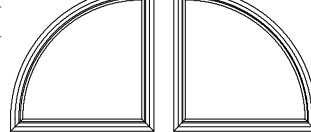

PQR3434

**UNIT SIZE**  
**ROUGH OPENING**  
**FRAME SIZE**  
**DAYLIGHT OPENING**

37 3/4" (959)  
36" (914)  
35 1/2" (902)  
31 7/8" (810)

37 3/4" (959)  
36" (914)  
35 1/2" (902)  
31 7/8" (810)

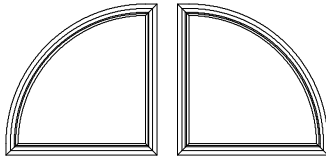

PQR3636

39 3/4" (1010)  
38" (965)  
37 1/2" (953)  
33 7/8" (860)

39 3/4" (1010)  
38" (965)  
37 1/2" (953)  
33 7/8" (860)

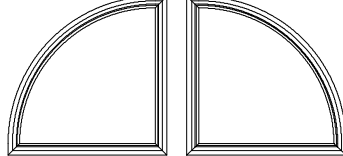

PQR3838

**UNIT SIZE**  
**ROUGH OPENING**  
**FRAME SIZE**  
**DAYLIGHT OPENING**

43 3/4" (1111)  
42" (1067)  
41 1/2" (1054)  
37 7/8" (962)

43 3/4" (1111)  
42" (1067)  
41 1/2" (1054)  
37 7/8" (962)

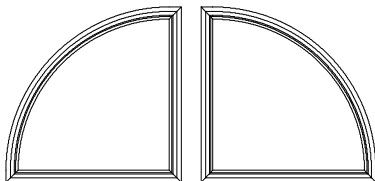

PQR4242

49 3/4" (1264)  
48" (1219)  
47 1/2" (1207)  
43 7/8" (1114)

49 3/4" (1264)  
48" (1219)  
47 1/2" (1207)  
43 7/8" (1114)

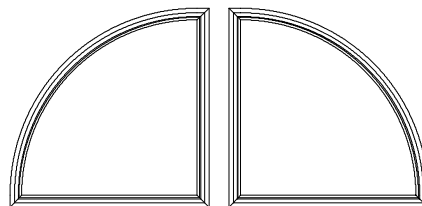

PQR4848

**ELEVATION SYMBOL LEGEND:**

VALUES IN ( ) ARE IN MILLIMETER CONVERSIONS

## INDICATES DESIGN PRESSURE (DP) RATING WITH STANDARD GLAZING

Note: Elevations shown DO NOT have exterior trim. Subtract 1/2" (12.7) from M.O. (Masonry Opening) for Unit Sizes. Masonry openings above include Sill Nose, see Trim Options page for Sill Nose specifications. For other Trim Options refer to the Unit Sizing, Rough Opening & Masonry Openings page.

SCALE: 1/4" = 1'

**QUARTER ROUND**

**UNIT SIZE**  
**ROUGH OPENING**  
**FRAME SIZE**  
**DAYLIGHT OPENING**

55 3/4"(1416)  
54"(1372)  
53 1/2"(1359)  
49 7/8"(1267)

55 3/4"(1416)  
54"(1372)  
53 1/2"(1359)  
49 7/8"(1267)

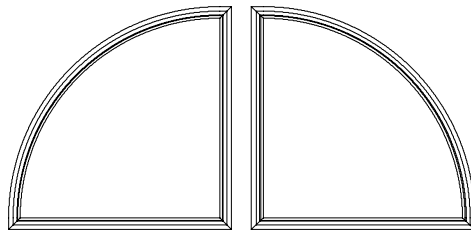

PQR5454

61 3/4"(1568)  
60"(1524)  
59 1/2"(1511)  
55 7/8"(1419)

61 3/4"(1568)  
60"(1524)  
59 1/2"(1511)  
55 7/8"(1419)

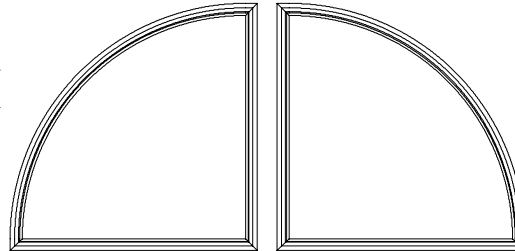

PQR6060

**UNIT SIZE**  
**ROUGH OPENING**  
**FRAME SIZE**  
**DAYLIGHT OPENING**

67 3/4"(1721)  
66"(1676)  
65 1/2"(1664)  
61 7/8"(1572)

67 3/4"(1721)  
66"(1676)  
65 1/2"(1664)  
61 7/8"(1572)

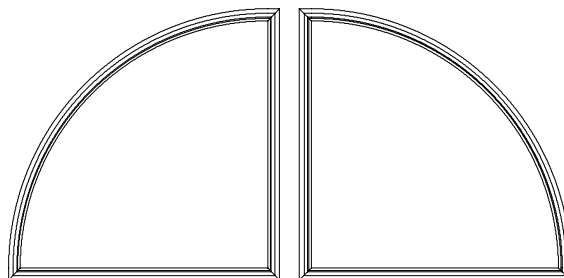

PQR6666

**UNIT SIZE**  
**ROUGH OPENING**  
**FRAME SIZE**  
**DAYLIGHT OPENING**

73 3/4"(1873)  
72"(1829)  
71 1/2"(1816)  
67 7/8"(1724)

73 3/4"(1873)  
72"(1829)  
71 1/2"(1816)  
67 7/8"(1724)

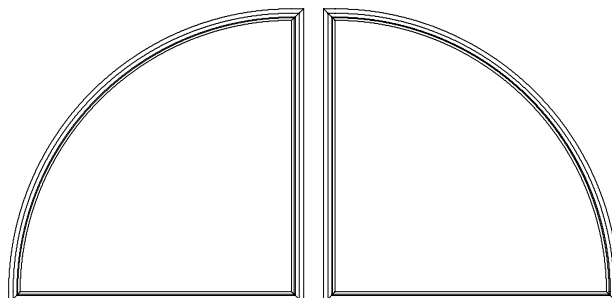

PQR7272

**ELEVATION SYMBOL LEGEND:**

VALUES IN ( ) ARE IN MILLIMETER CONVERSIONS

## INDICATES DESIGN PRESSURE (DP) RATING WITH STANDARD GLAZING

Note: Elevations shown DO NOT have exterior trim. Subtract 1/2"(12.7) from M.O.(Masonry Opening) for Unit Sizes. Masonry openings above include Sill Nose, see Trim Options page for Sill Nose specifications. For other Trim Options refer to the Unit Sizing, Rough Opening & Masonry Openings page.

SCALE: 1/4" = 1'

### HALF ROUND

**UNIT SIZE** 25 3/4"(654)  
**ROUGH OPENING** 24"(610)  
**FRAME SIZE** 23 1/2"(597)  
**DAYLIGHT OPENING** 19 7/8"(505)

13 3/4"(349)  
 12"(305)  
 11 1/2"(292)  
 7 7/8"(200)



PHR2412

**UNIT SIZE** 27 3/4"(705)  
**ROUGH OPENING** 26"(660)  
**FRAME SIZE** 25 1/2"(648)  
**DAYLIGHT OPENING** 21 7/8"(556)



PHR2613

**UNIT SIZE** 31 3/4"(806)  
**ROUGH OPENING** 30"(762)  
**FRAME SIZE** 29 1/2"(749)  
**DAYLIGHT OPENING** 25 7/8"(657)



PHR3015

**UNIT SIZE** 33 3/4"(857)  
**ROUGH OPENING** 32"(813)  
**FRAME SIZE** 31 1/2"(800)  
**DAYLIGHT OPENING** 27 7/8"(708)



PHR3216

**UNIT SIZE** 35 3/4"(908)  
**ROUGH OPENING** 34"(864)  
**FRAME SIZE** 33 1/2"(851)  
**DAYLIGHT OPENING** 29 7/8"(759)



PHR3417

**UNIT SIZE** 37 3/4"(959)  
**ROUGH OPENING** 36"(914)  
**FRAME SIZE** 35 1/2"(902)  
**DAYLIGHT OPENING** 31 7/8"(810)

19 3/4"(502)  
 18"(457)  
 17 1/2"(445)  
 13 7/8"(352)



PHR3618

**UNIT SIZE** 39 3/4"(1010)  
**ROUGH OPENING** 38"(965)  
**FRAME SIZE** 37 1/2"(953)  
**DAYLIGHT OPENING** 33 7/8"(860)

20 3/4"(527)  
 19"(483)  
 18 1/2"(470)  
 14 7/8"(378)



PHR3819

**UNIT SIZE** 43 3/4"(1111)  
**ROUGH OPENING** 42"(1067)  
**FRAME SIZE** 41 1/2"(1054)  
**DAYLIGHT OPENING** 37 7/8"(962)

22 3/4"(578)  
 21"(533)  
 20 1/2"(521)  
 16 7/8"(427)



PHR4221

**UNIT SIZE** 45 3/4"(1162)  
**ROUGH OPENING** 44"(1118)  
**FRAME SIZE** 43 1/2"(1105)  
**DAYLIGHT OPENING** 39 7/8"(1013)

23 3/4"(603)  
 22"(559)  
 21 1/2"(546)  
 17 7/8"(454)



PHR4422

**UNIT SIZE** 49 3/4"(1264)  
**ROUGH OPENING** 48"(1219)  
**FRAME SIZE** 47 1/2"(1207)  
**DAYLIGHT OPENING** 43 7/8"(1114)

25 3/4"(654)  
 24"(610)  
 23 1/2"(597)  
 19 7/8"(505)

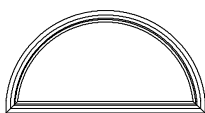

PHR4824

**UNIT SIZE** 53 3/4"(1365)  
**ROUGH OPENING** 52"(1321)  
**FRAME SIZE** 51 1/2"(1308)  
**DAYLIGHT OPENING** 47 7/8"(1216)

27 3/4"(705)  
 26"(660)  
 25 1/2"(648)  
 21 7/8"(556)

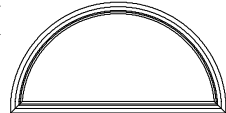

PHR5226

**UNIT SIZE** 55 3/4"(1416)  
**ROUGH OPENING** 54"(1372)  
**FRAME SIZE** 53 1/2"(1359)  
**DAYLIGHT OPENING** 49 7/8"(1267)

28 3/4"(730)  
 27"(686)  
 26 1/2"(673)  
 22 7/8"(581)



PHR5427

**UNIT SIZE** 61 3/4"(1568)  
**ROUGH OPENING** 60"(1524)  
**FRAME SIZE** 59 1/2"(1511)  
**DAYLIGHT OPENING** 55 7/8"(1419)

31 3/4"(806)  
 30"(762)  
 29 1/2"(749)  
 25 7/8"(657)



PHR6030

**UNIT SIZE** 65 3/4"(1670)  
**ROUGH OPENING** 64"(1626)  
**FRAME SIZE** 63 1/2"(1613)  
**DAYLIGHT OPENING** 59 7/8"(1581)

33 3/4"(857)  
 32"(813)  
 31 1/2"(800)  
 27 7/8"(708)

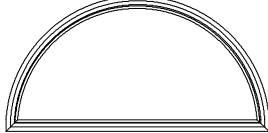

PHR6432

**UNIT SIZE** 67 3/4"(1721)  
**ROUGH OPENING** 66"(1676)  
**FRAME SIZE** 65 1/2"(1664)  
**DAYLIGHT OPENING** 61 7/8"(1572)

34 3/4"(883)  
 33"(838)  
 32 1/2"(826)  
 28 7/8"(733)



PHR6633

**UNIT SIZE** 69 3/4"(1772)  
**ROUGH OPENING** 68"(1727)  
**FRAME SIZE** 67 1/2"(1715)  
**DAYLIGHT OPENING** 63 7/8"(1622)

35 3/4"(908)  
 34"(864)  
 33 1/2"(851)  
 29 7/8"(759)



PHR6834

**UNIT SIZE** 73 3/4"(1873)  
**ROUGH OPENING** 72"(1829)  
**FRAME SIZE** 71 1/2"(1816)  
**DAYLIGHT OPENING** 67 7/8"(1724)

37 3/4"(959)  
 36"(914)  
 35 1/2"(902)  
 31 7/8"(810)

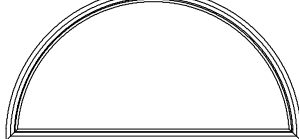

PHR7236

**ELEVATION SYMBOL LEGEND:**  
 VALUES IN ( ) ARE IN MILLIMETER CONVERSIONS  
 ## INDICATES DESIGN PRESSURE (DP) RATING WITH STANDARD GLAZING

Note: Elevations shown DO NOT have exterior trim. Subtract 1/2"(12.7) from M.O.(Masonry Opening) for Unit Sizes. Masonry openings above include Sill Nose, see Trim Options page for Sill Nose specifications. For other Trim Options refer to the Unit Sizing, Rough Opening & Masonry Openings page.

SCALE: 1/4" = 1'

#### FULL ROUND

**UNIT SIZE**  
**ROUGH OPENING**  
**FRAME SIZE**  
**DAYLIGHT OPENING**

31 3/4" (806)  
30" (762)  
29 1/2" (749)  
25 7/8" (657)

31 3/4" (806)  
30" (762)  
29 1/2" (749)  
25 7/8" (657)

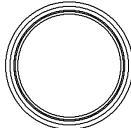

PFR30

35 3/4" (908)  
34" (864)  
33 1/2" (851)  
29 7/8" (759)

35 3/4" (908)  
34" (864)  
33 1/2" (851)  
29 7/8" (759)

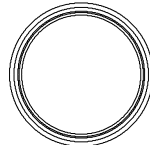

PFR34

37 3/4" (959)  
36" (914)  
35 1/2" (902)  
31 7/8" (810)

37 3/4" (959)  
36" (914)  
35 1/2" (902)  
31 7/8" (810)

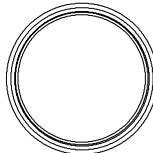

PFR36

39 3/4" (1010)  
38" (965)  
37 1/2" (953)  
33 7/8" (860)

39 3/4" (1010)  
38" (965)  
37 1/2" (953)  
33 7/8" (860)

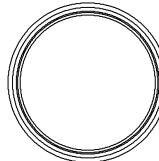

PFR38

43 3/4" (1111)  
42" (1067)  
41 1/2" (1054)  
37 7/8" (962)

43 3/4" (1111)  
42" (1067)  
41 1/2" (1054)  
37 7/8" (962)

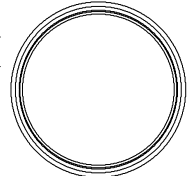

PFR42

**UNIT SIZE**  
**ROUGH OPENING**  
**FRAME SIZE**  
**DAYLIGHT OPENING**

49 3/4" (1264)  
48" (1219)  
47 1/2" (1207)  
43 7/8" (1114)

49 3/4" (1264)  
48" (1219)  
47 1/2" (1207)  
43 7/8" (1114)

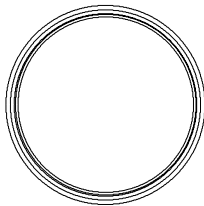

PFR48

55 3/4" (1416)  
54" (1372)  
53 1/2" (1359)  
49 7/8" (1267)

55 3/4" (1416)  
54" (1372)  
53 1/2" (1359)  
49 7/8" (1267)

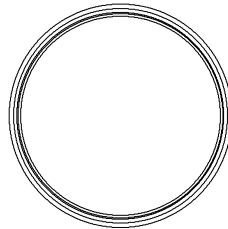

PFR54

61 3/4" (1568)  
60" (1524)  
59 1/2" (1511)  
55 7/8" (1419)

61 3/4" (1568)  
60" (1524)  
59 1/2" (1511)  
55 7/8" (1419)

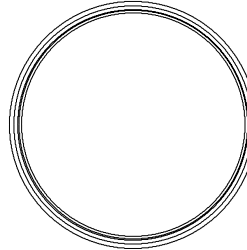

PFR60

**UNIT SIZE**  
**ROUGH OPENING**  
**FRAME SIZE**  
**DAYLIGHT OPENING**

67 3/4" (1721)  
66" (1676)  
65 1/2" (1664)  
61 7/8" (1572)

67 3/4" (1721)  
66" (1676)  
65 1/2" (1664)  
61 7/8" (1572)

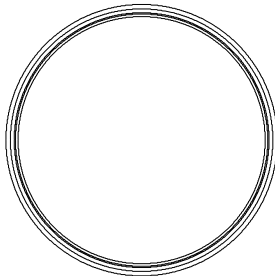

PFR66

73 3/4" (1873)  
72" (1829)  
71 1/2" (1816)  
67 7/8" (1724)

73 3/4" (1873)  
72" (1829)  
71 1/2" (1816)  
67 7/8" (1724)

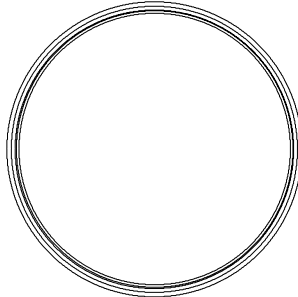

PFR72

**ELEVATION SYMBOL LEGEND:**

VALUES IN ( ) ARE IN MILLIMETER CONVERSIONS

## INDICATES DESIGN PRESSURE (DP) RATING WITH STANDARD GLAZING

Note: Elevations shown DO NOT have exterior trim. Subtract 1/2" (12.7) from M.O. (Masonry Opening) for Unit Sizes. Masonry openings above include Sill Nose, see Trim Options page for Sill Nose specifications. For other Trim Options refer to the Unit Sizing, Rough Opening & Masonry Openings page.

SCALE: 1/4" = 1'

#### QUARTER CIRCLE SEGMENT

**UNIT SIZE** 31 3/4"(806)  
**ROUGH OPENING** 30"(762)  
**FRAME SIZE** 29 1/2"(749)  
**DAYLIGHT OPENING** 25 7/8"(657)

25 3/4"(654)  
 24"(610)  
 23 1/2"(597)  
 19 7/8"(505)

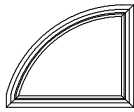

PQE3024

**UNIT SIZE** 37 3/4"(959)  
**ROUGH OPENING** 36"(914)  
**FRAME SIZE** 35 1/2"(902)  
**DAYLIGHT OPENING** 31 7/8"(810)

31 3/4"(806)  
 30"(762)  
 29 1/2"(749)  
 25 7/8"(657)

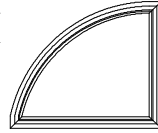

PQE3630

37 3/4"(959)  
 36"(914)  
 35 1/2"(902)  
 31 7/8"(810)

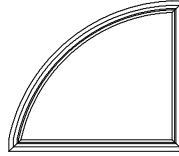

PQE4236

43 3/4"(1111)  
 42"(1067)  
 41 1/2"(1054)  
 37 7/8"(962)

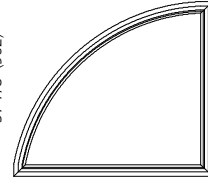

PQE4842

**UNIT SIZE** 55 3/4"(1416)  
**ROUGH OPENING** 54"(1372)  
**FRAME SIZE** 53 1/2"(1359)  
**DAYLIGHT OPENING** 49 7/8"(1267)

49 3/4"(1264)  
 48"(1219)  
 47 1/2"(1207)  
 43 7/8"(1114)

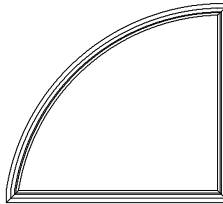

PQE5448

55 3/4"(1416)  
 54"(1372)  
 53 1/2"(1359)  
 49 7/8"(1267)

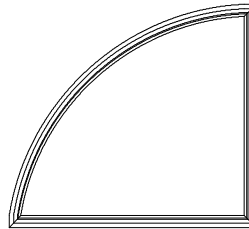

PQE6054

61 3/4"(1568)  
 60"(1524)  
 59 1/2"(1511)  
 55 7/8"(1419)

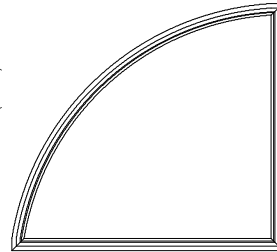

PQE6660

**UNIT SIZE** 73 3/4"(1873)  
**ROUGH OPENING** 72"(1829)  
**FRAME SIZE** 71 1/2"(1816)  
**DAYLIGHT OPENING** 67 7/8"(1724)

67 3/4"(1721)  
 66"(1676)  
 65 1/2"(1664)  
 61 7/8"(1572)

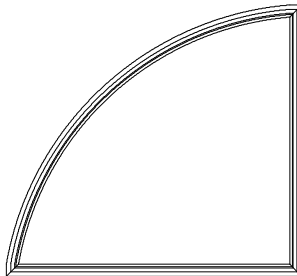

PQE7266

**ELEVATION SYMBOL LEGEND:**  
 VALUES IN ( ) ARE IN MILLIMETER CONVERSIONS  
 ## INDICATES DESIGN PRESSURE (DP) RATING WITH STANDARD GLAZING

Note: Elevations shown DO NOT have exterior trim. Subtract 1/2"(12.7) from M.O.(Masonry Opening) for Unit Sizes. Masonry openings above include Sill Nose, see Trim Options page for Sill Nose specifications. For other Trim Options refer to the Unit Sizing, Rough Opening & Masonry Openings page.

SCALE: 1/4" = 1'

#### CIRCLE SEGMENT

UNIT SIZE  
ROUGH OPENING  
FRAME SIZE  
DAYLIGHT OPENING

31 3/4" (806)  
30" (762)  
29 1/2" (749)  
25 7/8" (657)

37 3/4" (959)  
36" (914)  
35 1/2" (902)  
31 7/8" (810)

13 3/4" (349)  
12" (305)  
11 1/2" (292)  
7 7/8" (200)



PEY3012



PEY3612

UNIT SIZE  
ROUGH OPENING  
FRAME SIZE  
DAYLIGHT OPENING

43 3/4" (1111)  
42" (1067)  
41 1/2" (1054)  
37 7/8" (962)

49 3/4" (1264)  
48" (1219)  
47 1/2" (1207)  
43 7/8" (1114)

19 3/4" (502)  
18" (457)  
17 1/2" (445)  
13 7/8" (352)



PEY4218



PEY4818

UNIT SIZE  
ROUGH OPENING  
FRAME SIZE  
DAYLIGHT OPENING

55 3/4" (1416)  
54" (1372)  
53 1/2" (1359)  
49 7/8" (1267)

61 3/4" (1568)  
60" (1524)  
59 1/2" (1511)  
55 7/8" (1419)

25 3/4" (654)  
24" (610)  
23 1/2" (597)  
19 7/8" (505)



PEY5424

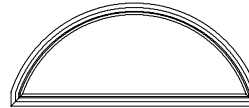

PEY6024

UNIT SIZE  
ROUGH OPENING  
FRAME SIZE  
DAYLIGHT OPENING

67 3/4" (1721)  
66" (1676)  
65 1/2" (1664)  
61 7/8" (1572)

73 3/4" (1873)  
72" (1829)  
71 1/2" (1816)  
67 7/8" (1724)

31 3/4" (806)  
30" (762)  
29 1/2" (749)  
25 7/8" (657)

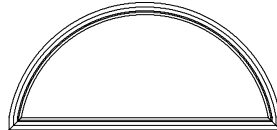

PEY6630



PEY7230

**ELEVATION SYMBOL LEGEND:**  
VALUES IN ( ) ARE IN MILLIMETER CONVERSIONS  
## INDICATES DESIGN PRESSURE (DP) RATING WITH STANDARD GLAZING

Note: Elevations shown DO NOT have exterior trim. Subtract 1/2" (12.7) from M.O. (Masonry Opening) for Unit Sizes. Masonry openings above include Sill Nose, see Trim Options page for Sill Nose specifications. For other Trim Options refer to the Unit Sizing, Rough Opening & Masonry Openings page.

SCALE: 1/4" = 1'

#### EXTENDED QUARTER ROUND

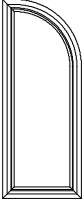
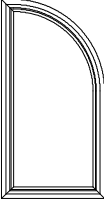
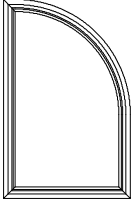
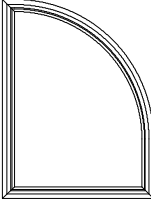
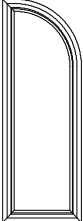
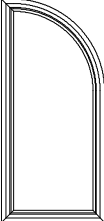
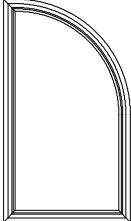
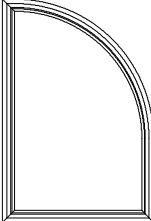
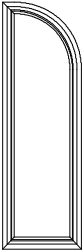
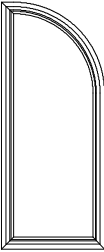
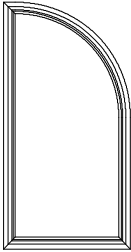
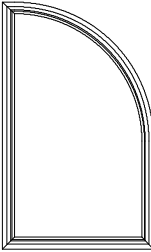
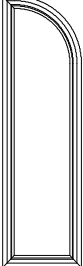
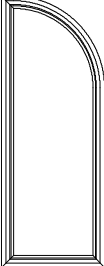
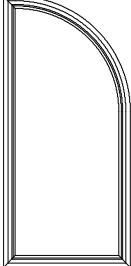
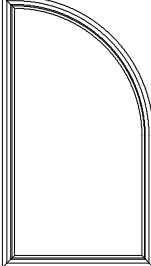
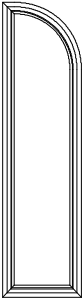
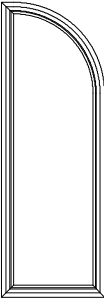
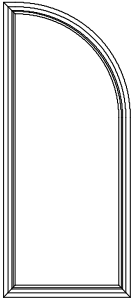
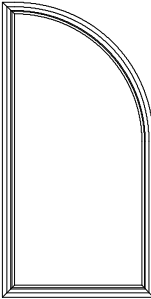
UNIT SIZE ROUGH OPENING FRAME SIZE DAYLIGHT OPENING	19 3/4"(502) 18"(457) 17 1/2"(445) 13 7/8"(352)	25 3/4"(654) 24"(610) 23 1/2"(597) 19 7/8"(505)	31 3/4"(806) 30"(762) 29 1/2"(749) 25 7/8"(657)	37 3/4"(959) 36"(914) 35 1/2"(902) 31 7/8"(810)
49 3/4"(1264) 48"(1219) 47 1/2"(1207) 43 7/8"(1114)				
	PQT1848	PQT2448	PQT3048	PQT3648
55 3/4"(1416) 54"(1372) 53 1/2"(1359) 49 7/8"(1267)				
	PQT1854	PQT2454	PQT3054	PQT3654
61 3/4"(1568) 60"(1524) 59 1/2"(1511) 55 7/8"(1419)				
	PQT1860	PQT2460	PQT3060	PQT3660
67 3/4"(1721) 66"(1676) 65 1/2"(1664) 61 7/8"(1572)				
	PQT1866	PQT2466	PQT3066	PQT3666
73 3/4"(1873) 72"(1829) 71 1/2"(1816) 67 7/8"(1724)				
	PQT1872	PQT2472	PQT3072	PQT3672

**ELEVATION SYMBOL LEGEND:**  
 VALUES IN ( ) ARE IN MILLIMETER CONVERSIONS  
 ## INDICATES DESIGN PRESSURE (DP) RATING WITH STANDARD GLAZING

Note: Elevations shown DO NOT have exterior trim. Subtract 1/2"(12.7) from M.O.(Masonry Opening) for Unit Sizes. Masonry openings above include Sill Nose, see Trim Options page for Sill Nose specifications. For other Trim Options refer to the Unit Sizing, Rough Opening & Masonry Openings page.

SCALE: 1/4" = 1'

**EXTENDED HALF ROUND**

**UNIT SIZE**  
**ROUGH OPENING**  
**FRAME SIZE**  
**DAYLIGHT OPENING**

25 3/4" (654)  
24" (610)  
23 1/2" (597)  
19 7/8" (505)

31 3/4" (806)  
30" (762)  
29 1/2" (749)  
25 7/8" (657)

37 3/4" (959)  
36" (914)  
35 1/2" (902)  
31 7/8" (810)

43 3/4" (1111)  
42" (1067)  
41 1/2" (1054)  
37 7/8" (962)

49 3/4" (1264)  
48" (1219)  
47 1/2" (1207)  
43 7/8" (1114)

37 3/4" (959)  
36" (914)  
35 1/2" (902)  
31 7/8" (810)

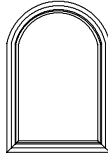

PSL2436

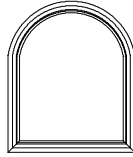

PSL3036

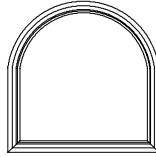

PSL3636

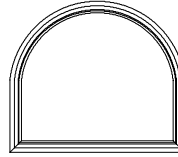

PSL4236

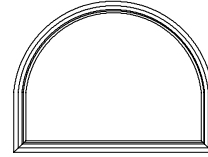

PSL4836

43 3/4" (1111)  
42" (1067)  
41 1/2" (1054)  
37 7/8" (962)

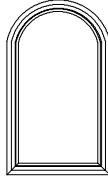

PSL2442

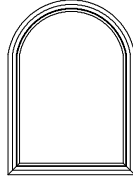

PSL3042

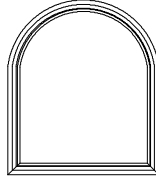

PSL3642

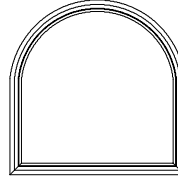

PSL4242

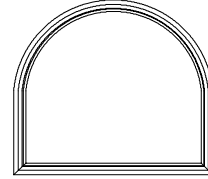

PSL4842

49 3/4" (1264)  
48" (1219)  
47 1/2" (1207)  
43 7/8" (1114)

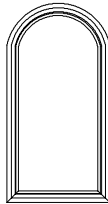

PSL2448

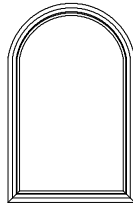

PSL3048

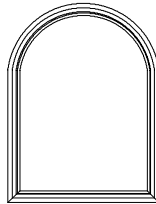

PSL3648

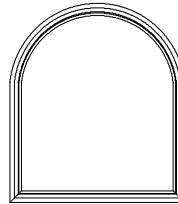

PSL4248

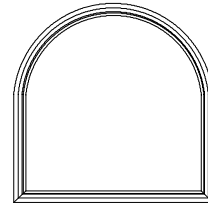

PSL4848

55 3/4" (1416)  
54" (1372)  
53 1/2" (1359)  
49 7/8" (1267)

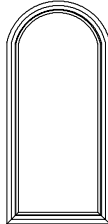

PSL2454

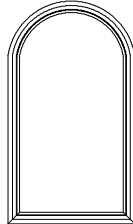

PSL3054

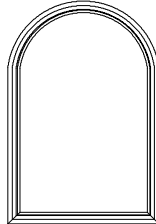

PSL3654

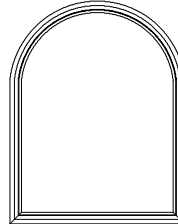

PSL4254

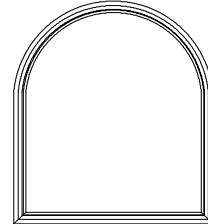

PSL4854

61 3/4" (1568)  
60" (1524)  
59 1/2" (1511)  
55 7/8" (1419)

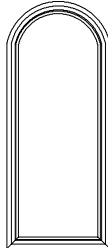

PSL2460

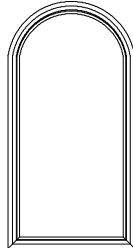

PSL3060

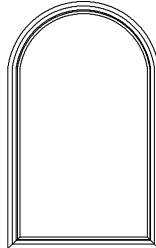

PSL3660

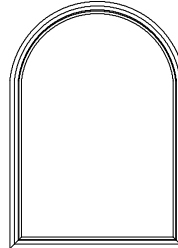

PSL4260

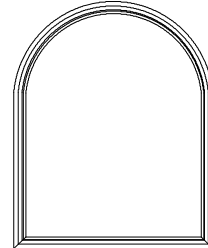

PSL4860

67 3/4" (1721)  
66" (1676)  
65 1/2" (1664)  
61 7/8" (1572)

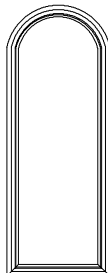

PSL2466

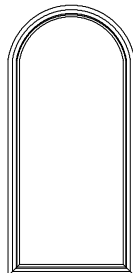

PSL3066

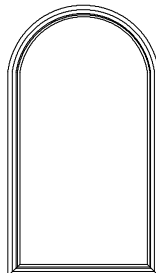

PSL3666

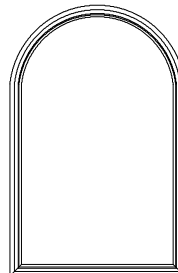

PSL4266

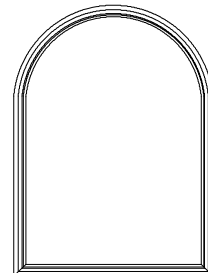

PSL4866

**ELEVATION SYMBOL LEGEND:**  
VALUES IN ( ) ARE IN MILLIMETER CONVERSIONS  
## INDICATES DESIGN PRESSURE (DP) RATING WITH STANDARD GLAZING

Note: Elevations shown DO NOT have exterior trim. Subtract 1/2" (12.7) from M.O. (Masonry Opening) for Unit Sizes. Masonry openings above include Sill Nose, see Trim Options page for Sill Nose specifications. For other Trim Options refer to the Unit Sizing, Rough Opening & Masonry Openings page.

SCALE: 1/4" = 1'



**EXTENDED HALF ROUND**

UNIT SIZE  
ROUGH OPENING  
FRAME SIZE  
DAYLIGHT OPENING

25 3/4" (654)	31 3/4" (806)	37 3/4" (959)	43 3/4" (1111)	49 3/4" (1264)
24" (610)	30" (762)	36" (914)	42" (1067)	48" (1219)
23 1/2" (597)	29 1/2" (749)	35 1/2" (902)	41 1/2" (1054)	47 1/2" (1207)
19 7/8" (505)	25 7/8" (657)	31 7/8" (810)	37 7/8" (962)	43 7/8" (1114)

73 3/4" (1873)  
72" (1829)  
71 1/2" (1816)  
67 7/8" (1724)

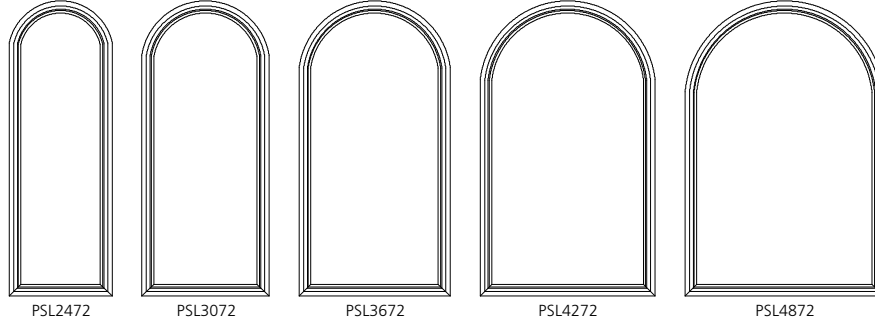

**ELEVATION SYMBOL LEGEND:**

VALUES IN ( ) ARE IN MILLIMETER CONVERSIONS

## INDICATES DESIGN PRESSURE (DP) RATING WITH STANDARD GLAZING

Note: Elevations shown DO NOT have exterior trim. Subtract 1/2"(12.7) from M.O.(Masonry Opening) for Unit Sizes. Masonry openings above include Sill Nose, see Trim Options page for Sill Nose specifications. For other Trim Options refer to the Unit Sizing, Rough Opening & Masonry Openings page.

SCALE: 1/4" = 1'

### EXTENDED QUARTER SEGMENT

**UNIT SIZE**  
**ROUGH OPENING**  
**FRAME SIZE**  
**DAYLIGHT OPENING**

	25 3/4" (654) 24" (610) 23 1/2" (597) 19 7/8" (505)	31 3/4" (806) 30" (762) 29 1/2" (749) 25 7/8" (657)	37 3/4" (959) 36" (914) 35 1/2" (902) 31 7/8" (810)	43 3/4" (1111) 42" (1067) 41 1/2" (1054) 37 7/8" (962)	49 3/4" (1264) 48" (1219) 47 1/2" (1207) 43 7/8" (1114)	55 3/4" (1416) 54" (1372) 53 1/2" (1359) 49 7/8" (1267)
25 3/4" (654) 24" (610) 23 1/2" (597) 19 7/8" (505)						
	PQP2424	PQP3024	PQP3624	PQP4224	PQP4824	PQP5424
31 3/4" (806) 30" (762) 29 1/2" (749) 25 7/8" (657)						
	PQP2430	PQP3030	PQP3630	PQP4230	PQP4830	PQP5430
37 3/4" (959) 36" (914) 35 1/2" (902) 31 7/8" (810)						
	PQP2436	PQP3036	PQP3636	PQP4236	PQP4836	PQP5436
43 3/4" (1111) 42" (1067) 41 1/2" (1054) 37 7/8" (962)						
	PQP2442	PQP3042	PQP3642	PQP4242	PQP4842	PQP5442
49 3/4" (1264) 48" (1219) 47 1/2" (1207) 43 7/8" (1114)						
	PQP2448	PQP3048	PQP3648	PQP4248	PQP4848	PQP5448
55 3/4" (1416) 54" (1372) 53 1/2" (1359) 49 7/8" (1267)						
	PQP2454	PQP3054	PQP3654	PQP4254	PQP4854	PQP5454
61 3/4" (1568) 60" (1524) 59 1/2" (1511) 55 7/8" (1419)						
	PQP2460	PQP3060	PQP3660	PQP4260	PQP4860	PQP5460

**ELEVATION SYMBOL LEGEND:**

VALUES IN ( ) ARE IN MILLIMETER CONVERSIONS

## INDICATES DESIGN PRESSURE (DP) RATING WITH STANDARD GLAZING

Note: Elevations shown DO NOT have exterior trim. Subtract 1/2" (12.7) from M.O. (Masonry Opening) for Unit Sizes. Masonry openings above include Sill Nose, see Trim Options page for Sill Nose specifications. For other Trim Options refer to the Unit Sizing, Rough Opening & Masonry Openings page.

SCALE: 1/4" = 1'

#### EXTENDED QUARTER SEGMENT

UNIT SIZE  
ROUGH OPENING  
FRAME SIZE  
DAYLIGHT OPENING

25 3/4"(654)  
24"(610)  
23 1/2"(597)  
19 7/8"(505)

31 3/4"(806)  
30"(762)  
29 1/2"(749)  
25 7/8"(657)

37 3/4"(959)  
36"(914)  
35 1/2"(902)  
31 7/8"(810)

43 3/4"(1111)  
42"(1067)  
41 1/2"(1054)  
37 7/8"(962)

49 3/4"(1264)  
48"(1219)  
47 1/2"(1207)  
43 7/8"(1114)

55 3/4"(1416)  
54"(1372)  
53 1/2"(1359)  
49 7/8"(1267)

67 3/4"(1721)  
66"(1676)  
65 1/2"(1664)  
61 7/8"(1572)

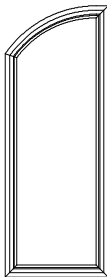

PQP2466

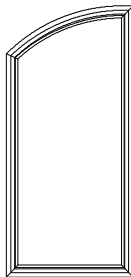

PQP3066

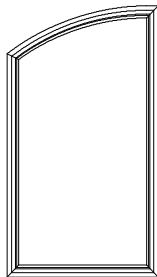

PQP3666

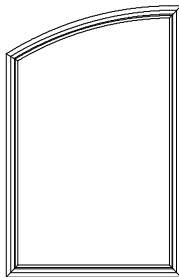

PQP4266

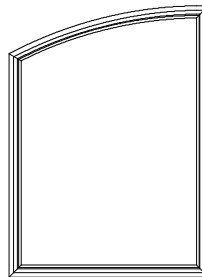

PQP4866

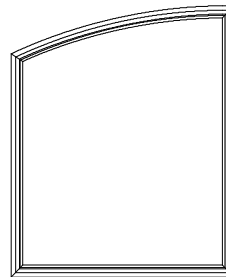

PQP5466

73 3/4"(1873)  
72"(1829)  
71 1/2"(1816)  
67 7/8"(1724)

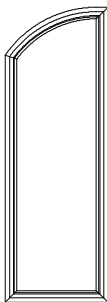

PQP2472

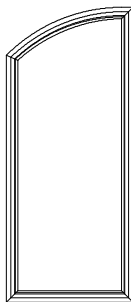

PQP3072

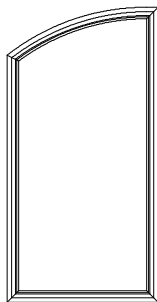

PQP3672

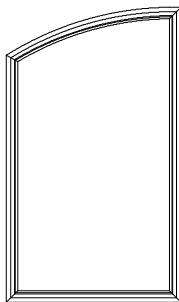

PQP4272

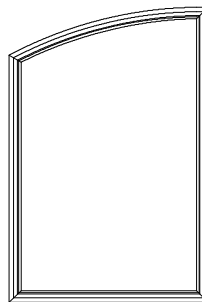

PQP4872

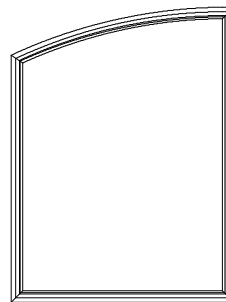

PQP5472

**ELEVATION SYMBOL LEGEND:**

VALUES IN ( ) ARE IN MILLIMETER CONVERSIONS

## INDICATES DESIGN PRESSURE (DP) RATING WITH STANDARD GLAZING

Note: Elevations shown DO NOT have exterior trim. Subtract 1/2"(12.7) from M.O.(Masonry Opening) for Unit Sizes. Masonry openings above include Sill Nose, see Trim Options page for Sill Nose specifications. For other Trim Options refer to the Unit Sizing, Rough Opening & Masonry Openings page.

SCALE: 1/4" = 1'

### EXTENDED QUARTER SEGMENT

UNIT SIZE  
ROUGH OPENING  
FRAME SIZE  
DAYLIGHT OPENING

61 3/4"(1568)  
60"(1524)  
59 1/2"(1511)  
55 7/8"(1419)

67 3/4"(1721)  
66"(1676)  
65 1/2"(1664)  
61 7/8"(1572)

73 3/4"(1873)  
72"(1829)  
71 1/2"(1816)  
67 7/8"(1724)

25 3/4"(654)  
24"(610)  
23 1/2"(597)  
19 7/8"(505)



PQP6024



PQP6624



PQP7224

31 3/4"(806)  
30"(762)  
29 1/2"(749)  
25 7/8"(657)

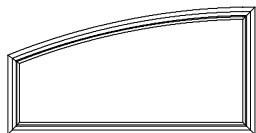

PQP6030

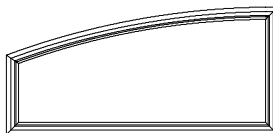

PQP6630

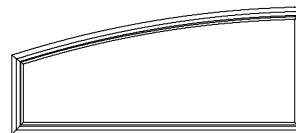

PQP7230

37 3/4"(959)  
36"(914)  
35 1/2"(902)  
31 7/8"(810)

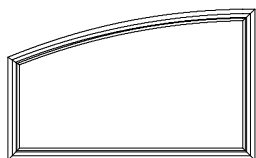

PQP6036

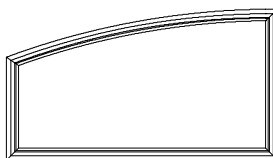

PQP6636

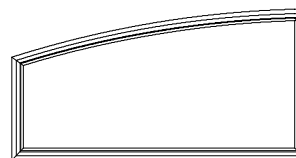

PQP7236

43 3/4"(1111)  
42"(1067)  
41 1/2"(1054)  
37 7/8"(962)

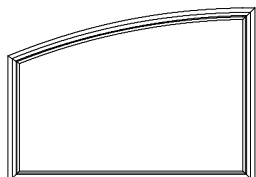

PQP6042

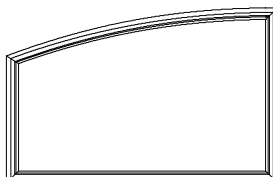

PQP6642

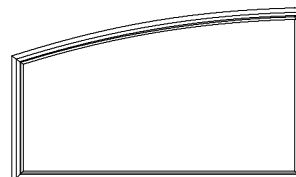

PQP7242

49 3/4"(1264)  
48"(1219)  
47 1/2"(1207)  
43 7/8"(1114)

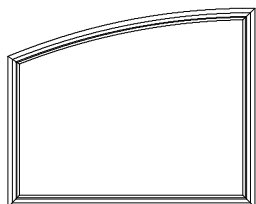

PQP6048

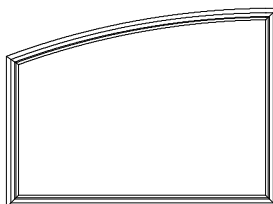

PQP6648

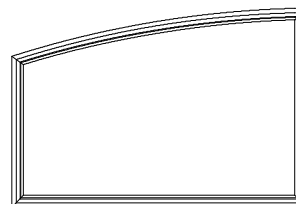

PQP7248

55 3/4"(1416)  
54"(1372)  
53 1/2"(1359)  
49 7/8"(1267)

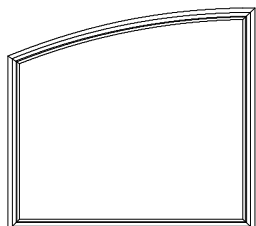

PQP6054

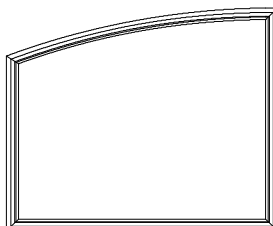

PQP6654

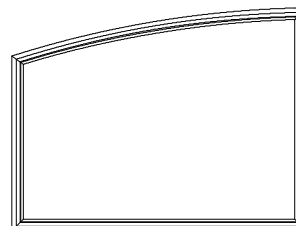

PQP7254

61 3/4"(1568)  
60"(1524)  
59 1/2"(1511)  
55 7/8"(1419)

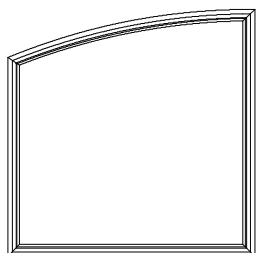

PQP6060

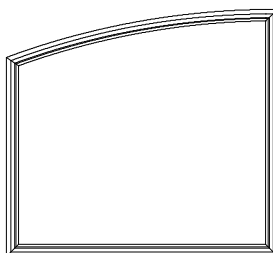

PQP6660

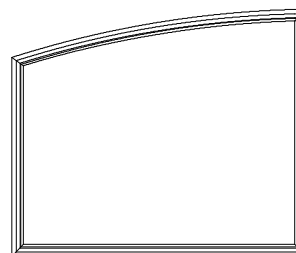

PQP7260

**ELEVATION SYMBOL LEGEND:**

VALUES IN ( ) ARE IN MILLIMETER CONVERSIONS

## INDICATES DESIGN PRESSURE (DP) RATING WITH STANDARD GLAZING

Note: Elevations shown DO NOT have exterior trim. Subtract 1/2"(12.7) from M.O.(Masonry Opening) for Unit Sizes. Masonry openings above include Sill Nose, see Trim Options page for Sill Nose specifications. For other Trim Options refer to the Unit Sizing, Rough Opening & Masonry Openings page.

SCALE: 1/4" = 1'

#### EXTENDED QUARTER SEGMENT

UNIT SIZE  
ROUGH OPENING  
FRAME SIZE  
DAYLIGHT OPENING

61 3/4"(1568)  
60"(1524)  
59 1/2"(1511)  
55 7/8"(1419)

67 3/4"(1721)  
66"(1676)  
65 1/2"(1664)  
61 7/8"(1572)

73 3/4"(1873)  
72"(1829)  
71 1/2"(1816)  
67 7/8"(1724)

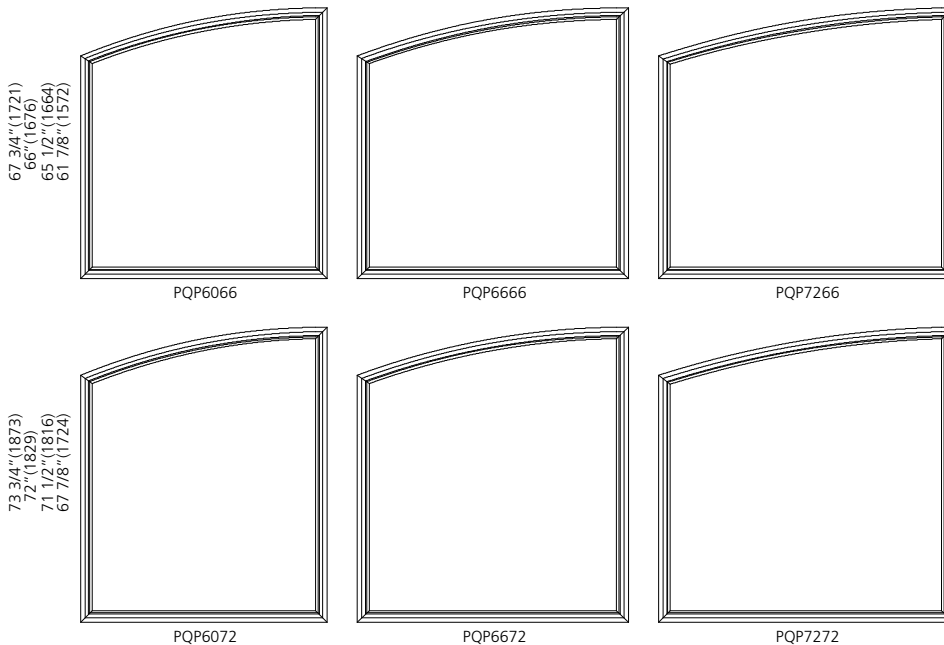

**ELEVATION SYMBOL LEGEND:**







VALUES IN ( ) ARE IN MILLIMETER CONVERSIONS

## INDICATES DESIGN PRESSURE (DP) RATING WITH STANDARD GLAZING

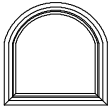
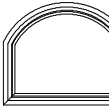
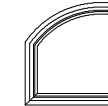
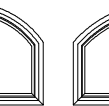
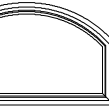
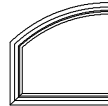
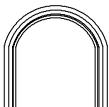
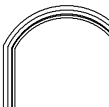
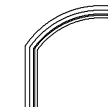
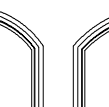
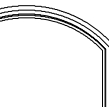
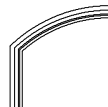
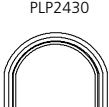
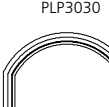
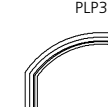
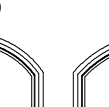
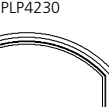
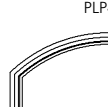
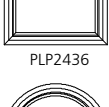
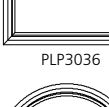
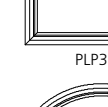
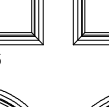
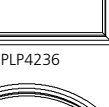
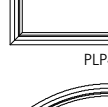
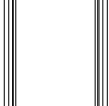
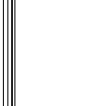
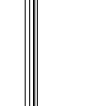
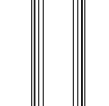
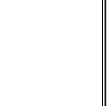
Note: Elevations shown DO NOT have exterior trim. Subtract 1/2"(12.7) from M.O.(Masonry Opening) for Unit Sizes. Masonry openings above include Sill Nose, see Trim Options page for Sill Nose specifications. For other Trim Options refer to the Unit Sizing, Rough Opening & Masonry Openings page.

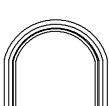
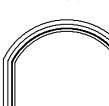
SCALE: 1/4" = 1'

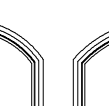
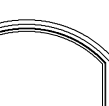
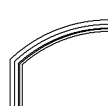
#### EXTENDED CIRCLE SEGMENT

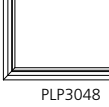
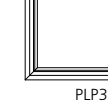
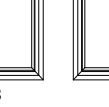
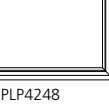
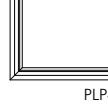
UNIT SIZE	25 3/4" (654)	31 3/4" (806)	37 3/4" (959)	43 3/4" (1111)	49 3/4" (1264)	55 3/4" (1416)
ROUGH OPENING	24" (610)	30" (762)	36" (914)	42" (1067)	48" (1219)	54" (1372)
FRAME SIZE	23 1/2" (597)	29 1/2" (749)	35 1/2" (902)	41 1/2" (1054)	47 1/2" (1207)	53 1/2" (1359)
DAYLIGHT OPENING	19 7/8" (505)	25 7/8" (657)	31 7/8" (810)	37 7/8" (962)	43 7/8" (1114)	49 7/8" (1267)
25 3/4" (654) 24" (610) 23 1/2" (597) 19 7/8" (505)	 PLP2424	 PLP3024	 PLP3624	 PLP4224	 PLP4824	 PLP5424
31 3/4" (806) 30" (762) 29 1/2" (749) 25 7/8" (657)	 PLP2430	 PLP3030	 PLP3630	 PLP4230	 PLP4830	 PLP5430
37 3/4" (959) 36" (914) 35 1/2" (902) 31 7/8" (810)	 PLP2436	 PLP3036	 PLP3636	 PLP4236	 PLP4836	 PLP5436
43 3/4" (1111) 42" (1067) 41 1/2" (1054) 37 7/8" (962)	 PLP2442	 PLP3042	 PLP3642	 PLP4242	 PLP4842	 PLP5442
49 3/4" (1264) 48" (1219) 47 1/2" (1207) 43 7/8" (1114)	 PLP2448	 PLP3048	 PLP3648	 PLP4248	 PLP4848	 PLP5448
55 3/4" (1416) 54" (1372) 53 1/2" (1359) 49 7/8" (1267)	 PLP2454	 PLP3054	 PLP3654	 PLP4254	 PLP4854	 PLP5454
61 3/4" (1568) 60" (1524) 59 1/2" (1511) 55 7/8" (1419)	 PLP2460	 PLP3060	 PLP3660	 PLP4260	 PLP4860	 PLP5460

**ELEVATION SYMBOL LEGEND:**  
 VALUES IN ( ) ARE IN MILLIMETER CONVERSIONS  
 ## INDICATES DESIGN PRESSURE (DP) RATING WITH STANDARD GLAZING

Note: Elevations shown DO NOT have exterior trim. Subtract 1/2" (12.7) from M.O. (Masonry Opening) for Unit Sizes. Masonry openings above include Sill Nose, see Trim Options page for Sill Nose specifications. For other Trim Options refer to the Unit Sizing, Rough Opening & Masonry Openings page.

SCALE: 1/4" = 1'

#### EXTENDED CIRCLE SEGMENT

UNIT SIZE	25 3/4" (654)	31 3/4" (806)	37 3/4" (959)	43 3/4" (1111)	49 3/4" (1264)	55 3/4" (1416)
ROUGH OPENING	24" (610)	30" (762)	36" (914)	42" (1067)	48" (1219)	54" (1372)
FRAME SIZE	23 1/2" (597)	29 1/2" (749)	35 1/2" (902)	41 1/2" (1054)	47 1/2" (1207)	53 1/2" (1359)
DAYLIGHT OPENING	19 7/8" (505)	25 7/8" (657)	31 7/8" (810)	37 7/8" (962)	43 7/8" (1114)	49 7/8" (1267)

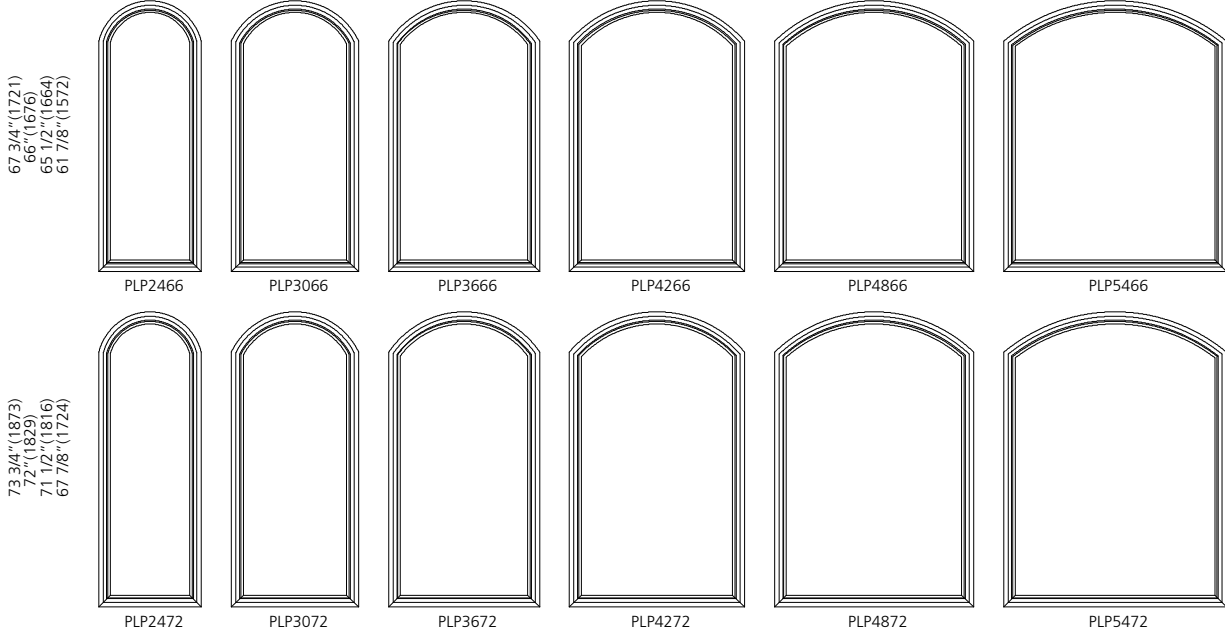

**ELEVATION SYMBOL LEGEND:**

VALUES IN ( ) ARE IN MILLIMETER CONVERSIONS

## INDICATES DESIGN PRESSURE (DP) RATING WITH STANDARD GLAZING

Note: Elevations shown DO NOT have exterior trim. Subtract 1/2" (12.7) from M.O. (Masonry Opening) for Unit Sizes. Masonry openings above include Sill Nose, see Trim Options page for Sill Nose specifications. For other Trim Options refer to the Unit Sizing, Rough Opening & Masonry Openings page.

SCALE: 1/4" = 1'

#### EXTENDED CIRCLE SEGMENT

UNIT SIZE  
ROUGH OPENING  
FRAME SIZE  
DAYLIGHT OPENING

61 3/4"(1568)  
60"(1524)  
59 1/2"(1511)  
55 7/8"(1419)

67 3/4"(1721)  
66"(1676)  
65 1/2"(1664)  
61 7/8"(1572)

73 3/4"(1873)  
72"(1829)  
71 1/2"(1816)  
67 7/8"(1724)

25 3/4"(654) 24"(610) 23 1/2"(597) 19 7/8"(505)			
31 3/4"(806) 30"(762) 29 1/2"(749) 25 7/8"(657)			
37 3/4"(959) 36"(914) 35 1/2"(902) 31 7/8"(810)			
43 3/4"(1111) 42"(1067) 41 1/2"(1054) 37 7/8"(962)			
49 3/4"(1264) 48"(1219) 47 1/2"(1207) 43 7/8"(1114)			
55 3/4"(1416) 54"(1372) 53 1/2"(1359) 49 7/8"(1267)			
61 3/4"(1568) 60"(1524) 59 1/2"(1511) 55 7/8"(1419)			

**ELEVATION SYMBOL LEGEND:**

VALUES IN () ARE IN MILLIMETER CONVERSIONS

## INDICATES DESIGN PRESSURE (DP) RATING WITH STANDARD GLAZING

Note: Elevations shown DO NOT have exterior trim. Subtract 1/2"(12.7) from M.O.(Masonry Opening) for Unit Sizes. Masonry openings above include Sill Nose, see Trim Options page for Sill Nose specifications. For other Trim Options refer to the Unit Sizing, Rough Opening & Masonry Openings page.

SCALE: 1/4" = 1'



**EXTENDED CIRCLE SEGMENT**

UNIT SIZE  
ROUGH OPENING  
FRAME SIZE  
DAYLIGHT OPENING

61 3/4"(1568)  
60"(1524)  
59 1/2"(1511)  
55 7/8"(1419)

67 3/4"(1721)  
66"(1676)  
65 1/2"(1664)  
61 7/8"(1572)

73 3/4"(1873)  
72"(1829)  
71 1/2"(1816)  
67 7/8"(1724)

67 3/4"(1721)  
66"(1676)  
65 1/2"(1664)  
61 7/8"(1572)

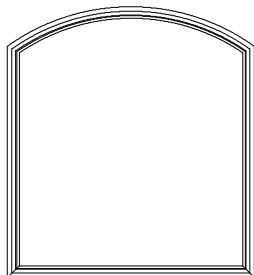

PLP6066

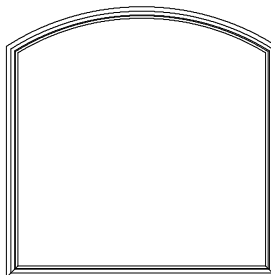

PLP6666

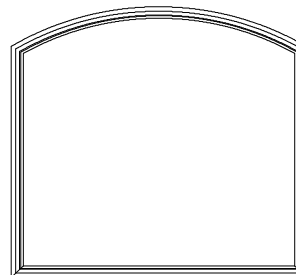

PLP7266

73 3/4"(1873)  
72"(1829)  
71 1/2"(1816)  
67 7/8"(1724)

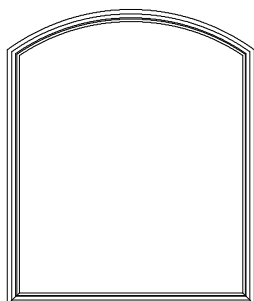

PLP6072

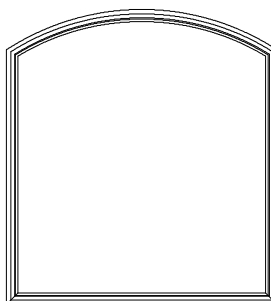

PLP6672

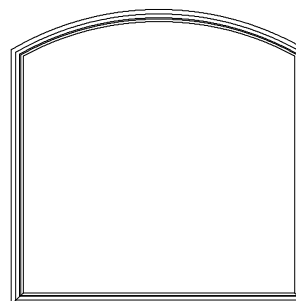

PLP7272

**ELEVATION SYMBOL LEGEND:**

VALUES IN ( ) ARE IN MILLIMETER CONVERSIONS

## INDICATES DESIGN PRESSURE (DP) RATING WITH STANDARD GLAZING

Note: Elevations shown DO NOT have exterior trim. Subtract 1/2"(12.7) from M.O.(Masonry Opening) for Unit Sizes. Masonry openings above include Sill Nose, see Trim Options page for Sill Nose specifications. For other Trim Options refer to the Unit Sizing, Rough Opening & Masonry Openings page.

SCALE: 1/4" = 1'

**SASH GLAZING OPTIONS: 4" SCALE**

**5/8" FLAT GBG BAR**

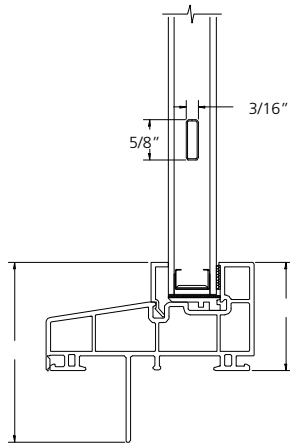

**1" CONTOUR GBG BAR**

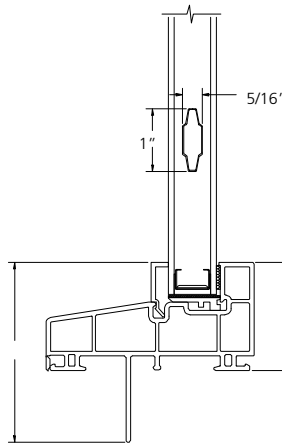

**7/8" SDL BAR**

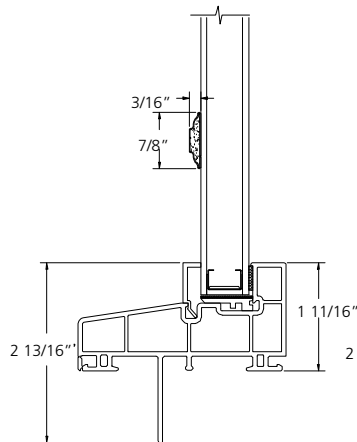

**1 1/8" SDL BAR**

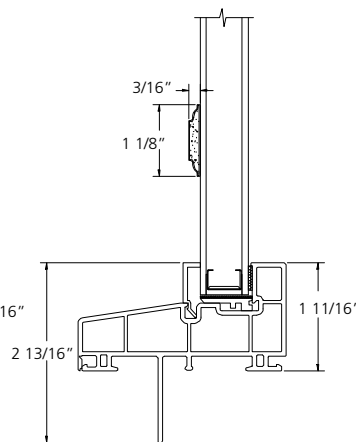

**1 3/8" SDL BAR**

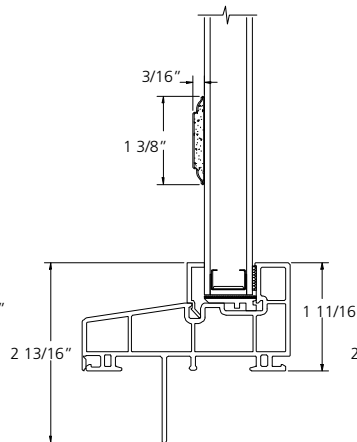

**2 1/8" SDL BAR**

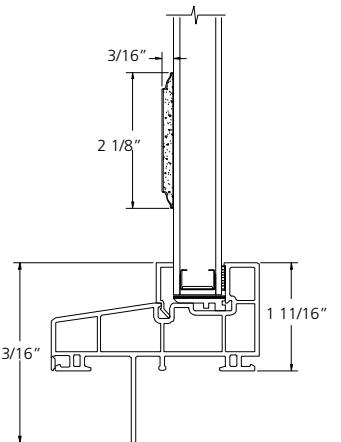

**STANDARD GLASS**

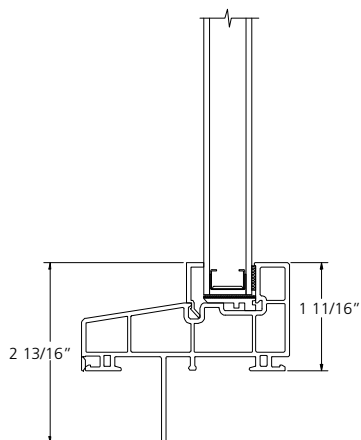

**3/16" GLASS**

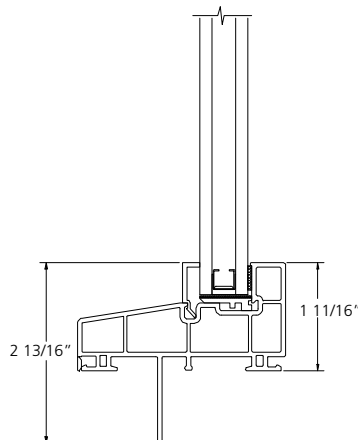

**1/4" GLASS**

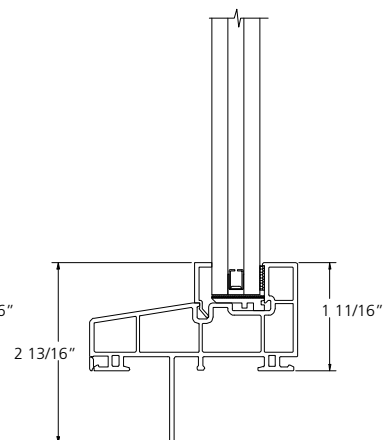

**GRILLE & SDL LITE PATTERNS**

**PICTURE**

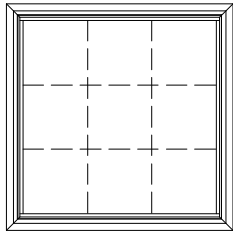

STANDARD

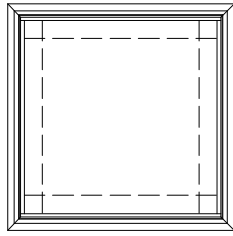

PRAIRIE

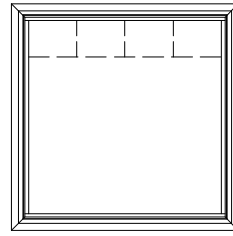

COLONIAL TOP 1/2

**FULL ROUND**

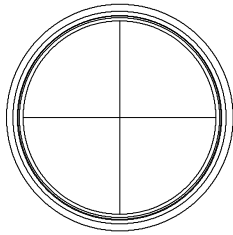

FR4

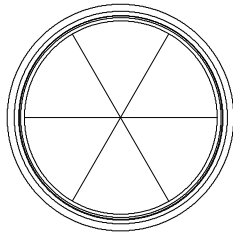

FR4

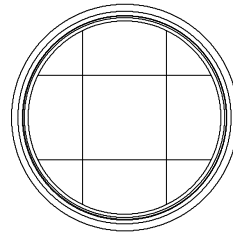

FR4

**GRILLE & SDL LITE PATTERNS**

**QUARTER ROUND**

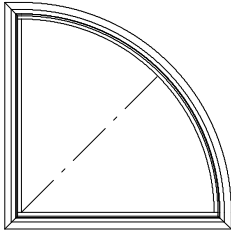

QR2

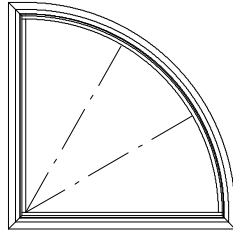

QR3

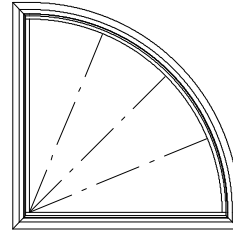

QR5

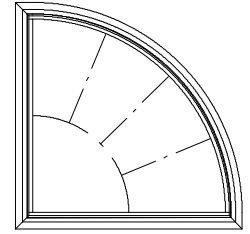

QR6

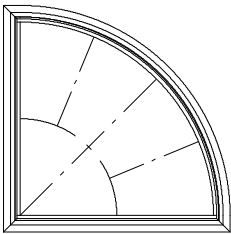

QR7

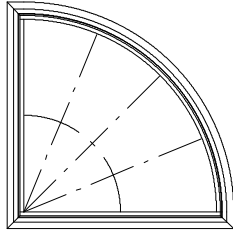

QR8

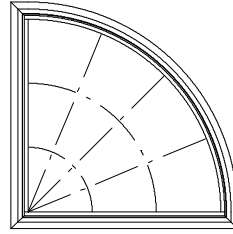

QR9

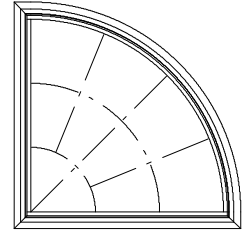

QR10

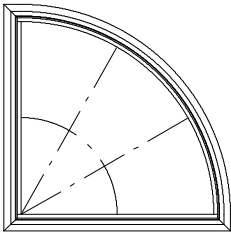

QR11

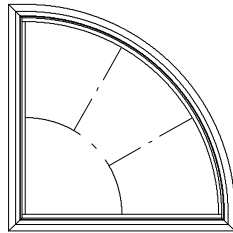

QR12

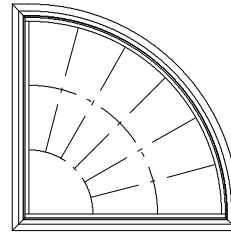

QR13

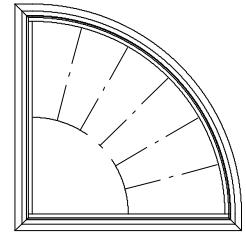

QR14

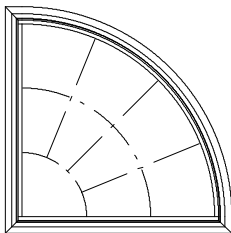

QR15

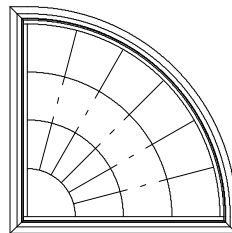

QR16

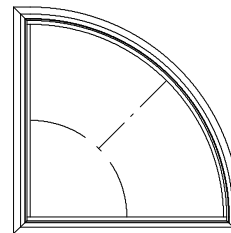

QR19

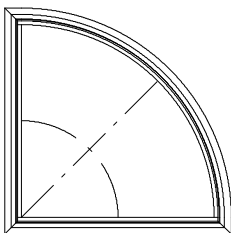

QR20

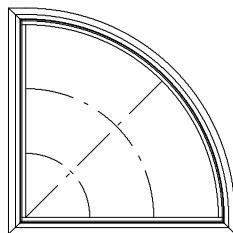

QR21

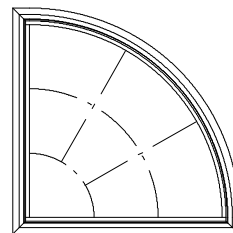

QR22

**GRILLE & SDL LITE PATTERNS**

**HALF ROUND**

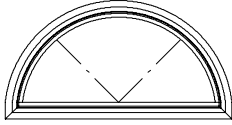

HR-3

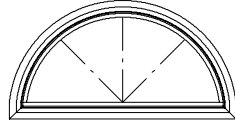

HR-5

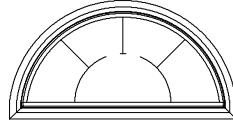

HR-6

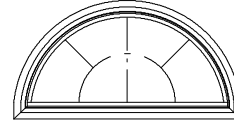

HR-7

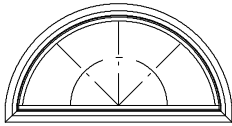

HR-8

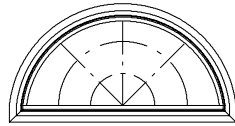

HR-9

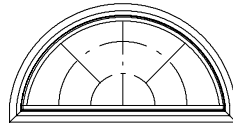

HR-10

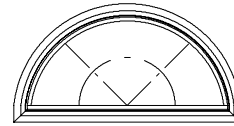

HR-11

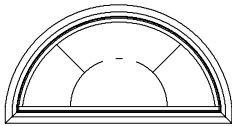

HR-12

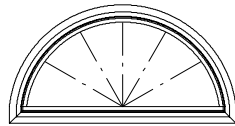

HR-13

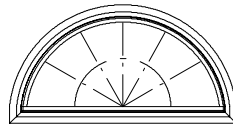

HR-14

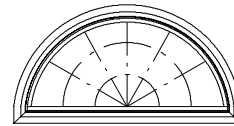

HR-15

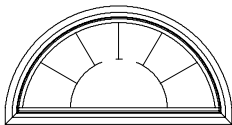

HR-16

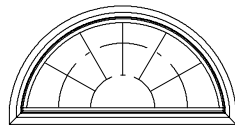

HR-17

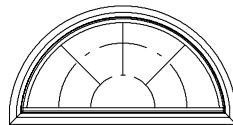

HR-18

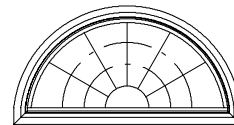

HR-19

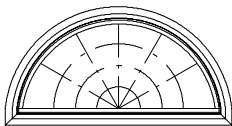

HR-20

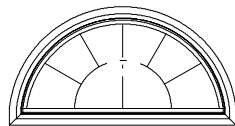

HR-23

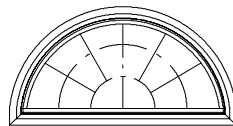

HR-24

**GRILLE & SDL LITE PATTERNS**

**EXTENDED QUARTER ROUND**

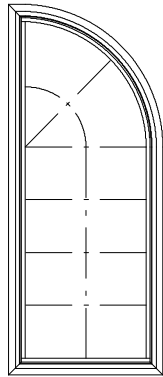

QT1

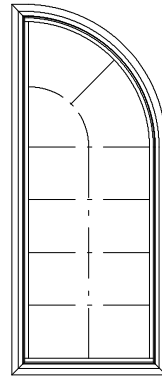

QT2

**EXTENDED HALF ROUND**

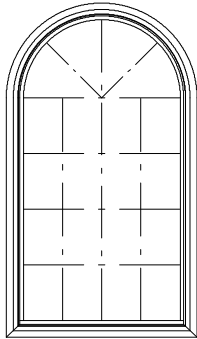

RT1

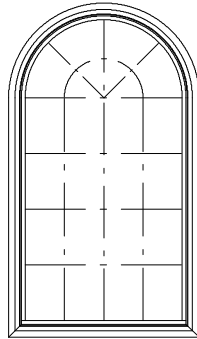

RT2

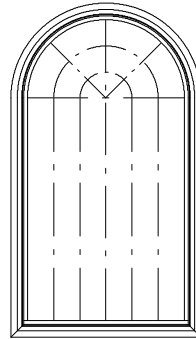

RT3

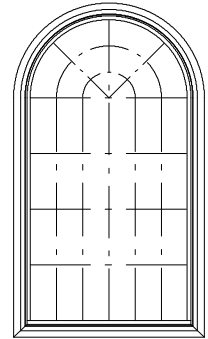

RT4

**EXTENDED CIRCLE SEGMENT**

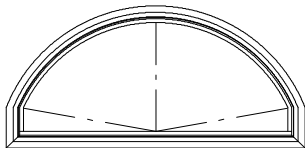

LP1

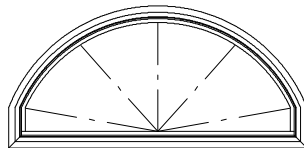

LP2

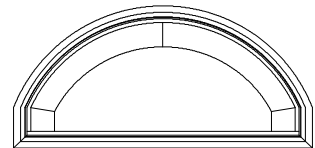

LP3

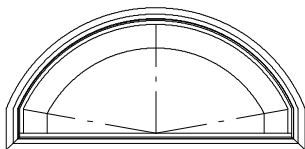

LP4

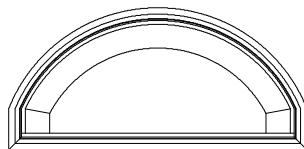

LP5

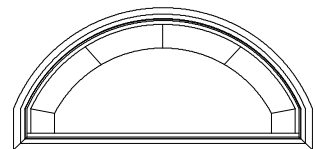

LP7

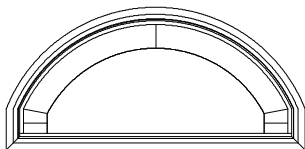

LP8

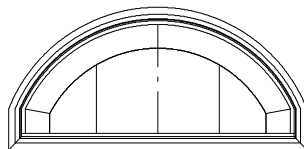

LP14

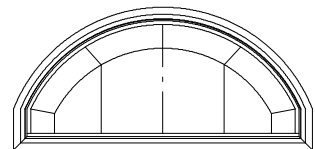

LP16

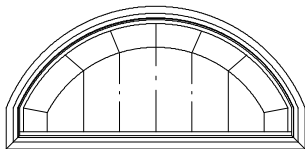

LP18

**PICTURE WINDOW  
NAILING FIN**

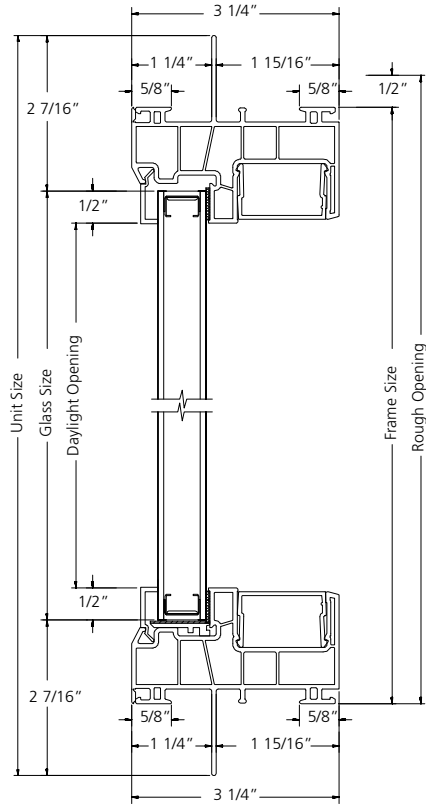

**VERTICAL SECTION**

SCALE: 4" = 1'

**PICTURE WINDOW  
NAILING FIN**

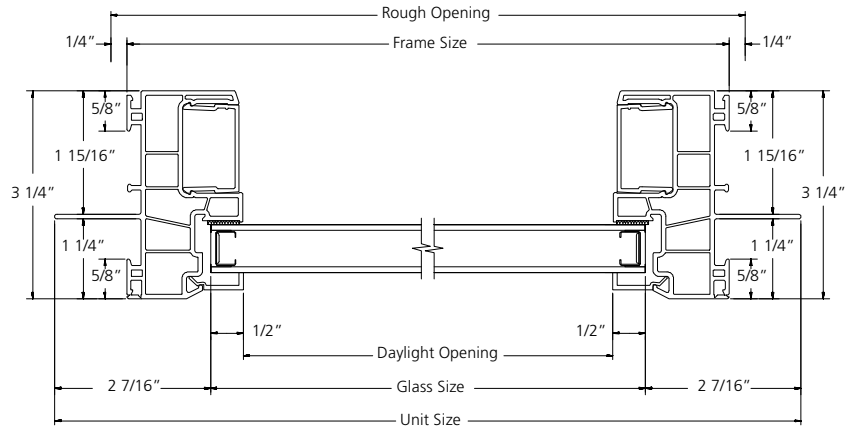

**HORIZONTAL SECTION**

SCALE: 4" = 1'



**PICTURE WINDOWS  
FLUSH FIN**

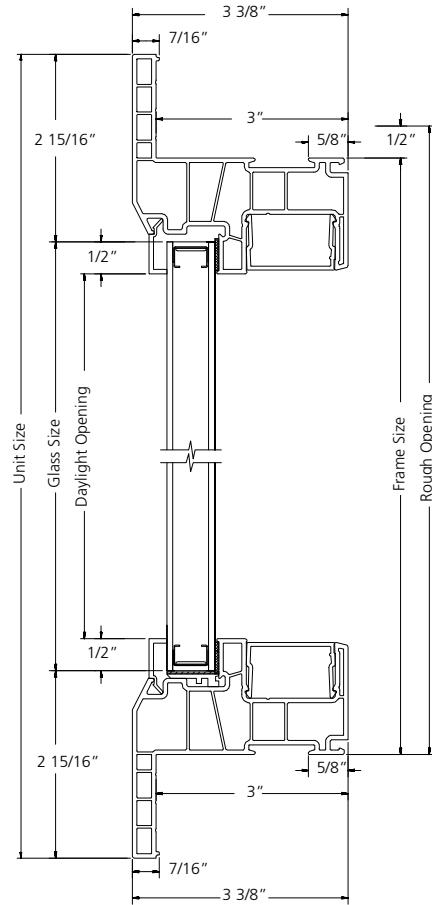

**VERTICAL SECTION**

SCALE: 4" = 1'

**PICTURE WINDOW  
FLUSH FIN**

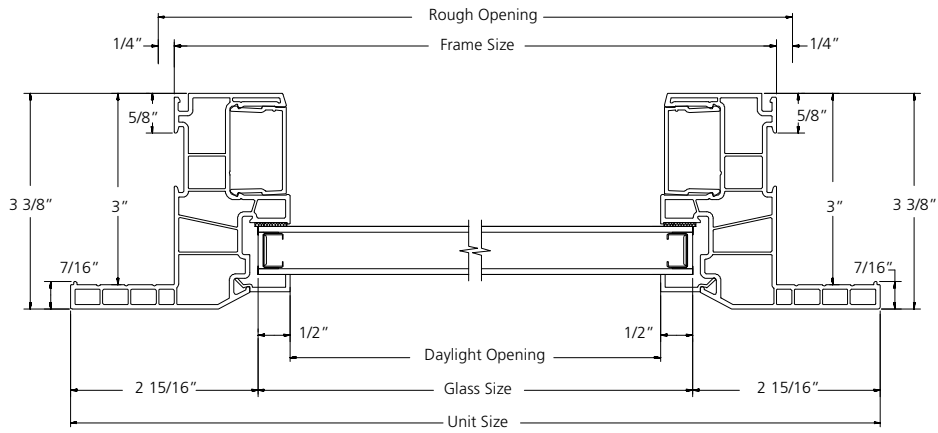

**HORIZONTAL SECTION**

SCALE: 4" = 1'

**PICTURE WINDOWS  
BOX FRAME**

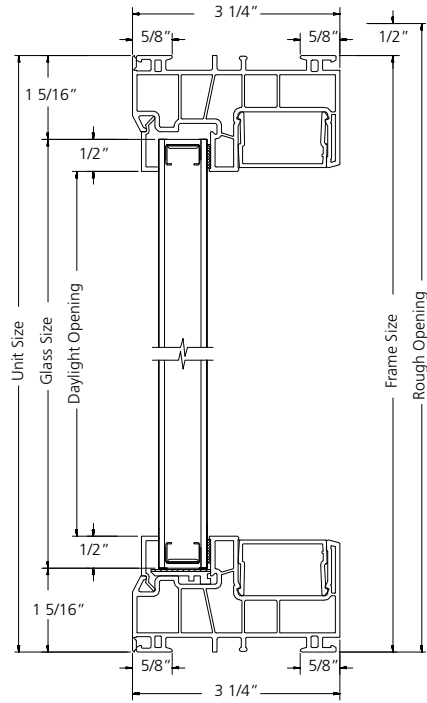

**VERTICAL SECTION**

SCALE: 4" = 1'

**PICTURE WINDOWS  
BOX FRAME**

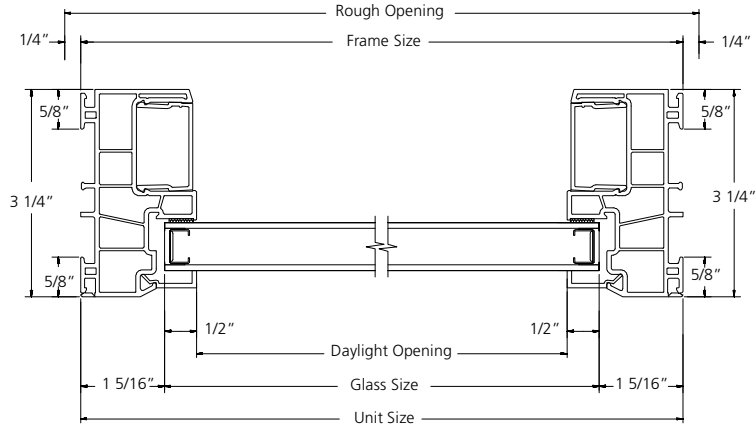

**HORIZONTAL SECTION**

SCALE: 4" = 1'