TABLE OF CONTENTS

Specifications	6-2
Quick Spec Guide	6-3
Elevations/Sizes: 1/4" Scale	
Picture Units	6-4
Quarter Round	6-26
Half Round	6-28
Full Round	6-29
Quarter Circle Segment	6-30
Circle Segment	6-31
Oval	6-32
Extended Quarter Round	6-33
Extended Half Round	6-34
Extended Quarter Segment	6-35
Extended Circle Segment	6-39
Trapezoid	6-43
Clipped Corner	6-47
Pentagon	6-51
Grille Patterns	6-55
Section Details: 6" Scale	6-58

PRODUCT SPECIFICATIONS

MATERIALS

The extruded vinyl profiles comply with the performance requirements of AAMA 303-97. The colors extend through the profile of the extrusion with White, Akmond and Desert Sand colors available. The product is not available in the Western United States markets.

FRAME

All frames and sash are assembled using fusion-welding technology for added strength and durability. The frame jamb width is 3-1/4" (90.49mm), and the nominal extrusion exterior wall thickness is 0.060". The wall depth of the double hung product is 1-13/16". The frame incorporates an integral nailing fin which can be easily removed to allow the unit to be used in a replacement window application. Weep holes are included on the frame to ensure standing water is directed to the exterior plane of the unit. An interior and exterior accessory groove is standard to accommodate various frame accessory and assembly options on the product. Optional brickmould and snap in flat casing profiles are also available.

GLAZING

3/4" (19mm) insulated glass consist of two lites of glass sealed around a spacer. The glass is mounted into the sash using a silicone-glazing compound. The insulating glass units comply with the performance requirements of the IGCC in accordance with either ASTM E774 or E2190. All units are exterior glazed.

GLAZING OPTIONS

3/4" (19mm) insulated glass is available in clear, Low-E or Low-E 366, tinted, obscure or other specialty insulating glass as specified. Many glass options are available in tempered glazings.

GRILLES

GBG (Grilles between the Glass) - 5/8" (16mm) and 7/8" (22.2mm) flat or 1" (26mm) contour grilles mounted between the glass panes suspended within the air cavity and color matched to the extrusion color.

EXTENSION JAMBS

Extension jambs are regionally available for JELD-WEN vinyl products. The 9/16" extension jambs are available in pine clear vinyl wrapped, primed wood, red oak and maple finishes and can be specified on three or four sides of the product.

ADDITIONAL ACCESSORIES

Additional accessories are available for JELD-WEN Vinyl products. Please contact your local building supply retailer for a complete listing of the additional accessories.

INSTALLATION

Installation per JELD-WEN Installation Method for Vinyl Windows JII001, JII010 or JII011. See www.jeld-wen.com/resources for instructions.

PERFORMANCE

NFRC Certified - (rated and labeled in accordance with NFRC)

AAMA/NWDMA I.S.2-97

















































































R20-DP rated

Optional R50 DP ratings are available (East only).

QUICK SPEC GUIDE

SPECIFICATION	STANDARD FEATURES	OPTIONAL FEATURES <i>Some options may require additional lead times. Consult your JELD-WEN Sales Representative.</i>
COLOR	<ul style="list-style-type: none"> White 	<ul style="list-style-type: none"> Almond Desert Sand <p><i>not available in all regions</i></p>
SIZE (Rough Opening)	<ul style="list-style-type: none"> Width: 10" to 96" Height: 10" to 96" 40 sq. foot max in single unit 	<ul style="list-style-type: none"> Radius and Geometrics sizes limited to 40 sq. foot max. and may be further limited due to configuration.
FRAME	<ul style="list-style-type: none"> Integral Nail Fin 	<ul style="list-style-type: none"> Pocket/Block Frame Integral Dual Wall Flush Fin (West)* Integral Stucco Fin w/stucco key (West) <p><i>*Not available on radius units</i></p>
GLAZING	<ul style="list-style-type: none"> Insulating Low-E 	<ul style="list-style-type: none"> Clear Low-E 366 Low-E Keep Clean Obscure Bronze Gray Gluechip Rain Azurlite Laminated All glass available tempered <p><i>regional glass availabilities may differ</i></p>
GRILLES		<ul style="list-style-type: none"> 1" Contour GBG (grilles between the glass) 5/8" Flat GBG (grilles between the glass) 5/8" Contour GBG (grilles between the glass) (East) 7/8" Flat GBG (grilles between the glass) (East)
JAMB DEPTH	<ul style="list-style-type: none"> 2-29/32" 	<ul style="list-style-type: none"> Integral J-channel (East) - 2-29/32" Integral Dual Wall Flush Fin (West) - 2-29/32" Integral Stucco Fin w/stucco key (West) - 2-29/32" 4-9/16" Extension Jamb Applied (East only) 6-9/16" Extension Jamb Applied (East only)
ACCESSORIES		<ul style="list-style-type: none"> Extension Jamb Retainer Drip Cap Drywall Retainer 14 Degree Sloped Sill Adaptor (factory applied available) Head and Sill Expander (East)

PICTURE UNITS

UNIT SIZE ROUGH OPENING FRAME SIZE DAYLIGHT OPENING	13 3/4" 12" 11 1/2" 7 29/32"	19 3/4" 18" 17 1/2" 13 29/32"	21 3/4" 20" 19 1/2" 15 29/32"	23 3/4" 22" 21 1/2" 17 29/32"	25 3/4" 24" 23 1/2" 19 29/32"	27 3/4" 26" 25 1/2" 21 29/32"	29 3/4" 28" 27 1/2" 23 29/32"	31 3/4" 30" 29 1/2" 25 29/32"	33 3/4" 32" 31 1/2" 27 29/32"
13 3/4" 12" 11 1/2" 7 29/32"	 7PC1212	 7PC1812	 7PC2012	 7PC2212	 7PC2412	 7PC2612	 7PC2812	 7PC3012	 7PC3212
19 3/4" 18" 17 1/2" 13 29/32"	 7PC1218	 7PC1818	 7PC2018	 7PC2218	 7PC2418	 7PC2618	 7PC2818	 7PC3018	 7PC3218
25 3/4" 24" 23 1/2" 19 29/32"	 7PC1224	 7PC1824	 7PC2024	 7PC2224	 7PC2424	 7PC2624	 7PC2824	 7PC3024	 7PC3224
31 3/4" 30" 29 1/2" 25 29/32"	 7PC1230	 7PC1830	 7PC2030	 7PC2230	 7PC2430	 7PC2630	 7PC2830	 7PC3030	 7PC3230
37 3/4" 36" 35 1/2" 31 29/32"	 7PC1236	 7PC1836	 7PC2036	 7PC2236	 7PC2436	 7PC2636	 7PC2836	 7PC3036	 7PC3236
38 3/4" 37" 36 1/2" 32 29/32"	 7PC1237	 7PC1837	 7PC2037	 7PC2237	 7PC2437	 7PC2637	 7PC2837	 7PC3037	 7PC3237
39 3/4" 38" 37 1/2" 33 29/32"	 7PC1238	 7PC1838	 7PC2038	 7PC2238	 7PC2438	 7PC2638	 7PC2838	 7PC3038	 7PC3238
42 3/4" 41" 40 1/2" 36 29/32"	 7PC1241	 7PC1841	 7PC2041	 7PC2241	 7PC2441	 7PC2641	 7PC2841	 7PC3041	 7PC3241
43 3/4" 42" 41 1/2" 37 29/32"	 7PC1242	 7PC1842	 7PC2042	 7PC2242	 7PC2442	 7PC2642	 7PC2842	 7PC3042	 7PC3242

ELEVATION SYMBOL LEGEND:
 ### NUMBER INDICATES DESIGN PRESSURE (DP) RATING WITH STANDARD GLAZING.

SCALE: 1/4" = 1'

PICTURE UNITS

UNIT SIZE
ROUGH OPENING
FRAME SIZE
DAYLIGHT OPENING

	13 3/4" 12" 11 1/2" 7 29/32"	19 3/4" 18" 17 1/2" 13 29/32"	21 3/4" 20" 19 1/2" 15 29/32"	23 3/4" 22" 21 1/2" 17 29/32"	25 3/4" 24" 23 1/2" 19 29/32"	27 3/4" 26" 25 1/2" 21 29/32"	29 3/4" 28" 27 1/2" 23 29/32"	31 3/4" 30" 29 1/2" 25 29/32"	33 3/4" 32" 31 1/2" 27 29/32"
49 3/4" 48" 47 1/2" 43 29/32"	20* 7PC1248	20* 7PC1848	20* 7PC2048	20* 7PC2248	20* 7PC2448	20* 7PC2648	20* 7PC2848	20* 7PC3048	20* 7PC3248
50 3/4" 49" 48 1/2" 44 29/32"	20* 7PC1249	20* 7PC1849	20* 7PC2049	20* 7PC2249	20* 7PC2449	20* 7PC2649	20* 7PC2849	20* 7PC3049	20* 7PC3249
54 3/4" 53" 52 1/2" 48 29/32"	20* 7PC1253	20* 7PC1853	20* 7PC2053	20* 7PC2253	20* 7PC2453	20* 7PC2653	20* 7PC2853	20* 7PC3053	20* 7PC3253
55 3/4" 54" 53 1/2" 49 29/32"	20* 7PC1254	20* 7PC1854	20* 7PC2054	20* 7PC2254	20* 7PC2454	20* 7PC2654	20* 7PC2854	20* 7PC3054	20* 7PC3254
58 3/4" 57" 56 1/2" 52 29/32"	20* 7PC1257	20* 7PC1857	20* 7PC2057	20* 7PC2257	20* 7PC2457	20* 7PC2657	20* 7PC2857	20* 7PC3057	20* 7PC3257
61 3/4" 60" 59 1/2" 55 29/32"	20* 7PC1260	20* 7PC1860	20* 7PC2060	20* 7PC2260	20* 7PC2460	20* 7PC2660	20* 7PC2860	20* 7PC3060	20* 7PC3260

ELEVATION SYMBOL LEGEND:
##* NUMBER INDICATES DESIGN PRESSURE (DP) RATING WITH STANDARD GLAZING.

SCALE: 1/4" = 1'

PICTURE UNITS

UNIT SIZE	13 3/4"	19 3/4"	21 3/4"	23 3/4"	25 3/4"	27 3/4"	29 3/4"	31 3/4"	33 3/4"
ROUGH OPENING	12"	18"	20"	22"	24"	26"	28"	30"	32"
FRAME SIZE	11 1/2"	17 1/2"	19 1/2"	21 1/2"	23 1/2"	25 1/2"	27 1/2"	29 1/2"	31 1/2"
DAYLIGHT OPENING	7 29/32"	13 29/32"	15 29/32"	17 29/32"	19 29/32"	21 29/32"	23 29/32"	25 29/32"	27 29/32"
63 3/4" 62" 61 1/2" 59 29/32"	20* 7PC1262	20* 7PC1862	20* 7PC2062	20* 7PC2262	20* 7PC2462	20* 7PC2662	20* 7PC2862	20* 7PC3062	20* 7PC3262
66 3/4" 65" 64 1/2" 60 29/32"	20* 7PC1265	20* 7PC1865	20* 7PC2065	20* 7PC2265	20* 7PC2465	20* 7PC2665	20* 7PC2865	20* 7PC3065	20* 7PC3265
67 3/4" 66" 65 1/2" 61 29/32"	20* 7PC1266	20* 7PC1866	20* 7PC2066	20* 7PC2266	20* 7PC2466	20* 7PC2666	20* 7PC2866	20* 7PC3066	20* 7PC3266
70 3/4" 69" 68 1/2" 64 29/32"	20* 7PC1269	20* 7PC1869	20* 7PC2069	20* 7PC2269	20* 7PC2469	20* 7PC2669	20* 7PC2869	20* 7PC3069	20* 7PC3269
73 3/4" 72" 71 1/2" 67 29/32"	20* 7PC1272	20* 7PC1872	20* 7PC2072	20* 7PC2272	20* 7PC2472	20* 7PC2672	20* 7PC2872	20* 7PC3072	20* 7PC3272

ELEVATION SYMBOL LEGEND:
 ###* NUMBER INDICATES DESIGN PRESSURE (DP) RATING WITH STANDARD GLAZING.

SCALE: 1/4" = 1'

PICTURE UNITS

	UNIT SIZE 13 3/4"	19 3/4"	21 3/4"	23 3/4"	25 3/4"	27 3/4"	29 3/4"	31 3/4"	33 3/4"
ROUGH OPENING	12"	18"	20"	22"	24"	26"	28"	30"	32"
FRAME SIZE	11 1/2"	17 1/2"	19 1/2"	21 1/2"	23 1/2"	25 1/2"	27 1/2"	29 1/2"	31 1/2"
DAYLIGHT OPENING	7 29/32"	13 29/32"	15 29/32"	17 29/32"	19 29/32"	21 29/32"	23 29/32"	25 29/32"	27 29/32"
75 3/4" 74" 73 1/2" 69 29/32"									
	7PC1274	7PC1874	7PC2074	7PC2274	7PC2474	7PC2674	7PC2874	7PC3074	7PC3274
78 3/4" 77" 76 1/2" 72 29/32"									
	7PC1277	7PC1877	7PC2077	7PC2277	7PC2477	7PC2677	7PC2877	7PC3077	7PC3277
79 3/4" 78" 77 1/2" 73 29/32"									
	7PC1278	7PC1878	7PC2078	7PC2278	7PC2478	7PC2678	7PC2878	7PC3078	7PC3278
85 3/4" 84" 83 1/2" 79 29/32"									
	7PC1284	7PC1884	7PC2084	7PC2284	7PC2484	7PC2684	7PC2884	7PC3084	7PC3284

ELEVATION SYMBOL LEGEND:
 ##* NUMBER INDICATES DESIGN PRESSURE (DP) RATING WITH STANDARD GLAZING.

SCALE: 1/4" = 1'















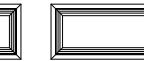
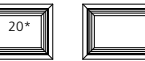





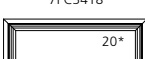
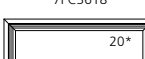
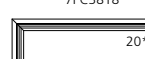
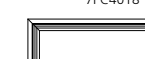

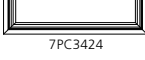
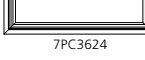
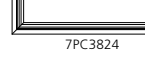
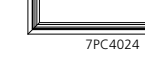







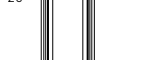
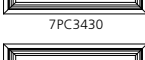
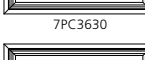
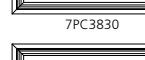
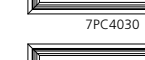



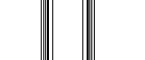
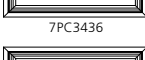
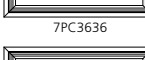
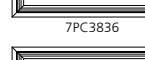
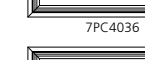

PICTURE UNITS

	13 3/4"	19 3/4"	21 3/4"	23 3/4"	25 3/4"	27 3/4"	29 3/4"	31 3/4"	33 3/4"
UNIT SIZE	12"	18"	20"	22"	24"	26"	28"	30"	32"
ROUGH OPENING	11 1/2"	17 1/2"	19 1/2"	21 1/2"	23 1/2"	25 1/2"	27 1/2"	29 1/2"	31 1/2"
FRAME SIZE	7 29/32"	13 29/32"	15 29/32"	17 29/32"	19 29/32"	21 29/32"	23 29/32"	25 29/32"	27 29/32"
DAYLIGHT OPENING	20*	20*	20*	20*	20*	20*	20*	20*	20*
	91 3/4"	90"	89 1/2"	85 29/32"					
	7PC1290	7PC1890	7PC2090	7PC2290	7PC2490	7PC2690	7PC2890	7PC3090	7PC3290
	20*	20*	20*	20*	20*	20*	20*	20*	20*
	97 3/4"	96"	95 1/2"	91 29/32"					
	7PC1296	7PC1896	7PC2096	7PC2296	7PC2496	7PC2696	7PC2896	7PC3096	7PC3296

ELEVATION SYMBOL LEGEND:
 ### NUMBER INDICATES DESIGN PRESSURE (DP) RATING WITH STANDARD GLAZING.

SCALE: 1/4" = 1'

PICTURE UNITS

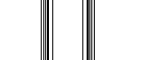
UNIT SIZE	35 3/4"	37 3/4"	39 3/4"	41 3/4"	43 3/4"	47 3/4"
ROUGH OPENING	34"	36"	38"	40"	42"	46"
FRAME SIZE	33 1/2"	35 1/2"	37 1/2"	39 1/2"	41 1/2"	45 1/2"
DAYLIGHT OPENING	29 29/32"	31 29/32"	33 29/32"	35 29/32"	37 29/32"	41 29/32"
13 3/4" 17" 11 1/2" 7 29/32"	 7PC3412	 7PC3612	 7PC3812	 7PC4012	 7PC4212	 7PC4612
19 3/4" 18" 17 1/2" 13 29/32"	 7PC3418	 7PC3618	 7PC3818	 7PC4018	 7PC4218	 7PC4618
25 3/4" 24" 23 1/2" 19 29/32"	 7PC3424	 7PC3624	 7PC3824	 7PC4024	 7PC4224	 7PC4624
31 3/4" 30" 29 1/2" 25 29/32"	 7PC3430	 7PC3630	 7PC3830	 7PC4030	 7PC4230	 7PC4630
37 3/4" 36" 35 1/2" 31 29/32"	 7PC3436	 7PC3636	 7PC3836	 7PC4036	 7PC4236	 7PC4636
38 3/4" 37" 36 1/2" 32 29/32"	 7PC3437	 7PC3637	 7PC3837	 7PC4037	 7PC4237	 7PC4637
39 3/4" 38" 37 1/2" 33 29/32"	 7PC3438	 7PC3638	 7PC3838	 7PC4038	 7PC4238	 7PC4638
42 3/4" 41" 40 1/2" 36 29/32"	 7PC3441	 7PC3641	 7PC3841	 7PC4041	 7PC4241	 7PC4641
43 3/4" 42" 41 1/2" 37 29/32"	 7PC3442	 7PC3642	 7PC3842	 7PC4042	 7PC4242	 7PC4642

ELEVATION SYMBOL LEGEND:
 ### NUMBER INDICATES DESIGN PRESSURE (DP) RATING WITH STANDARD GLAZING.

SCALE: 1/4" = 1'

PICTURE UNITS

UNIT SIZE
ROUGH OPENING
FRAME SIZE
DAYLIGHT OPENING

	35 3/4" 34" 33 1/2" 29 29/32"	37 3/4" 36" 35 1/2" 31 29/32"	39 3/4" 38" 37 1/2" 33 29/32"	41 3/4" 40" 39 1/2" 35 29/32"	43 3/4" 42" 41 1/2" 37 29/32"	47 3/4" 46" 45 1/2" 41 29/32"
49 3/4" 48" 47 1/2" 43 29/32"	20* 7PC3448	20* 7PC3648	20* 7PC3848	20* 7PC4048	20* 7PC4248	20* 7PC4648
50 3/4" 49" 48 1/2" 44 29/32"	20* 7PC3449	20* 7PC3649	20* 7PC3849	20* 7PC4049	20* 7PC4249	20* 7PC4649
54 3/4" 53" 52 1/2" 48 29/32"	20* 7PC3453	20* 7PC3653	20* 7PC3853	20* 7PC4053	20* 7PC4253	20* 7PC4653
55 3/4" 54" 53 1/2" 49 29/32"	20* 7PC3454	20* 7PC3654	20* 7PC3854	20* 7PC4054	20* 7PC4254	20* 7PC4654
58 3/4" 57" 56 1/2" 52 29/32"	20* 7PC3457	20* 7PC3657	20* 7PC3857	20* 7PC4057	20* 7PC4257	20* 7PC4657
61 3/4" 60" 59 1/2" 55 29/32"	20* 7PC3460	20* 7PC3660	20* 7PC3860	20* 7PC4060	20* 7PC4260	20* 7PC4660

ELEVATION SYMBOL LEGEND:
NUMBER INDICATES DESIGN PRESSURE (DP) RATING WITH STANDARD GLAZING.

SCALE: 1/4" = 1'

PICTURE UNITS

UNIT SIZE
ROUGH OPENING
FRAME SIZE
DAYLIGHT OPENING

	35 3/4" 34" 33 1/2" 29 29/32"	37 3/4" 36" 35 1/2" 31 29/32"	39 3/4" 38" 37 1/2" 33 29/32"	41 3/4" 40" 39 1/2" 35 29/32"	43 3/4" 42" 41 1/2" 37 29/32"	47 3/4" 46" 45 1/2" 41 29/32"
63 3/4" 62" 61 1/2" 59 29/32"	20* 7PC3462	20* 7PC3662	20* 7PC3862	20* 7PC4062	20* 7PC4262	20* 7PC4662
66 3/4" 65" 64 1/2" 60 29/32"	20* 7PC3465	20* 7PC3665	20* 7PC3865	20* 7PC4065	20* 7PC4265	20* 7PC4665
67 3/4" 66" 65 1/2" 61 29/32"	20* 7PC3466	20* 7PC3666	20* 7PC3866	20* 7PC4066	20* 7PC4266	20* 7PC4666
70 3/4" 69" 68 1/2" 64 29/32"	20* 7PC3469	20* 7PC3669	20* 7PC3869	20* 7PC4069	20* 7PC4269	20* 7PC4669
73 3/4" 72" 71 1/2" 67 29/32"	20* 7PC3472	20* 7PC3672	20* 7PC3872	20* 7PC4072	20* 7PC4272	20* 7PC4672

ELEVATION SYMBOL LEGEND:
NUMBER INDICATES DESIGN PRESSURE (DP) RATING WITH STANDARD GLAZING.

SCALE: 1/4" = 1'

PICTURE UNITS

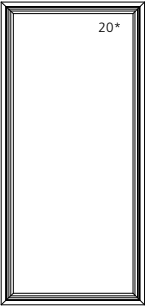
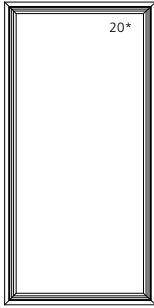
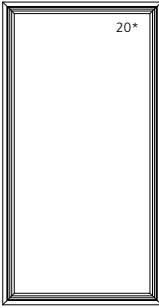
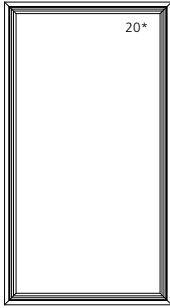
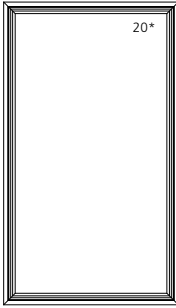
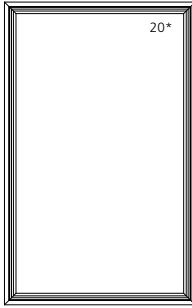
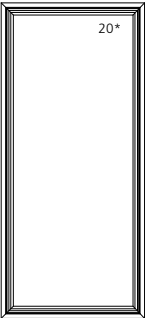
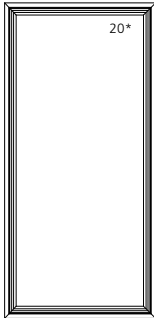
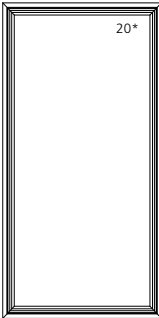
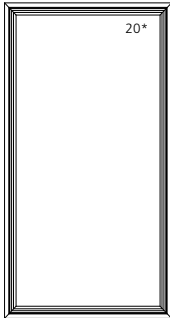
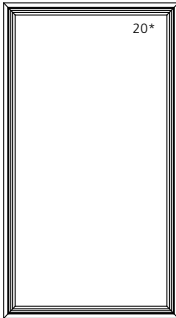
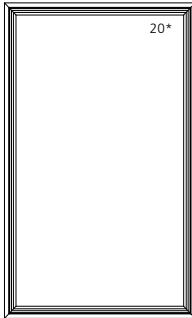
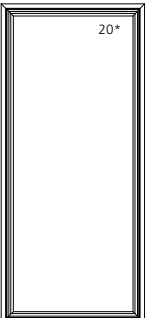
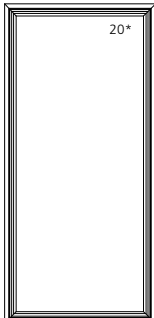
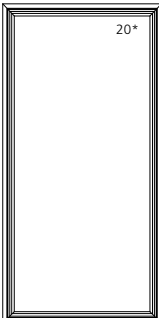
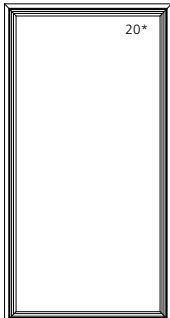
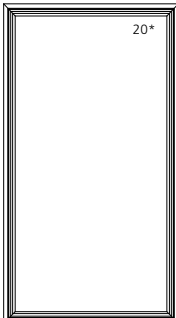
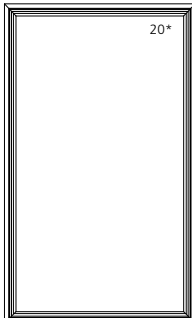
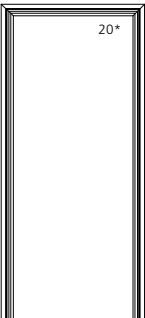
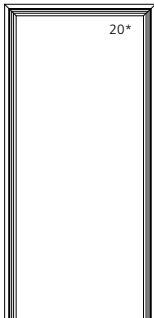
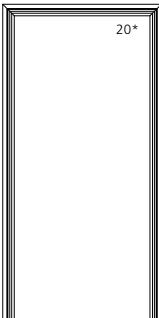
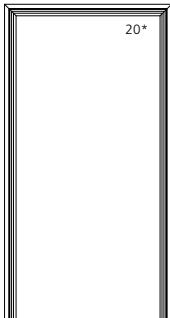
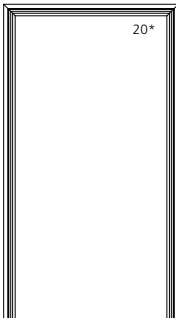
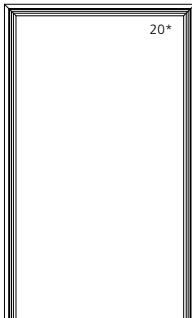
UNIT SIZE	35 3/4"	37 3/4"	39 3/4"	41 3/4"	43 3/4"	47 3/4"
ROUGH OPENING	34"	36"	38"	40"	42"	46"
FRAME SIZE	33 1/2"	35 1/2"	37 1/2"	39 1/2"	41 1/2"	45 1/2"
DAYLIGHT OPENING	29 29/32"	31 29/32"	33 29/32"	35 29/32"	37 29/32"	41 29/32"
75 3/4" 74" 73 1/2" 69 29/32"	 20*	 20*	 20*	 20*	 20*	 20*
73 3/4" 72" 71 1/2" 67 29/32"	 20*	 20*	 20*	 20*	 20*	 20*
79 3/4" 78" 77 1/2" 73 29/32"	 20*	 20*	 20*	 20*	 20*	 20*
85 3/4" 84" 83 1/2" 79 29/32"	 20*	 20*	 20*	 20*	 20*	 20*

ELEVATION SYMBOL LEGEND:
 ### NUMBER INDICATES DESIGN PRESSURE (DP) RATING WITH STANDARD GLAZING.

SCALE: 1/4" = 1'



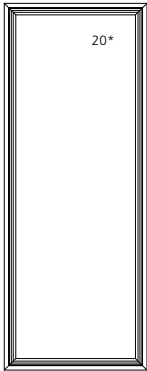
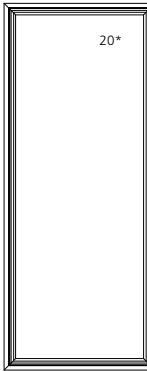
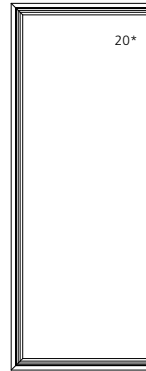
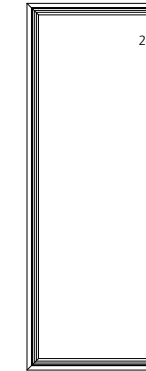
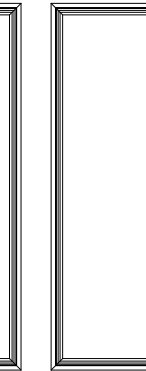
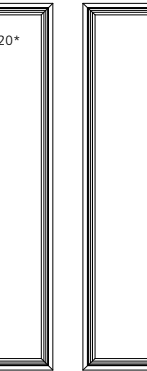
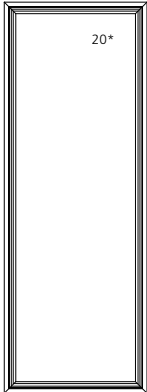
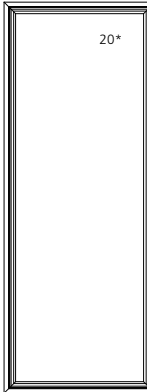
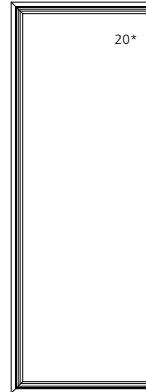
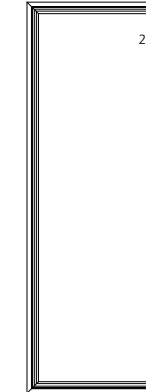
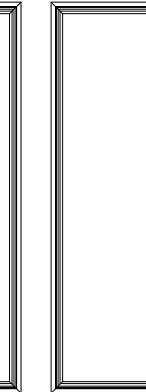
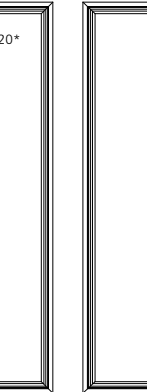









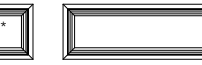



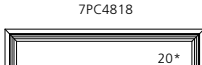

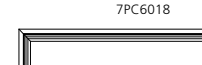









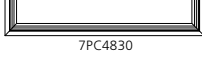
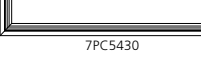
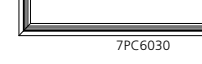

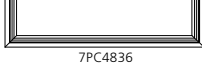

PICTURE UNITS

	35 3/4"	37 3/4"	39 3/4"	41 3/4"	43 3/4"	47 3/4"
UNIT SIZE	34"	36"	38"	40"	42"	46"
ROUGH OPENING	33 1/2"	35 1/2"	37 1/2"	39 1/2"	41 1/2"	45 1/2"
FRAME SIZE	29 29/32"	31 29/32"	33 29/32"	35 29/32"	37 29/32"	41 29/32"
DAYLIGHT OPENING						
						
	7PC3490	7PC3690	7PC3890	7PC4090	7PC4290	7PC4690
						
	7PC3496	7PC3696	7PC3896	7PC4096	7PC4296	7PC4696

ELEVATION SYMBOL LEGEND:
NUMBER INDICATES DESIGN PRESSURE (DP) RATING WITH STANDARD GLAZING.

SCALE: 1/4" = 1'

PICTURE UNITS

UNIT SIZE ROUGH OPENING FRAME SIZE DAYLIGHT OPENING	49 3/4" 48" 47 1/2" 43 29/32"	55 3/4" 54" 53 1/2" 49 29/32"	61 3/4" 60" 59 1/2" 55 29/32"	63 3/4" 62" 61 1/2" 57 29/32"
13 3/4" 12" 11 1/2" 7 29/32"	 20*	 20*	 20*	 20*
	7PC4812	7PC5412	7PC6012	7PC6212
19 3/4" 18" 17 1/2" 13 29/32"	 20*	 20*	 20*	 20*
	7PC4818	7PC5418	7PC6018	7PC6218
25 3/4" 24" 23 1/2" 19 29/32"	 20*	 20*	 20*	 20*
	7PC4824	7PC5424	7PC6024	7PC6224
31 3/4" 30" 29 1/2" 25 29/32"	 20*	 20*	 20*	 20*
	7PC4830	7PC5430	7PC6030	7PC6230
37 3/4" 36" 35 1/2" 31 29/32"	 20*	 20*	 20*	 20*
	7PC4836	7PC5436	7PC6036	7PC6236
38 3/4" 37" 36 1/2" 32 29/32"	 20*	 20*	 20*	 20*
	7PC4837	7PC5437	7PC6037	7PC6237
39 3/4" 38" 37 1/2" 33 29/32"	 20*	 20*	 20*	 20*
	7PC4838	7PC5438	7PC6038	7PC6238
42 3/4" 41" 40 1/2" 36 29/32"	 20*	 20*	 20*	 20*
	7PC4841	7PC5441	7PC6041	7PC6241
43 3/4" 42" 41 1/2" 37 29/32"	 20*	 20*	 20*	 20*
	7PC4842	7PC5442	7PC6042	7PC6242

ELEVATION SYMBOL LEGEND:
##* NUMBER INDICATES DESIGN PRESSURE (DP) RATING WITH STANDARD GLAZING.

SCALE: 1/4" = 1'

PICTURE UNITS

UNIT SIZE
ROUGH OPENING
FRAME SIZE
DAYLIGHT OPENING

49 3/4"
48"
47 1/2"
43 29/32"

55 3/4"
54"
53 1/2"
49 29/32"

61 3/4"
60"
59 1/2"
55 29/32"

63 3/4"
62"
61 1/2"
57 29/32"

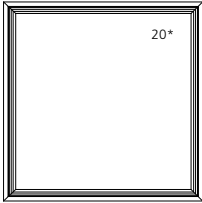
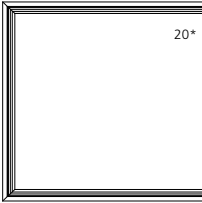
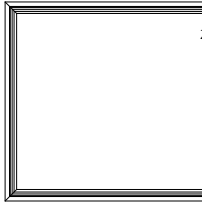
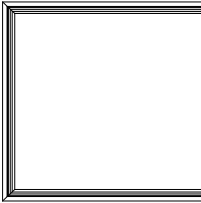
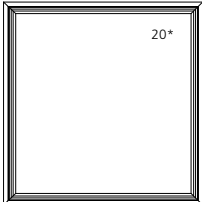
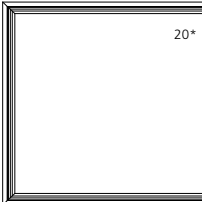
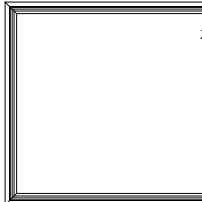
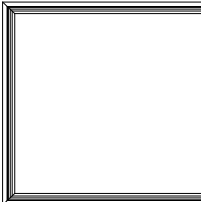
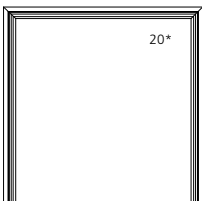
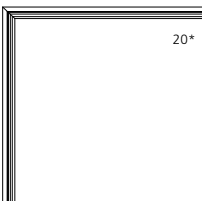
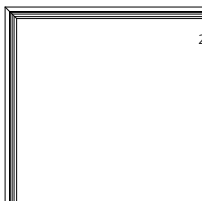
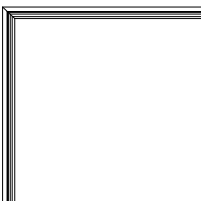
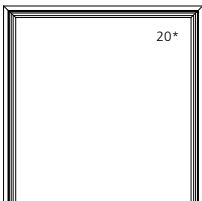
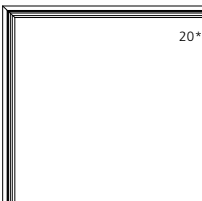
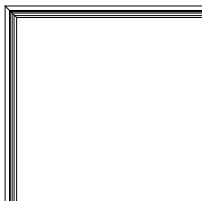
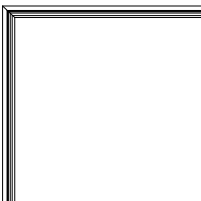
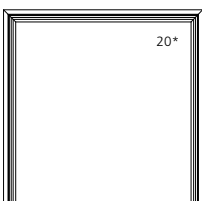
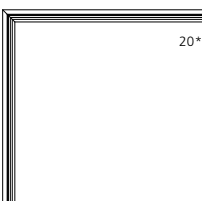
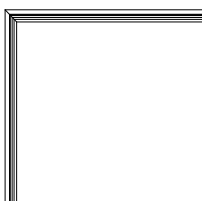
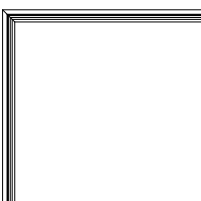
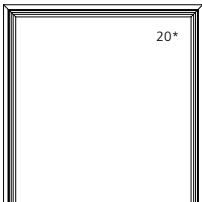
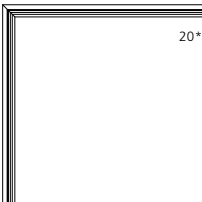
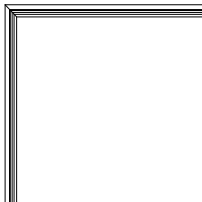
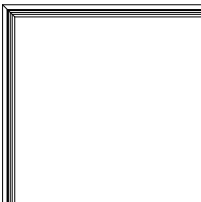
49 3/4" 48" 47 1/2" 43 29/32"	 20* 7PC4848	 20* 7PC5448	 20* 7PC6048	 20* 7PC6248
50 3/4" 49" 48 1/2" 44 29/32"	 20* 7PC4849	 20* 7PC5449	 20* 7PC6049	 20* 7PC6249
54 3/4" 53" 52 1/2" 48 29/32"	 20* 7PC4853	 20* 7PC5453	 20* 7PC6053	 20* 7PC6253
55 3/4" 54" 53 1/2" 49 29/32"	 20* 7PC4854	 20* 7PC5454	 20* 7PC6054	 20* 7PC6254
58 3/4" 57" 56 1/2" 52 29/32"	 20* 7PC4857	 20* 7PC5457	 20* 7PC6057	 20* 7PC6257
61 3/4" 60" 59 1/2" 55 29/32"	 20* 7PC4860	 20* 7PC5460	 20* 7PC6060	 20* 7PC6260

ELEVATION SYMBOL LEGEND:
##* NUMBER INDICATES DESIGN PRESSURE (DP) RATING WITH STANDARD GLAZING.

SCALE: 1/4" = 1'

PICTURE UNITS

UNIT SIZE
ROUGH OPENING
FRAME SIZE
DAYLIGHT OPENING

49 3/4"
48"
47 1/2"
43 29/32"

55 3/4"
54"
53 1/2"
49 29/32"

61 3/4"
60"
59 1/2"
55 29/32"

63 3/4"
62"
61 1/2"
57 29/32"

63 3/4"
62"
61 1/2"
59 29/32"



7PC4862

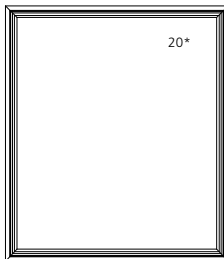

7PC5462

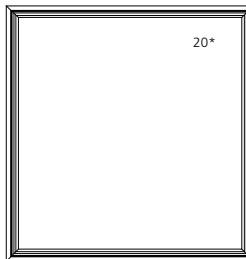

7PC6062

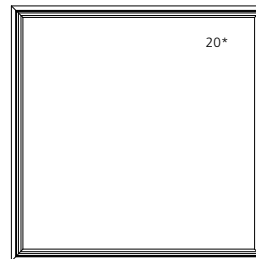

7PC6262

66 3/4"
65"
64 1/2"
60 29/32"



7PC4865

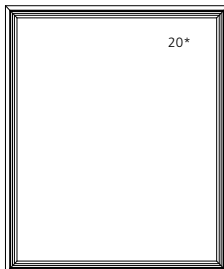

7PC5465

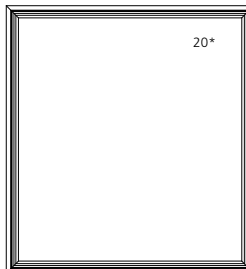

7PC6065

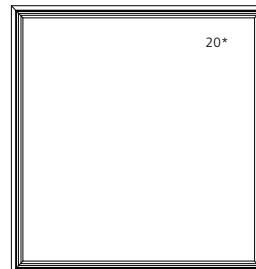

7PC6265

67 3/4"
66"
65 1/2"
61 29/32"

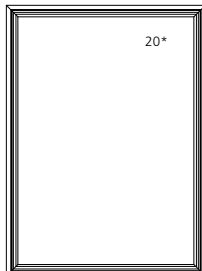

7PC4866

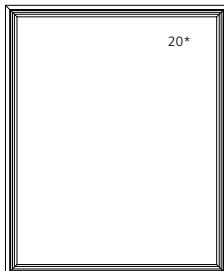

7PC5466

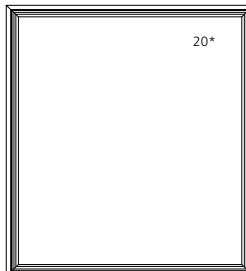

7PC6066

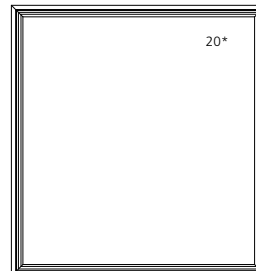

7PC6266

70 3/4"
69"
68 1/2"
64 29/32"



7PC4869

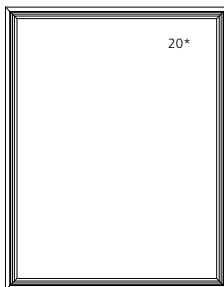

7PC5469

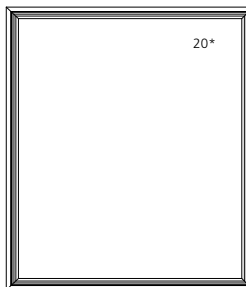

7PC6069

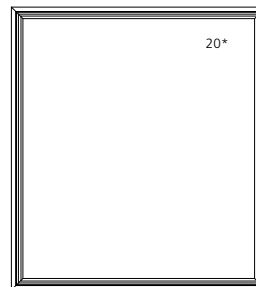

7PC6269

73 3/4"
72"
71 1/2"
67 29/32"



7PC4872

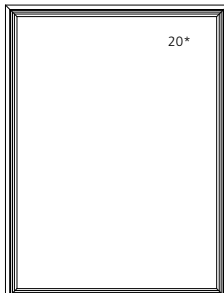

7PC5472

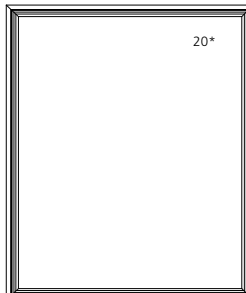

7PC6072

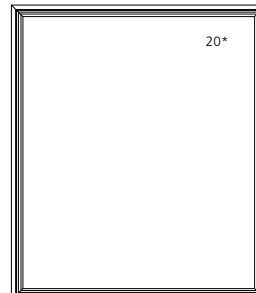





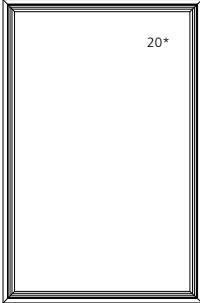
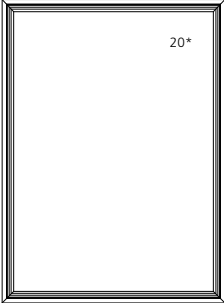

7PC6272

ELEVATION SYMBOL LEGEND:
NUMBER INDICATES DESIGN PRESSURE (DP) RATING WITH STANDARD GLAZING.

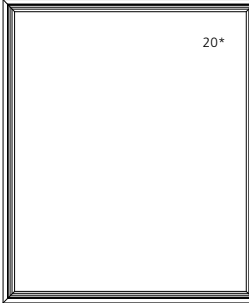
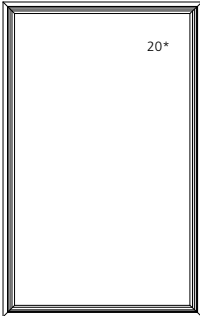
SCALE: 1/4" = 1'

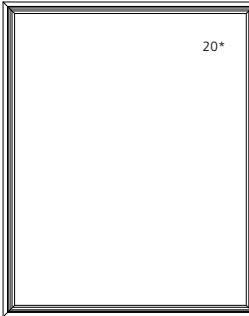
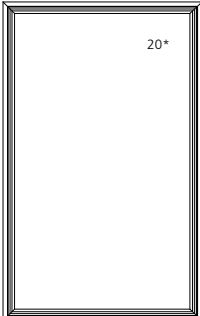
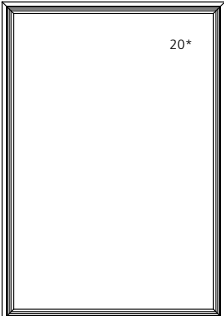
PICTURE UNITS

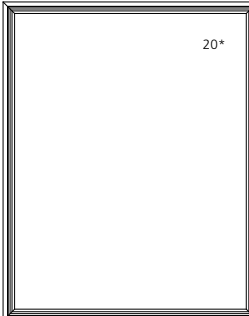
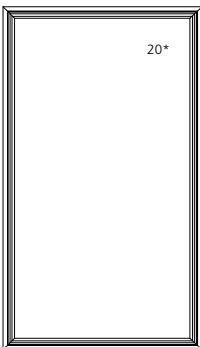
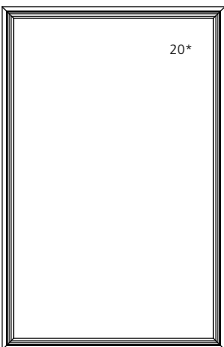
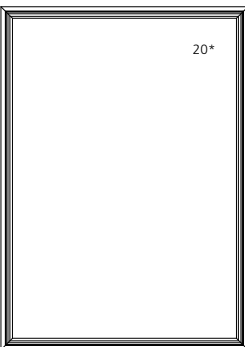
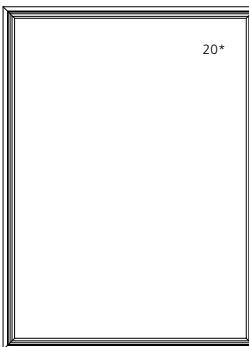
	UNIT SIZE ROUGH OPENING FRAME SIZE DAYLIGHT OPENING	49 3/4" 48" 47 1/2" 43 29/32"	55 3/4" 54" 53 1/2" 49 29/32"	61 3/4" 60" 59 1/2" 55 29/32"	63 3/4" 62" 61 1/2" 57 29/32"
75 3/4" 74" 73 1/2" 69 29/32"					
	7PC4874	7PC5474	7PC6074	7PC6274	
78 3/4" 77" 76 1/2" 72 29/32"					
	7PC4877	7PC5477	7PC6077	7PC6277	
79 3/4" 78" 77 1/2" 73 29/32"					
	7PC4878	7PC5478	7PC6078	7PC6278	
85 3/4" 84" 83 1/2" 79 29/32"					
	7PC4884	7PC5484	7PC6084	7PC6284	

ELEVATION SYMBOL LEGEND:
##* NUMBER INDICATES DESIGN PRESSURE (DP) RATING WITH STANDARD GLAZING.

SCALE: 1/4" = 1'



























PICTURE UNITS

	UNIT SIZE ROUGH OPENING FRAME SIZE DAYLIGHT OPENING	49 3/4" 48" 47 1/2" 43 29/32"	55 3/4" 54" 53 1/2" 49 29/32"	61 3/4" 60" 59 1/2" 55 29/32"
91 3/4" 90" 89 1/2" 85 29/32"		20*	20*	20*
		7PC4890	7PC5490	7PC6090
97 3/4" 96" 95 1/2" 91 29/32"		20*	20*	20*
		7PC4896	7PC5496	7PC6096

ELEVATION SYMBOL LEGEND:
##* NUMBER INDICATES DESIGN PRESSURE (DP) RATING WITH STANDARD GLAZING.

SCALE: 1/4" = 1'

PICTURE UNITS

UNIT SIZE ROUGH OPENING FRAME SIZE DAYLIGHT OPENING	67 3/4" 66" 65 1/2" 61 29/32"	73 3/4" 72" 71 1/2" 67 29/32"	79 3/4" 78" 77 1/2" 73 29/32"
13 3/4" 12" 11 1/2" 7 29/32"	 20*	 20*	 20*
	7PC6612	7PC7212	7PC7812
19 3/4" 18" 17 1/2" 13 29/32"	 20*	 20*	 20*
	7PC6618	7PC7218	7PC7818
25 3/4" 24" 23 1/2" 19 29/32"	 20*	 20*	 20*
	7PC6624	7PC7224	7PC7824
31 3/4" 30" 29 1/2" 25 29/32"	 20*	 20*	 20*
	7PC6630	7PC7230	7PC7830
37 3/4" 36" 35 1/2" 31 29/32"	 20*	 20*	 20*
	7PC6636	7PC7236	7PC7836
38 3/4" 37" 36 1/2" 32 29/32"	 20*	 20*	 20*
	7PC6637	7PC7237	7PC7837
39 3/4" 38" 37 1/2" 33 29/32"	 20*	 20*	 20*
	7PC6638	7PC7238	7PC7838
42 3/4" 41" 40 1/2" 36 29/32"	 20*	 20*	 20*
	7PC6641	7PC7241	7PC7841
43 3/4" 42" 41 1/2" 37 29/32"	 20*	 20*	 20*
	7PC6642	7PC7242	7PC7842

ELEVATION SYMBOL LEGEND:
##* NUMBER INDICATES DESIGN PRESSURE (DP) RATING WITH STANDARD GLAZING.

SCALE: 1/4" = 1'



PICTURE UNITS

UNIT SIZE
ROUGH OPENING
FRAME SIZE
DAYLIGHT OPENING

67 3/4"
66"
65 1/2"
61 29/32"

73 3/4"
72"
71 1/2"
67 29/32"

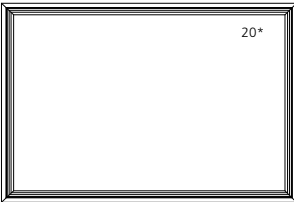
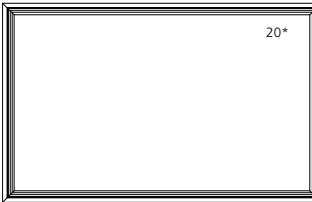
79 3/4"
78"
77 1/2"
73 29/32"

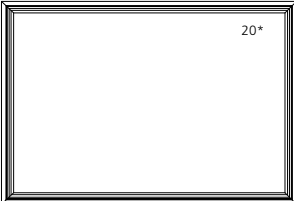
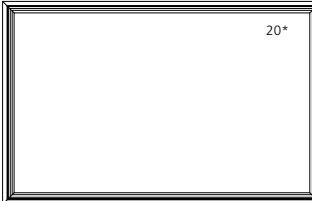
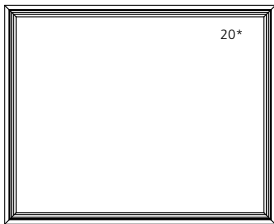
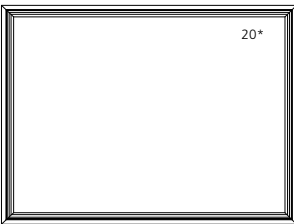
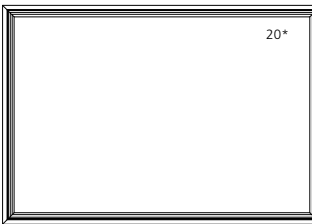
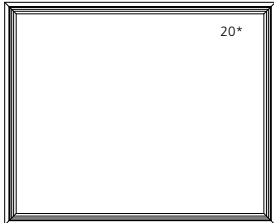
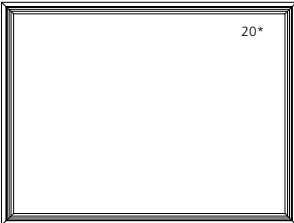
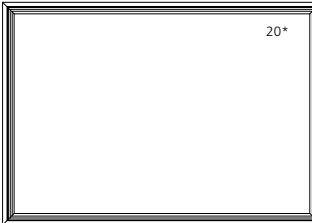
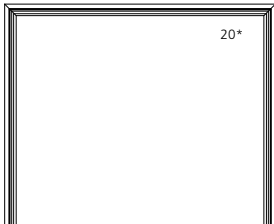
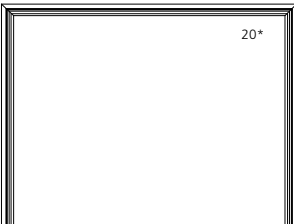
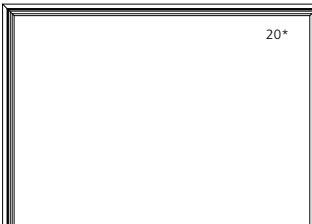
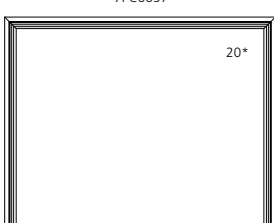
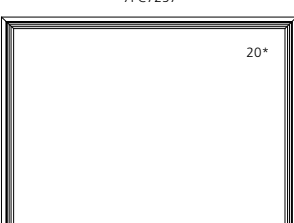
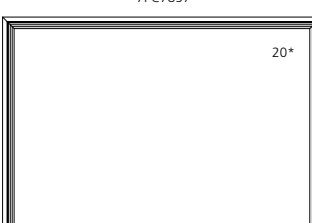
49 3/4" 48" 47 1/2" 43 29/32"	 20*	 20*	 20*
50 3/4" 49" 48 1/2" 44 29/32"	 20*	 20*	 20*
54 3/4" 53" 52 1/2" 48 29/32"	 20*	 20*	 20*
55 3/4" 54" 53 1/2" 49 29/32"	 20*	 20*	 20*
58 3/4" 57" 56 1/2" 52 29/32"	 20*	 20*	 20*
61 3/4" 60" 59 1/2" 55 29/32"	 20*	 20*	 20*

ELEVATION SYMBOL LEGEND:
NUMBER INDICATES DESIGN PRESSURE (DP) RATING WITH STANDARD GLAZING.

SCALE: 1/4" = 1'

PICTURE UNITS

UNIT SIZE
ROUGH OPENING
FRAME SIZE
DAYLIGHT OPENING

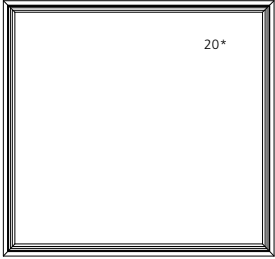
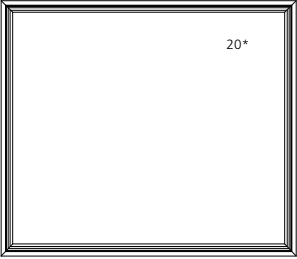
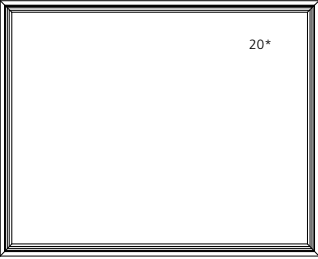
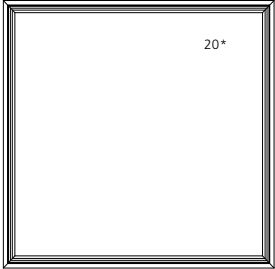
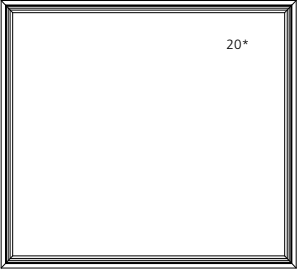
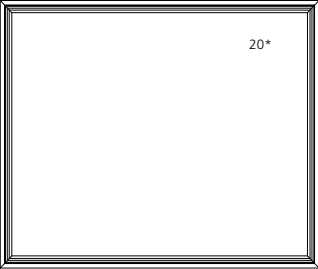
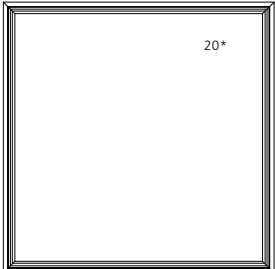
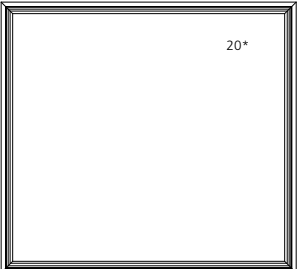
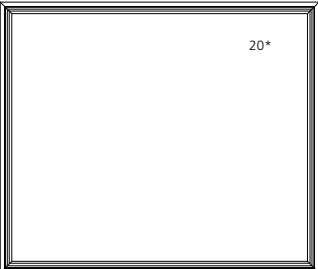
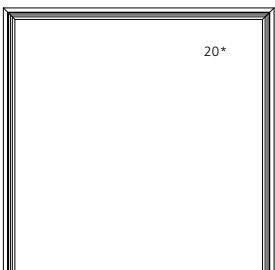
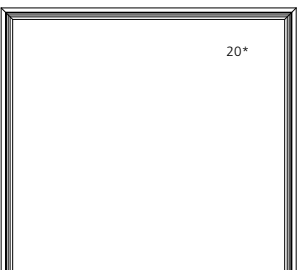
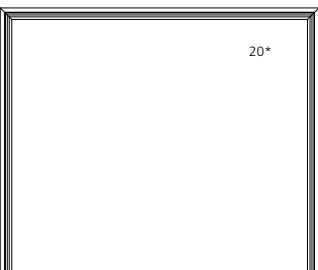
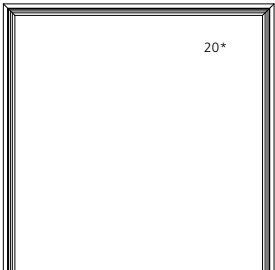
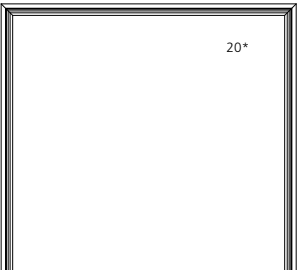
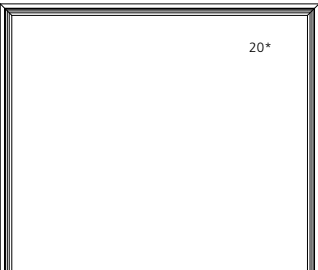
	67 3/4" 66" 65 1/2" 61 29/32"	73 3/4" 72" 71 1/2" 67 29/32"	79 3/4" 78" 77 1/2" 73 29/32"
63 3/4" 62" 61 1/2" 59 29/32"	 20* 7PC6662	 20* 7PC7262	 20* 7PC7862
66 3/4" 65" 64 1/2" 60 29/32"	 20* 7PC6665	 20* 7PC7265	 20* 7PC7865
67 3/4" 66" 65 1/2" 61 29/32"	 20* 7PC6666	 20* 7PC7266	 20* 7PC7866
70 3/4" 69" 68 1/2" 64 29/32"	 20* 7PC6669	 20* 7PC7269	 20* 7PC7869
73 3/4" 72" 71 1/2" 67 29/32"	 20* 7PC6672	 20* 7PC7272	 20* 7PC7872

ELEVATION SYMBOL LEGEND:
NUMBER INDICATES DESIGN PRESSURE (DP) RATING WITH STANDARD GLAZING.

SCALE: 1/4" = 1'

PICTURE UNITS

UNIT SIZE
ROUGH OPENING
FRAME SIZE
DAYLIGHT OPENING

67 3/4"
66"
65 1/2"
61 29/32"

73 3/4"
72"
71 1/2"
67 29/32"

79 3/4"
78"
77 1/2"
73 29/32"

75 3/4"
74"
71 1/2"
69 29/32"

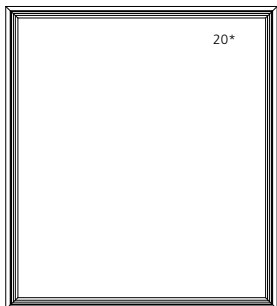

7PC6674

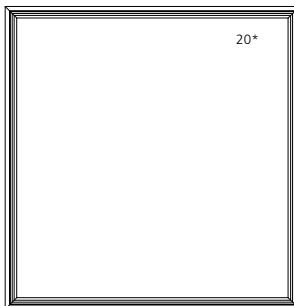

7PC7274

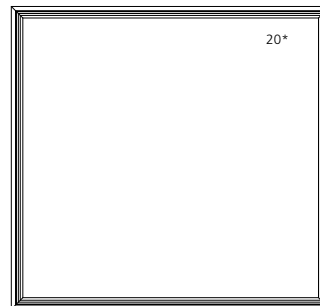

7PC7874

78 3/4"
77"
76 1/2"
72 29/32"

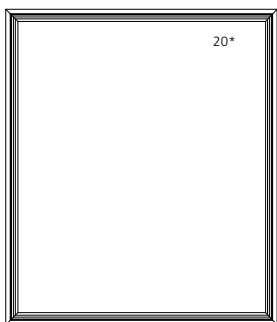

7PC6677

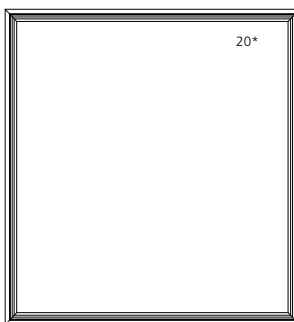

7PC7277

79 3/4"
78"
77 1/2"
73 29/32"

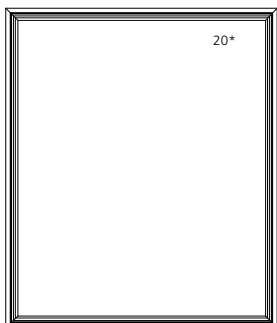

7PC6678

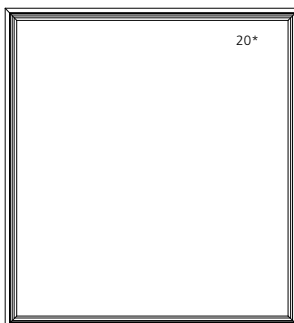

7PC7278

85 3/4"
84"
83 1/2"
79 29/32"

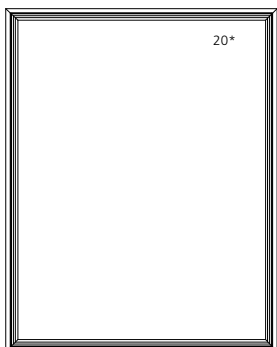

7PC6684

ELEVATION SYMBOL LEGEND:

##* NUMBER INDICATES DESIGN PRESSURE (DP) RATING WITH STANDARD GLAZING.

SCALE: 1/4" = 1'

PICTURE UNITS

UNIT SIZE
ROUGH OPENING
FRAME SIZE
DAYLIGHT OPENING

85 3/4"
84"
83 1/2"
79 29/32"

91 3/4"
90"
89 1/2"
85 29/32"

97 3/4"
96"
95 1/2"
91 29/32"

13 3/4"
12"
11 1/2"
7 29/32"



7PC8412



7PC9012



7PC9612

19 3/4"
18"
17 1/2"
13 29/32"



7PC8418



7PC9018



7PC9618

25 3/4"
24"
23 1/2"
19 29/32"



7PC8424



7PC9024



7PC9624

31 3/4"
30"
29 1/2"
25 29/32"



7PC8430



7PC9030



7PC9630

37 3/4"
36"
35 1/2"
31 29/32"



7PC8436



7PC9036



7PC9636

38 3/4"
37"
36 1/2"
32 29/32"



7PC8437



7PC9037



7PC9637

39 3/4"
38"
37 1/2"
33 29/32"



7PC8438



7PC9038



7PC9638

42 3/4"
41"
40 1/2"
36 29/32"



7PC8441



7PC9041



7PC9641

43 3/4"
42"
41 1/2"
37 29/32"



7PC8442



7PC9042



7PC9642

ELEVATION SYMBOL LEGEND:

NUMBER INDICATES DESIGN PRESSURE (DP) RATING WITH STANDARD GLAZING.

SCALE: 1/4" = 1'

PICTURE UNITS

UNIT SIZE
ROUGH OPENING
FRAME SIZE
DAYLIGHT OPENING

85 3/4"
84"
83 1/2"
79 29/32"

91 3/4"
90"
89 1/2"
85 29/32"

97 3/4"
96"
95 1/2"
91 29/32"

49 3/4"
48"
47 1/2"
43 29/32"

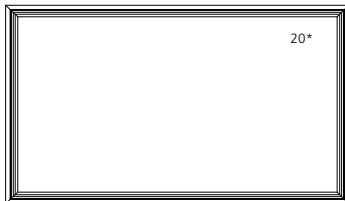

7PC8448

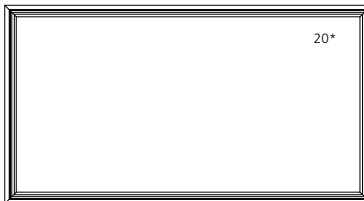

7PC9048

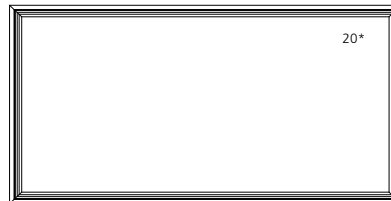

7PC9648

50 3/4"
49"
48 1/2"
44 29/32"



7PC8449

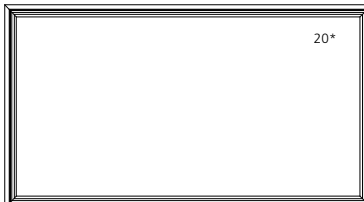

7PC9049

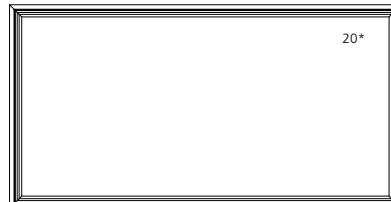

7PC9649

54 3/4"
53"
52 1/2"
48 29/32"



7PC8453

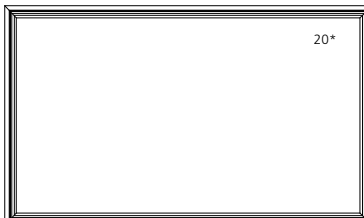

7PC9053



7PC9653

55 3/4"
54"
53 1/2"
49 29/32"

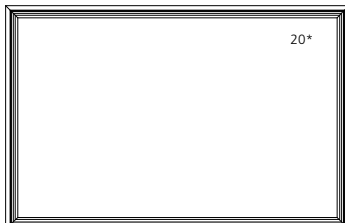

7PC8454

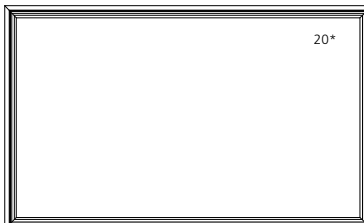

7PC9054

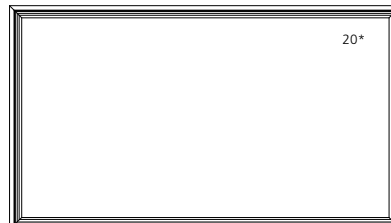

7PC9654

58 3/4"
57"
56 1/2"
52 29/32"

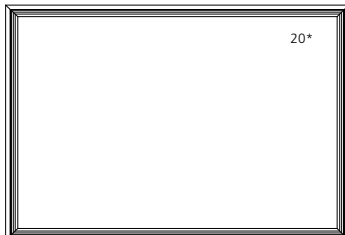

7PC8457

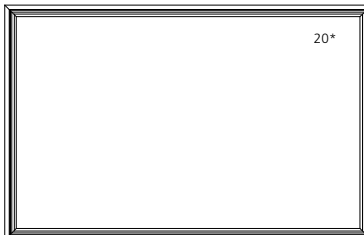

7PC9057

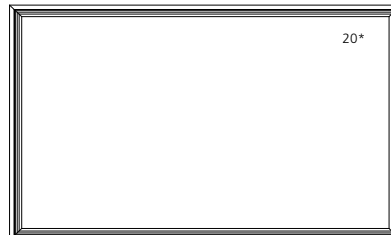

7PC9657

61 3/4"
60"
59 1/2"
55 29/32"

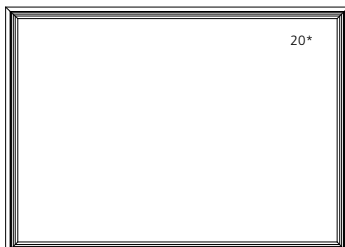

7PC8460



7PC9060



7PC9660

ELEVATION SYMBOL LEGEND:
NUMBER INDICATES DESIGN PRESSURE (DP) RATING WITH STANDARD GLAZING.

SCALE: 1/4" = 1'

PICTURE UNITS

UNIT SIZE
ROUGH OPENING
FRAME SIZE
DAYLIGHT OPENING

85 3/4"
84"
83 1/2"
79 29/32"

91 3/4"
90"
89 1/2"
85 29/32"

63 3/4"
62"
61 1/2"
59 29/32"



7PC8462



7PC9062

66 3/4"
65"
64 1/2"
60 29/32"

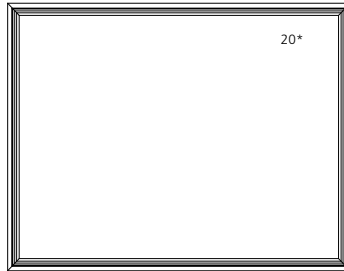

7PC8465

67 3/4"
66"
65 1/2"
61 29/32"

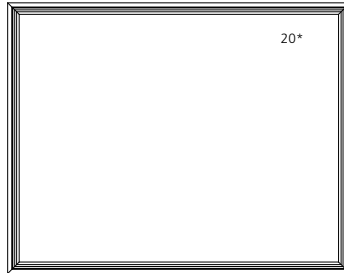

7PC8466

70 3/4"
69"
68 1/2"
64 29/32"

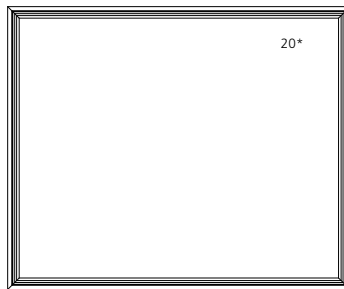







7PC8469

ELEVATION SYMBOL LEGEND:

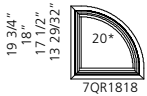
##* NUMBER INDICATES DESIGN PRESSURE (DP) RATING WITH STANDARD GLAZING.

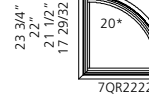
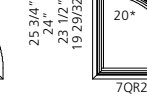
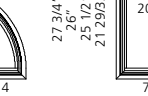
SCALE: 1/4" = 1'

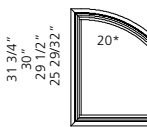
QUARTER ROUND

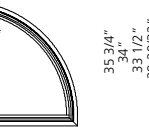
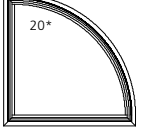
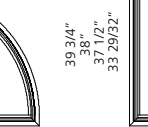
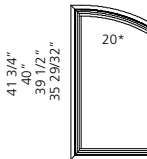
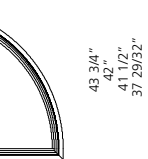
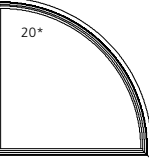
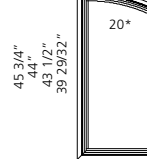
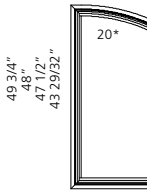
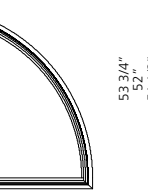
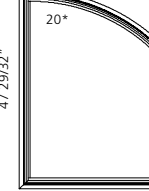
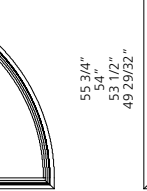
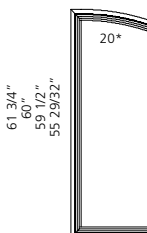
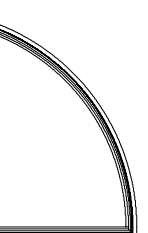
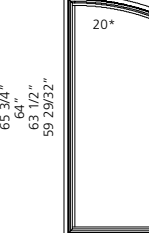
UNIT SIZE ROUGH OPENING FRAME SIZE DAYLIGHT OPENING	19 3/4" 18" 17 1/2" 13 29/32"	21 3/4" 20" 19 1/2" 15 29/32"	23 3/4" 22" 21 1/2" 17 29/32"	25 3/4" 24" 23 1/2" 19 29/32"	27 3/4" 26" 25 1/2" 21 29/32"	29 3/4" 28" 27 1/2" 23 29/32"	
	 7QR1818	 7QR2020	 7QR2222	 7QR2424	 7QR2626	 7QR2828	
UNIT SIZE ROUGH OPENING FRAME SIZE DAYLIGHT OPENING	31 3/4" 30" 29 1/2" 25 29/32"	33 3/4" 32" 31 1/2" 27 29/32"	35 3/4" 34" 33 1/2" 29 29/32"	37 3/4" 36" 35 1/2" 31 29/32"	39 3/4" 38" 37 1/2" 33 29/32"		
	 7QR3030	 7QR3232	 7QR3434	 7QR3636	 7QR3838		
UNIT SIZE ROUGH OPENING FRAME SIZE DAYLIGHT OPENING	41 3/4" 40" 39 1/2" 35 29/32"	43 3/4" 42" 41 1/2" 37 29/32"	45 3/4" 44" 43 1/2" 39 29/32"	47 3/4" 46" 45 1/2" 41 29/32"			
	 7QR4040	 7QR4242	 7QR4444	 7QR4646			
UNIT SIZE ROUGH OPENING FRAME SIZE DAYLIGHT OPENING	49 3/4" 48" 47 1/2" 43 29/32"	53 3/4" 52" 51 1/2" 47 29/32"	55 3/4" 54" 53 1/2" 49 29/32"	57 3/4" 56" 55 1/2" 51 29/32"			
	 7QR4848	 7QR5252	 7QR5454	 7QR5656			
UNIT SIZE ROUGH OPENING FRAME SIZE DAYLIGHT OPENING	61 3/4" 60" 59 1/2" 55 29/32"	65 3/4" 64" 63 1/2" 59 29/32"	67 3/4" 66" 65 1/2" 61 29/32"				
	 7QR6060	 7QR6464	 7QR6666				

ELEVATION SYMBOL LEGEND:
 *** NUMBER INDICATES DESIGN PRESSURE (DP) RATING WITH STANDARD GLAZING.

SCALE: 1/4" = 1'

QUARTER ROUND

UNIT SIZE 69 3/4"
ROUGH OPENING 68"
FRAME SIZE 67 1/2"
DAYLIGHT OPENING 63 29/32"

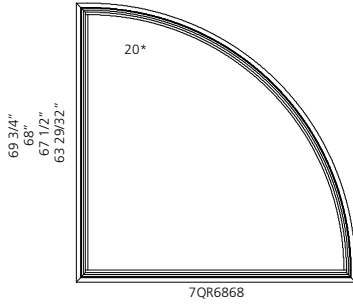

UNIT SIZE 73 3/4"
ROUGH OPENING 72"
FRAME SIZE 71 1/2"
DAYLIGHT OPENING 67 29/32"

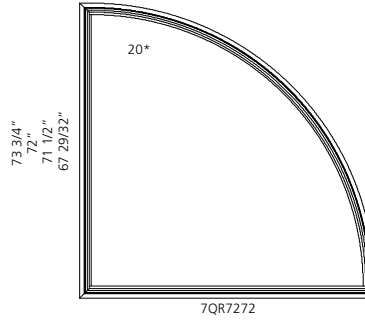

ELEVATION SYMBOL LEGEND:
NUMBER INDICATES DESIGN PRESSURE (DP) RATING WITH STANDARD GLAZING.

HALF ROUND

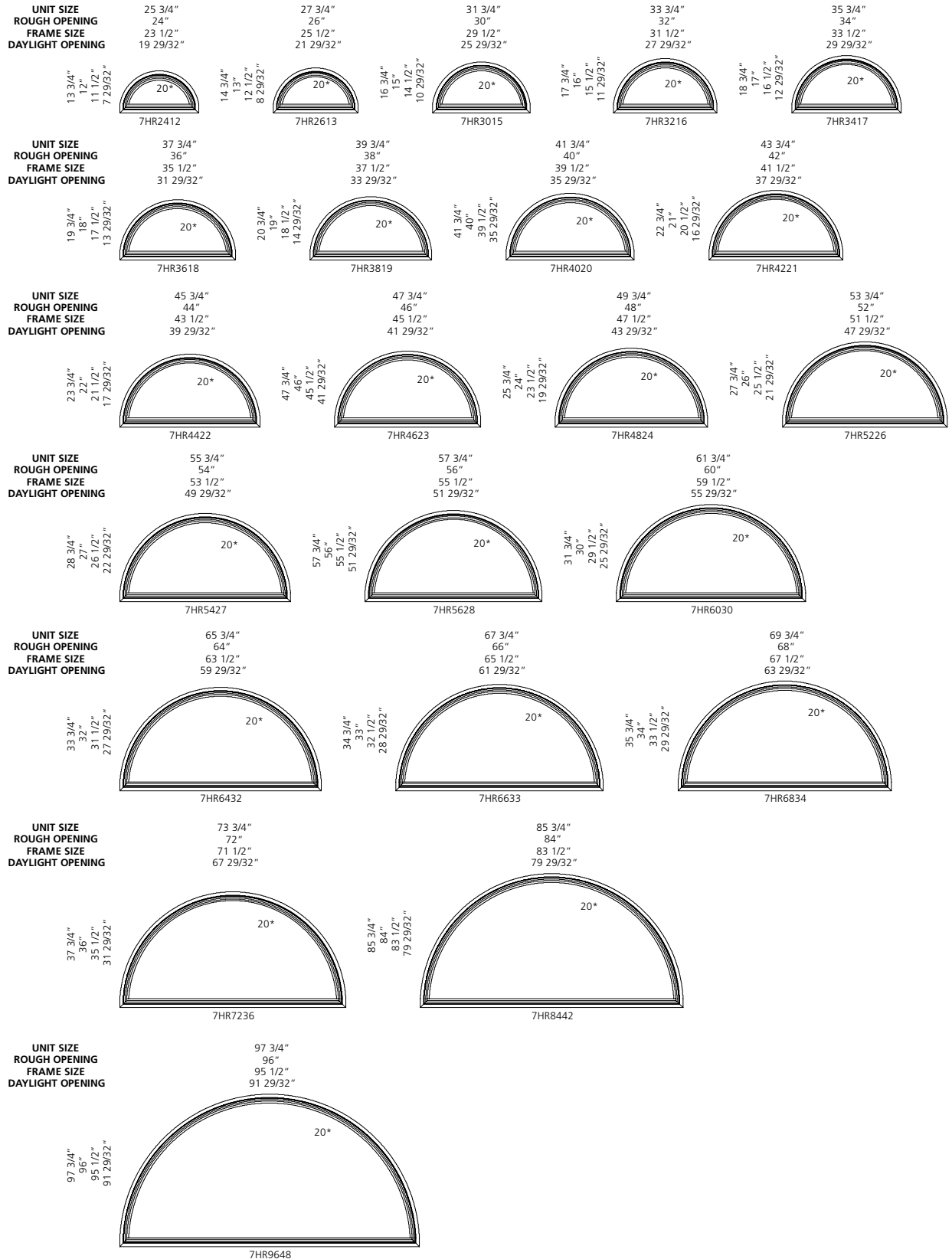

ELEVATION SYMBOL LEGEND:
 ### NUMBER INDICATES DESIGN PRESSURE (DP) RATING WITH STANDARD GLAZING.

SCALE: 1/4" = 1'

FULL ROUND

UNIT SIZE 31 3/4"
ROUGH OPENING 30"
FRAME SIZE 29 1/2"
DAYLIGHT OPENING 25 29/32"

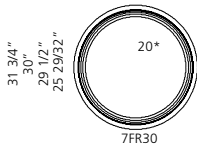

7FR30

UNIT SIZE 35 3/4"
ROUGH OPENING 34"
FRAME SIZE 33 1/2"
DAYLIGHT OPENING 29 29/32"

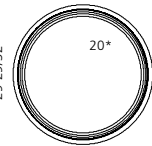

7FR34

UNIT SIZE 37 3/4"
ROUGH OPENING 36"
FRAME SIZE 35 1/2"
DAYLIGHT OPENING 31 29/32"

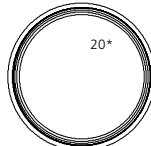

7FR36

UNIT SIZE 39 3/4"
ROUGH OPENING 38"
FRAME SIZE 37 1/2"
DAYLIGHT OPENING 33 29/32"

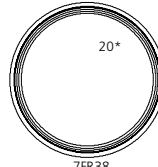

7FR38

UNIT SIZE 43 3/4"
ROUGH OPENING 42"
FRAME SIZE 41 1/2"
DAYLIGHT OPENING 37 29/32"

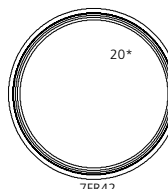

7FR42

UNIT SIZE 49 3/4"
ROUGH OPENING 48"
FRAME SIZE 47 1/2"
DAYLIGHT OPENING 43 29/32"

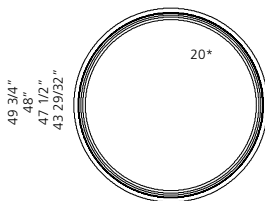

7FR48

UNIT SIZE 55 3/4"
ROUGH OPENING 54"
FRAME SIZE 53 1/2"
DAYLIGHT OPENING 49 29/32"

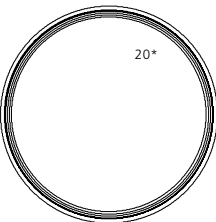

7FR54

UNIT SIZE 61 3/4"
ROUGH OPENING 60"
FRAME SIZE 59 1/2"
DAYLIGHT OPENING 55 29/32"

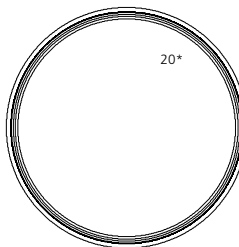

7FR60

UNIT SIZE 67 3/4"
ROUGH OPENING 66"
FRAME SIZE 65 1/2"
DAYLIGHT OPENING 61 29/32"

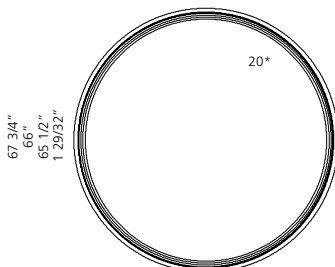

7FR66

UNIT SIZE 73 3/4"
ROUGH OPENING 72"
FRAME SIZE 71 1/2"
DAYLIGHT OPENING 67 29/32"

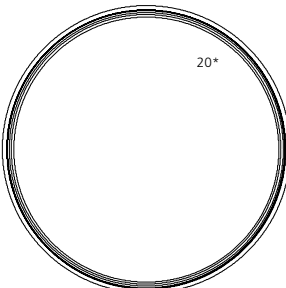

7FR72

ELEVATION SYMBOL LEGEND:
##* NUMBER INDICATES DESIGN PRESSURE (DP) RATING WITH STANDARD GLAZING.

SCALE: 1/4" = 1'

QUARTER CIRCLE SEGMENT

UNIT SIZE 25 3/4"
 ROUGH OPENING 24"
 FRAME SIZE 23 1/2"
 DAYLIGHT OPENING 19 29/32"

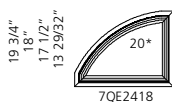

UNIT SIZE 31 3/4"
 ROUGH OPENING 30"
 FRAME SIZE 29 1/2"
 DAYLIGHT OPENING 25 29/32"

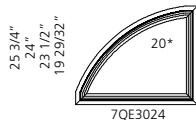

UNIT SIZE 37 3/4"
 ROUGH OPENING 36"
 FRAME SIZE 35 1/2"
 DAYLIGHT OPENING 31 29/32"

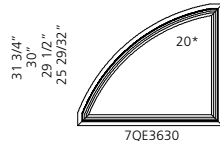

UNIT SIZE 43 3/4"
 ROUGH OPENING 42"
 FRAME SIZE 41 1/2"
 DAYLIGHT OPENING 37 29/32"

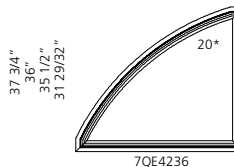

UNIT SIZE 49 3/4"
 ROUGH OPENING 48"
 FRAME SIZE 47 1/2"
 DAYLIGHT OPENING 43 29/32"

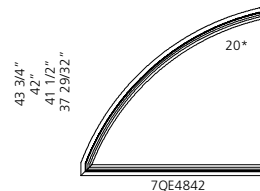

UNIT SIZE 55 3/4"
 ROUGH OPENING 54"
 FRAME SIZE 53 1/2"
 DAYLIGHT OPENING 49 29/32"

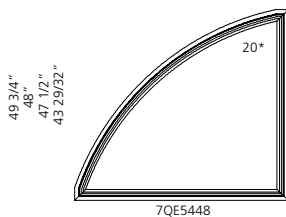

UNIT SIZE 61 3/4"
 ROUGH OPENING 60"
 FRAME SIZE 59 1/2"
 DAYLIGHT OPENING 55 29/32"

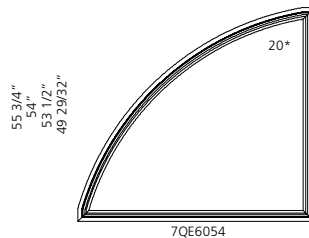

UNIT SIZE 67 3/4"
 ROUGH OPENING 66"
 FRAME SIZE 65 1/2"
 DAYLIGHT OPENING 61 29/32"

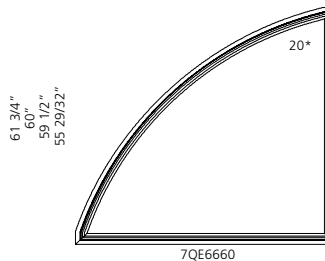

UNIT SIZE 73 3/4"
 ROUGH OPENING 72"
 FRAME SIZE 71 1/2"
 DAYLIGHT OPENING 67 29/32"

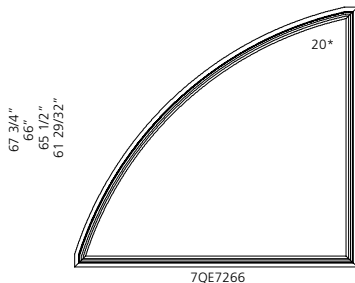

ELEVATION SYMBOL LEGEND:
 ##* NUMBER INDICATES DESIGN PRESSURE (DP) RATING WITH STANDARD GLAZING.

SCALE: 1/4" = 1'

CIRCLE SEGMENT

UNIT SIZE 31 3/4"
ROUGH OPENING 30"
FRAME SIZE 29 1/2"
DAYLIGHT OPENING 25 29/32"

13 3/4"
12"
11 1/2"
7 29/32"

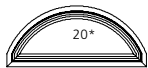

7EY3012

UNIT SIZE 37 3/4"
ROUGH OPENING 36"
FRAME SIZE 35 1/2"
DAYLIGHT OPENING 31 29/32"

13 3/4"
13"
11 1/2"
7 29/32"



7EY3612

UNIT SIZE 43 3/4"
ROUGH OPENING 42"
FRAME SIZE 41 1/2"
DAYLIGHT OPENING 37 29/32"

19 3/4"
18"
17 1/2"
13 29/32"

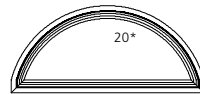

7EY4218

UNIT SIZE 49 3/4"
ROUGH OPENING 48"
FRAME SIZE 47 1/2"
DAYLIGHT OPENING 43 29/32"

19 3/4"
18"
17 1/2"
13 29/32"

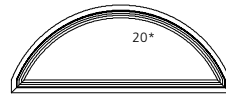

7EY4818

UNIT SIZE 55 3/4"
ROUGH OPENING 54"
FRAME SIZE 53 1/2"
DAYLIGHT OPENING 49 29/32"

25 3/4"
24"
23 1/2"
19 29/32"

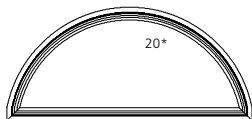

7EY5424

UNIT SIZE 61 3/4"
ROUGH OPENING 60"
FRAME SIZE 59 1/2"
DAYLIGHT OPENING 55 29/32"

25 3/4"
24"
23 1/2"
19 29/32"

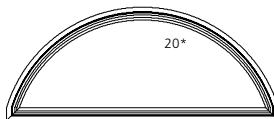

7EY6024

UNIT SIZE 67 3/4"
ROUGH OPENING 66"
FRAME SIZE 65 1/2"
DAYLIGHT OPENING 61 29/32"

31 3/4"
30"
29 1/2"
25 29/32"

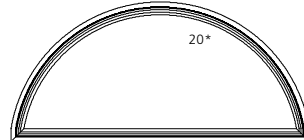

7EY6630

UNIT SIZE 73 3/4"
ROUGH OPENING 72"
FRAME SIZE 71 1/2"
DAYLIGHT OPENING 67 29/32"

31 3/4"
30"
29 1/2"
25 29/32"

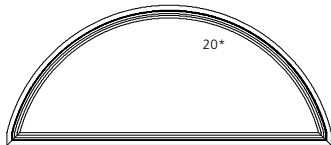

7EY7230

ELEVATION SYMBOL LEGEND:
##* NUMBER INDICATES DESIGN PRESSURE (DP) RATING WITH STANDARD GLAZING.

SCALE: 1/4" = 1'

OVAL

UNIT SIZE 25 3/4"
ROUGH OPENING 24"
FRAME SIZE 23 1/2"
DAYLIGHT OPENING 19 29/32"

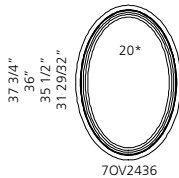

70V2436

UNIT SIZE 31 3/4"
ROUGH OPENING 30"
FRAME SIZE 29 1/2"
DAYLIGHT OPENING 25 29/32"

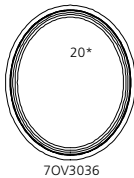

70V3036

UNIT SIZE 31 3/4"
ROUGH OPENING 30"
FRAME SIZE 29 1/2"
DAYLIGHT OPENING 25 29/32"

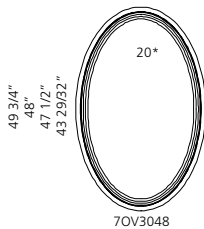

70V3048

UNIT SIZE 33 3/4"
ROUGH OPENING 32"
FRAME SIZE 31 1/2"
DAYLIGHT OPENING 27 29/32"

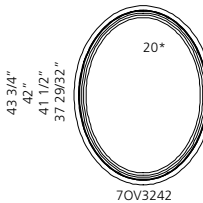

70V3242

UNIT SIZE 37 3/4"
ROUGH OPENING 36"
FRAME SIZE 35 1/2"
DAYLIGHT OPENING 31 29/32"

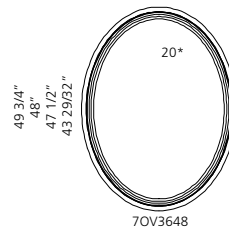

70V3648

UNIT SIZE 37 3/4"
ROUGH OPENING 36"
FRAME SIZE 35 1/2"
DAYLIGHT OPENING 31 29/32"

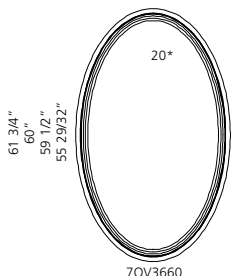

70V3660

ELEVATION SYMBOL LEGEND:

##* NUMBER INDICATES DESIGN PRESSURE (DP) RATING WITH STANDARD GLAZING.

SCALE: 1/4" = 1'



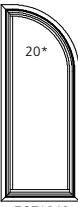
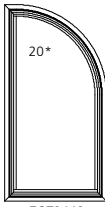
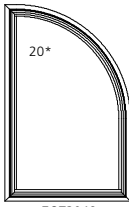
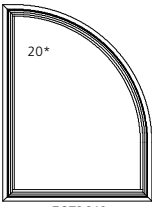
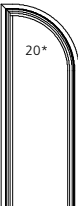
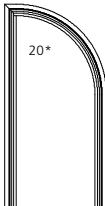
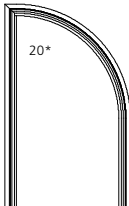
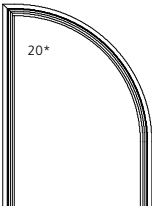
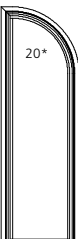
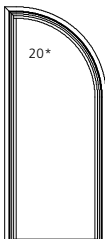
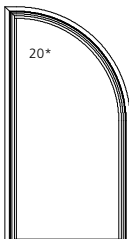
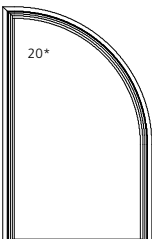
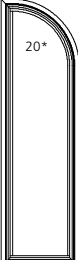
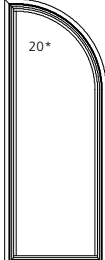
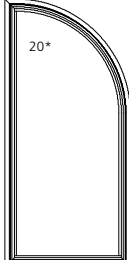
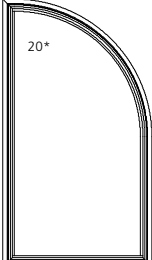
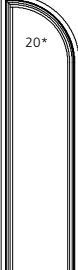
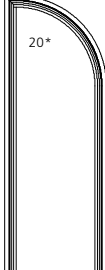
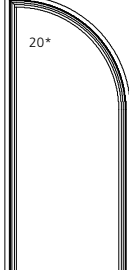
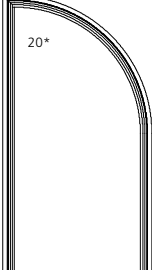







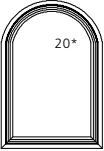
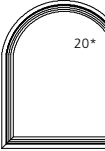
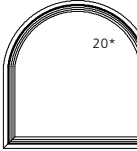
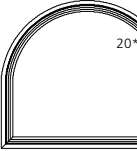
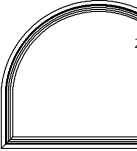

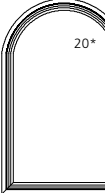
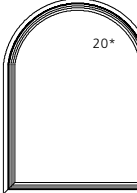
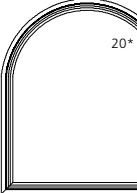
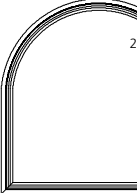
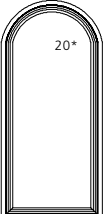
EXTENDED QUARTER ROUND

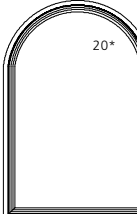
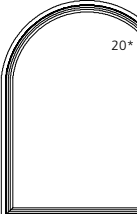
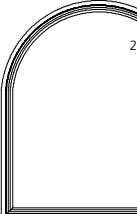
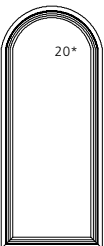
	UNIT SIZE 19 3/4"	25 3/4"	31 3/4"	37 3/4"
ROUGH OPENING	18"	24"	30"	36"
FRAME SIZE	17 1/2"	23 1/2"	29 1/2"	35 1/2"
DAYLIGHT OPENING	13 29/32"	19 29/32"	25 29/32"	31 29/32"
49 3/4" 48" 47 1/2" 43 29/32"	20*  7QT1848	20*  7QT2448	20*  7QT3048	20*  7QT3648
55 3/4" 54" 53 1/2" 49 29/32"	20*  7QT1854	20*  7QT2454	20*  7QT3054	20*  7QT3654
61 3/4" 60" 59 1/2" 55 29/32"	20*  7QT1860	20*  7QT2460	20*  7QT3060	20*  7QT3660
67 3/4" 66" 65 1/2" 61 29/32"	20*  7QT1866	20*  7QT2466	20*  7QT3066	20*  7QT3666
73 3/4" 72" 71 1/2" 67 29/32"	20*  7QT1872	20*  7QT2472	20*  7QT3072	20*  7QT3672

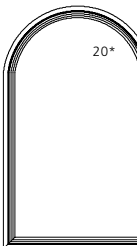
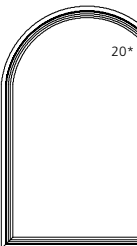
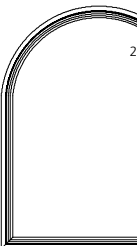
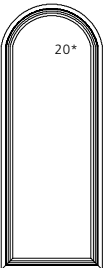
ELEVATION SYMBOL LEGEND:
##* NUMBER INDICATES DESIGN PRESSURE (DP) RATING WITH STANDARD GLAZING.

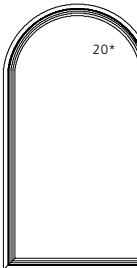
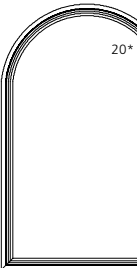
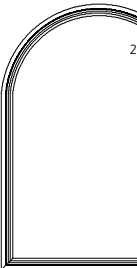
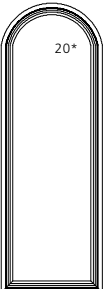
SCALE: 1/4" = 1'

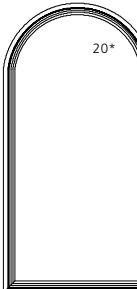

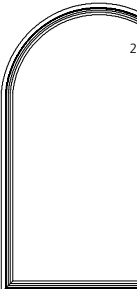

EXTENDED HALF ROUND

UNIT SIZE	25 3/4"	31 3/4"	37 3/4"	43 3/4"	49 3/4"
ROUGH OPENING	24"	30"	36"	42"	48"
FRAME SIZE	23 1/2"	29 1/2"	35 1/2"	41 1/2"	47 1/2"
DAYLIGHT OPENING	19 29/32"	25 29/32"	31 29/32"	37 29/32"	43 29/32"
37 3/4" 36" 35 1/2" 31 29/32"	 20* 75L2436	 20* 75L3036	 20* 75L3636	 20* 75L4236	 20* 75L4836
49 3/4" 48" 47 1/2" 43 29/32"	 20* 75L2448	 20* 75L3048	 20* 75L3648	 20* 75L4248	 20* 75L4848
55 3/4" 54" 53 1/2" 49 29/32"	 20* 75L2454	 20* 75L3054	 20* 75L3654	 20* 75L4254	 20* 75L4854
61 3/4" 60" 59 1/2" 55 29/32"	 20* 75L2460	 20* 75L3060	 20* 75L3660	 20* 75L4260	 20* 75L4860
67 3/4" 66" 65 1/2" 61 29/32"	 20* 75L2466	 20* 75L3066	 20* 75L3666	 20* 75L4266	 20* 75L4866
73 3/4" 72" 71 1/2" 67 29/32"	 20* 75L2472	 20* 75L3072	 20* 75L3672	 20* 75L4272	 20* 75L4872

ELEVATION SYMBOL LEGEND:
##* NUMBER INDICATES DESIGN PRESSURE (DP) RATING WITH STANDARD GLAZING.

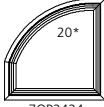
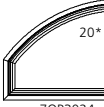
SCALE: 1/4" = 1'

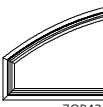
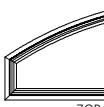
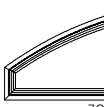
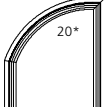
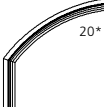
EXTENDED QUARTER SEGMENT

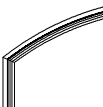
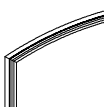
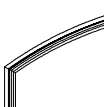
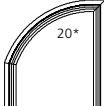
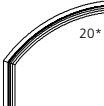
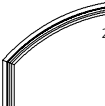
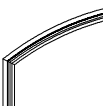
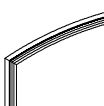
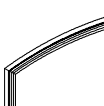
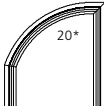
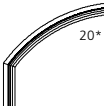
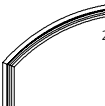
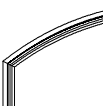
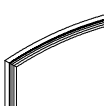
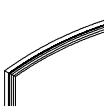
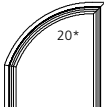
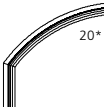
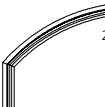
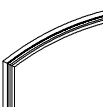
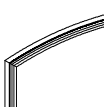
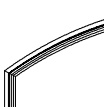
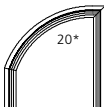
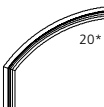
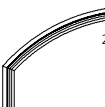
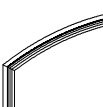
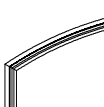
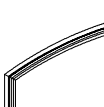
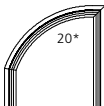
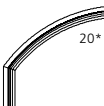
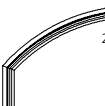
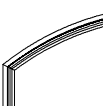
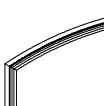
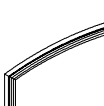
UNIT SIZE ROUGH OPENING FRAME SIZE DAYLIGHT OPENING	25 3/4" 24" 23 1/2" 19 29/32"	31 3/4" 30" 29 1/2" 25 29/32"	37 3/4" 36" 35 1/2" 31 29/32"	43 3/4" 42" 41 1/2" 37 29/32"	49 3/4" 48" 47 1/2" 43 29/32"	55 3/4" 54" 53 1/2" 49 29/32"
25 3/4" 24" 23 1/2" 19 29/32"	 20*	 20*	 20*	 20*	 20*	 20*
31 3/4" 30" 29 1/2" 25 29/32"	 20*	 20*	 20*	 20*	 20*	 20*
37 3/4" 36" 35 1/2" 31 29/32"	 20*	 20*	 20*	 20*	 20*	 20*
43 3/4" 42" 41 1/2" 37 29/32"	 20*	 20*	 20*	 20*	 20*	 20*
49 3/4" 48" 47 1/2" 43 29/32"	 20*	 20*	 20*	 20*	 20*	 20*
55 3/4" 54" 53 1/2" 49 29/32"	 20*	 20*	 20*	 20*	 20*	 20*
61 3/4" 60" 59 1/2" 55 29/32"	 20*	 20*	 20*	 20*	 20*	 20*

ELEVATION SYMBOL LEGEND:
 ##* NUMBER INDICATES DESIGN PRESSURE (DP) RATING WITH STANDARD GLAZING.

SCALE: 1/4" = 1'

EXTENDED QUARTER SEGMENT

UNIT SIZE	25 3/4"	31 3/4"	37 3/4"	43 3/4"	49 3/4"	55 3/4"
ROUGH OPENING	24"	30"	36"	42"	48"	54"
FRAME SIZE	23 1/2"	29 1/2"	35 1/2"	41 1/2"	47 1/2"	53 1/2"
DAYLIGHT OPENING	19 29/32"	25 29/32"	31 29/32"	37 29/32"	43 29/32"	49 29/32"

67 3/4"						
	20*	20*	20*	20*	20*	20*
	66"	65 1/2"	61 29/32"			
	7QP2466	7QP3066	7QP3666	7QP4266	7QP4866	7QP5466
73 3/4"						
	20*	20*	20*	20*	20*	20*
	72"	71 1/2"	67 29/32"			
	7QP2472	7QP3072	7QP3672	7QP4272	7QP4872	7QP5472

ELEVATION SYMBOL LEGEND:
##* NUMBER INDICATES DESIGN PRESSURE (DP) RATING WITH STANDARD GLAZING.

SCALE: 1/4" = 1'

EXTENDED QUARTER SEGMENT

UNIT SIZE
ROUGH OPENING
FRAME SIZE
DAYLIGHT OPENING

61 3/4"
60"
59 1/2"
55 29/32"

67 3/4"
66"
65 1/2"
61 29/32"

73 3/4"
72"
71 1/2"
67 29/32"

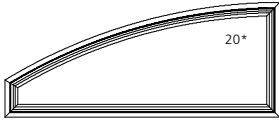
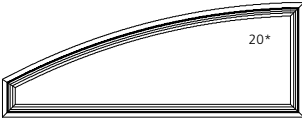
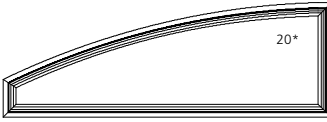
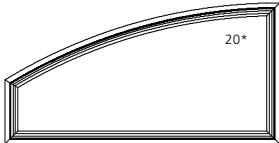
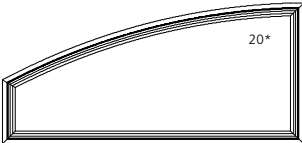
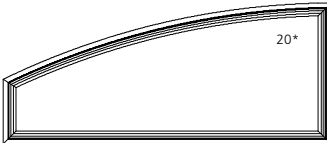
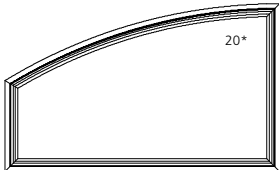
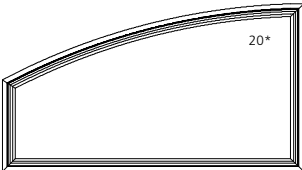
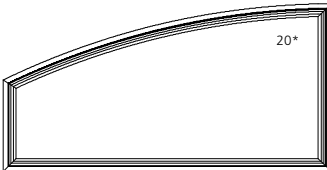
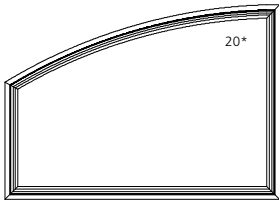
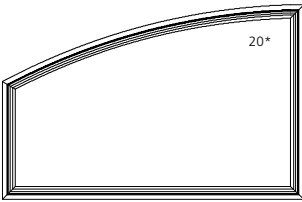
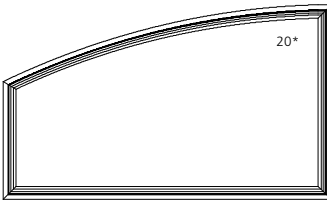
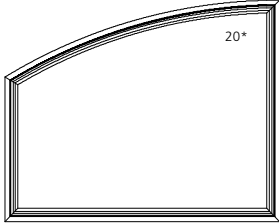
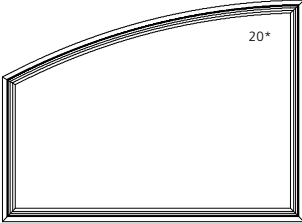
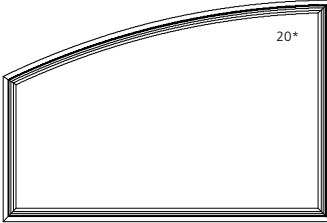
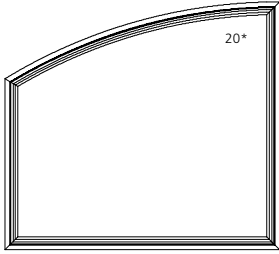
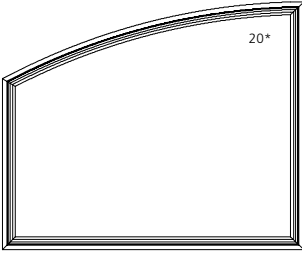
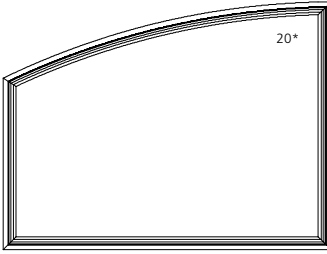
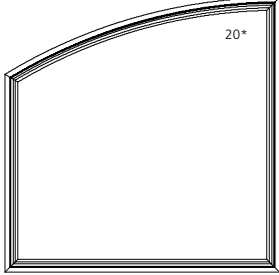
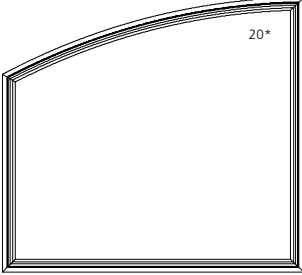
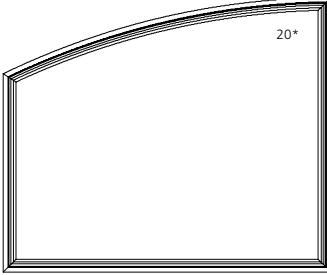
25 3/4" 24" 23 1/2" 19 29/32"	 20*	 20*	 20*
31 3/4" 30" 29 1/2" 25 29/32"	 20*	 20*	 20*
37 3/4" 36" 35 1/2" 31 29/32"	 20*	 20*	 20*
43 3/4" 42" 41 1/2" 37 29/32"	 20*	 20*	 20*
49 3/4" 48" 47 1/2" 43 29/32"	 20*	 20*	 20*
55 3/4" 54" 53 1/2" 49 29/32"	 20*	 20*	 20*
61 3/4" 60" 59 1/2" 55 29/32"	 20*	 20*	 20*

ELEVATION SYMBOL LEGEND:
NUMBER INDICATES DESIGN PRESSURE (DP) RATING WITH STANDARD GLAZING.

SCALE: 1/4" = 1'

EXTENDED QUARTER SEGMENT



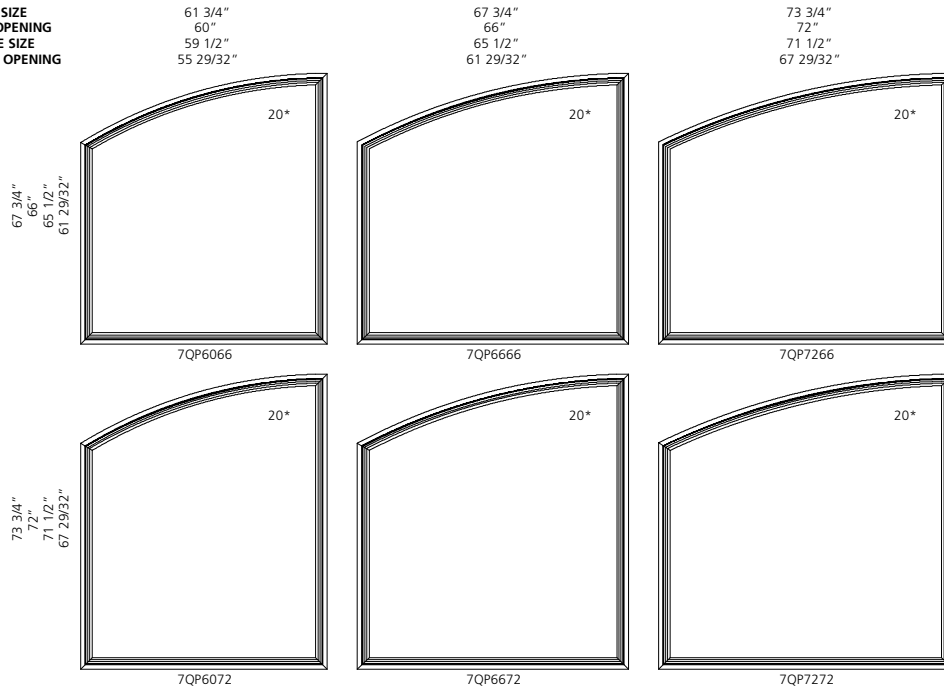





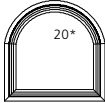
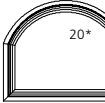
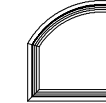
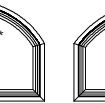
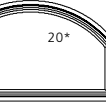
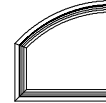
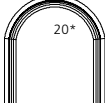
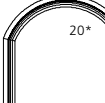
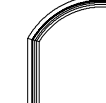
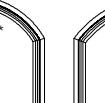
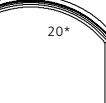
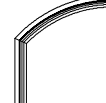
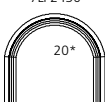
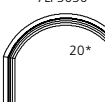

UNIT SIZE
ROUGH OPENING
FRAME SIZE
DAYLIGHT OPENING

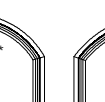
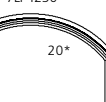
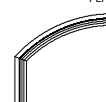
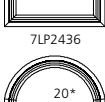
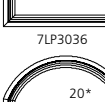
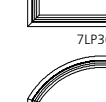
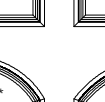
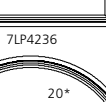
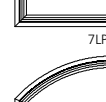
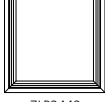

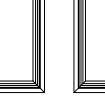
ELEVATION SYMBOL LEGEND:
NUMBER INDICATES DESIGN PRESSURE (DP) RATING WITH STANDARD GLAZING.

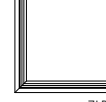
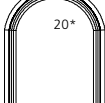
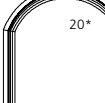
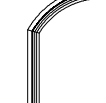
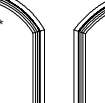
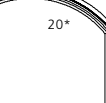
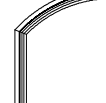
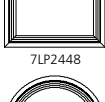
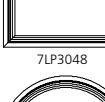
SCALE: 1/4" = 1'

EXTENDED CIRCLE SEGMENT

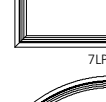
UNIT SIZE	25 3/4"	31 3/4"	37 3/4"	43 3/4"	49 3/4"	55 3/4"
ROUGH OPENING	24"	30"	36"	42"	48"	54"
FRAME SIZE	23 1/2"	29 1/2"	35 1/2"	41 1/2"	47 1/2"	53 1/2"
DAYLIGHT OPENING	19 29/32"	25 29/32"	31 29/32"	37 29/32"	43 29/32"	49 29/32"
25 3/4" 24" 23 1/2" 19 29/32"	 20* 7LP2424	 20* 7LP3024	 20* 7LP3624	 20* 7LP4224	 20* 7LP4824	 20* 7LP5424
31 3/4" 30" 29 1/2" 25 29/32"	 20* 7LP2430	 20* 7LP3030	 20* 7LP3630	 20* 7LP4230	 20* 7LP4830	 20* 7LP5430
37 3/4" 36" 35 1/2" 31 29/32"	 20* 7LP2436	 20* 7LP3036	 20* 7LP3636	 20* 7LP4236	 20* 7LP4836	 20* 7LP5436
43 3/4" 42" 41 1/2" 37 29/32"	 20* 7LP2442	 20* 7LP3042	 20* 7LP3642	 20* 7LP4242	 20* 7LP4842	 20* 7LP5442
49 3/4" 48" 47 1/2" 43 29/32"	 20* 7LP2448	 20* 7LP3048	 20* 7LP3648	 20* 7LP4248	 20* 7LP4848	 20* 7LP5448
55 3/4" 54" 53 1/2" 49 29/32"	 20* 7LP2454	 20* 7LP3054	 20* 7LP3654	 20* 7LP4254	 20* 7LP4854	 20* 7LP5454
61 3/4" 60" 59 1/2" 55 29/32"	 20* 7LP2460	 20* 7LP3060	 20* 7LP3660	 20* 7LP4260	 20* 7LP4860	 20* 7LP5460

ELEVATION SYMBOL LEGEND:
 ##* NUMBER INDICATES DESIGN PRESSURE (DP) RATING WITH STANDARD GLAZING.

SCALE: 1/4" = 1'

EXTENDED CIRCLE SEGMENT

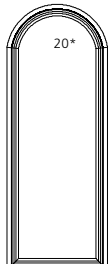
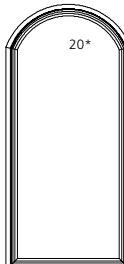
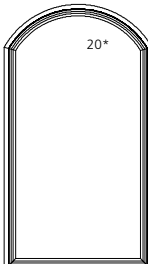
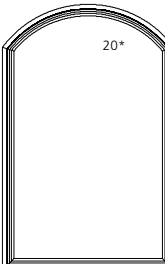
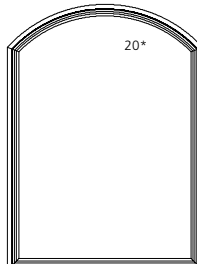
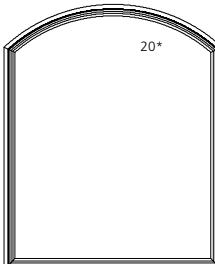
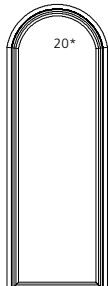
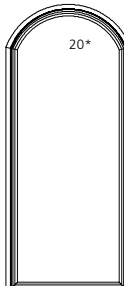
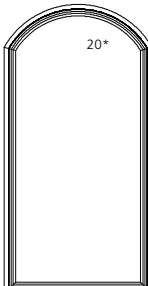
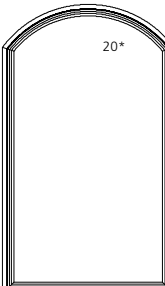
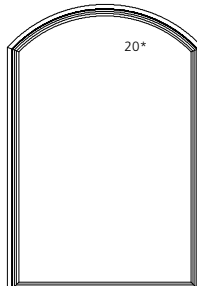
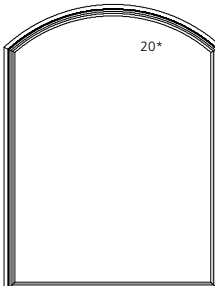

	25 3/4"	31 3/4"	37 3/4"	43 3/4"	49 3/4"	55 3/4"
UNIT SIZE	25 3/4"	31 3/4"	37 3/4"	43 3/4"	49 3/4"	55 3/4"
ROUGH OPENING	24"	30"	36"	42"	48"	54"
FRAME SIZE	23 1/2"	29 1/2"	35 1/2"	41 1/2"	47 1/2"	53 1/2"
DAYLIGHT OPENING	19 29/32"	25 29/32"	31 29/32"	37 29/32"	43 29/32"	49 29/32"

67 3/4" 66" 65 1/2" 61 29/32"						
	20*	20*	20*	20*	20*	20*
	7LP2466	7LP3066	7LP3666	7LP4266	7LP4866	7LP5466
73 3/4" 72" 71 1/2" 67 29/32"						
	20*	20*	20*	20*	20*	20*
	7LP2472	7LP3072	7LP3672	7LP4272	7LP4872	7LP5472

ELEVATION SYMBOL LEGEND:
##* NUMBER INDICATES DESIGN PRESSURE (DP) RATING WITH STANDARD GLAZING.

SCALE: 1/4" = 1'

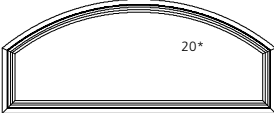
EXTENDED CIRCLE SEGMENT

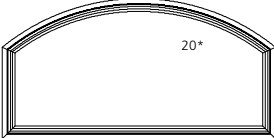
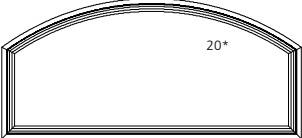
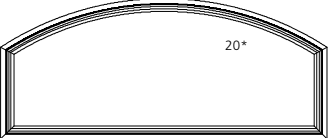
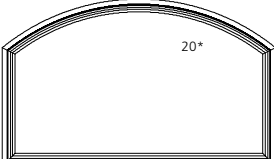
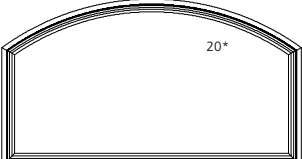
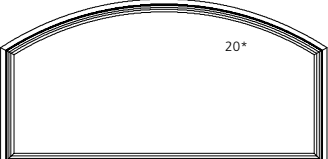
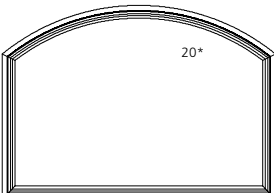
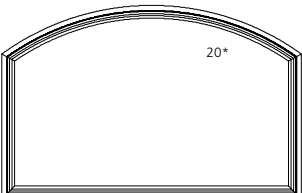
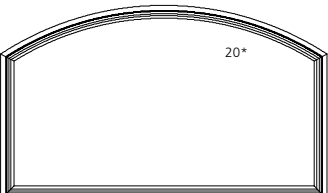
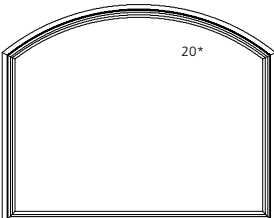
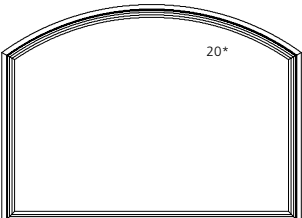
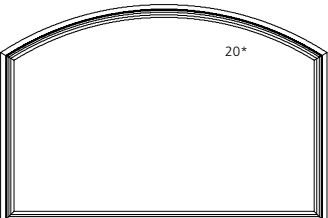
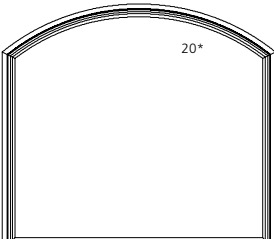
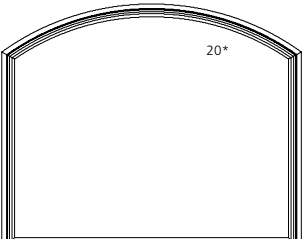
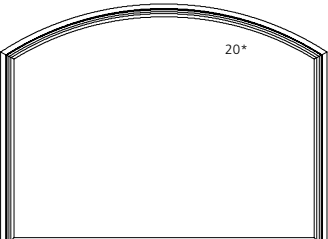
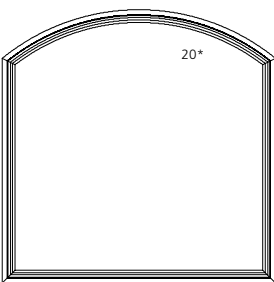
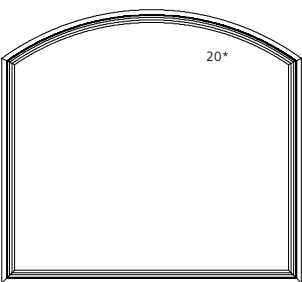
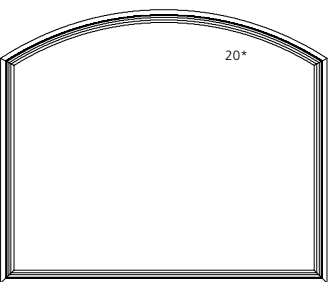
UNIT SIZE	61 3/4"	67 3/4"	73 3/4"
ROUGH OPENING	60"	66"	72"
FRAME SIZE	59 1/2"	65 1/2"	71 1/2"
DAYLIGHT OPENING	55 29/32"	61 29/32"	67 29/32"
25 3/4" 24" 23 1/2" 19 29/32"	 20*	 20*	 20*
	7LP6024	7LP6624	7LP7224
31 3/4" 30" 29 1/2" 25 29/32"	 20*	 20*	 20*
	7LP6030	7LP6630	7LP7230
37 3/4" 36" 35 1/2" 31 29/32"	 20*	 20*	 20*
	7LP6036	7LP6636	7LP7236
43 3/4" 42" 41 1/2" 37 29/32"	 20*	 20*	 20*
	7LP6042	7LP6642	7LP7242
49 3/4" 48" 47 1/2" 43 29/32"	 20*	 20*	 20*
	7LP6048	7LP6648	7LP7248
55 3/4" 54" 53 1/2" 49 29/32"	 20*	 20*	 20*
	7LP6054	7LP6654	7LP7254
61 3/4" 60" 59 1/2" 55 29/32"	 20*	 20*	 20*
	7LP6060	7LP6660	7LP7260

ELEVATION SYMBOL LEGEND:
##* NUMBER INDICATES DESIGN PRESSURE (DP) RATING WITH STANDARD GLAZING.

SCALE: 1/4" = 1'

EXTENDED CIRCLE SEGMENT

UNIT SIZE
ROUGH OPENING
FRAME SIZE
DAYLIGHT OPENING

61 3/4"
60"
59 1/2"
55 29/32"

67 3/4"
66"
65 1/2"
61 29/32"

73 3/4"
72"
71 1/2"
67 29/32"

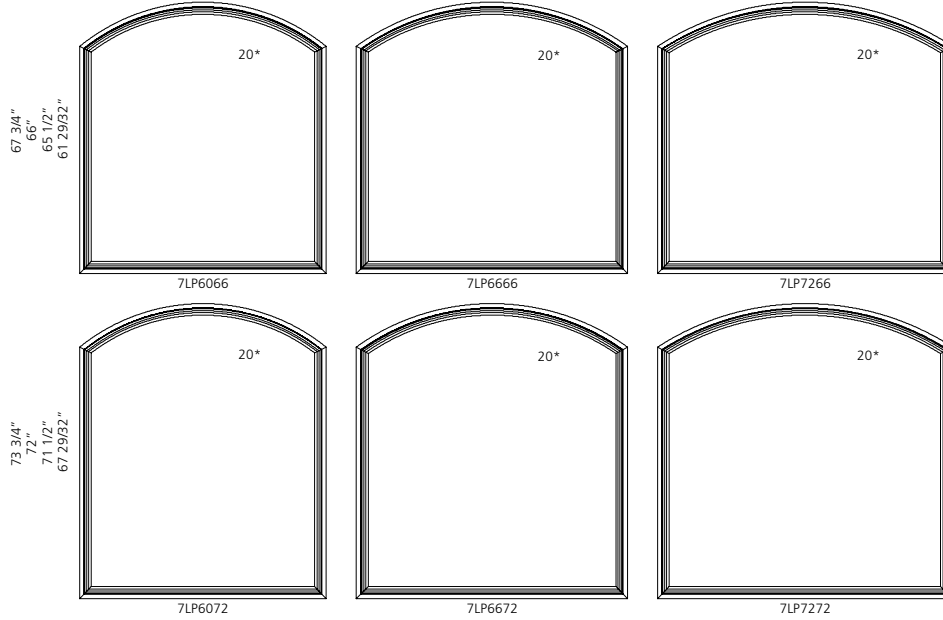

ELEVATION SYMBOL LEGEND:
NUMBER INDICATES DESIGN PRESSURE (DP) RATING WITH STANDARD GLAZING.

SCALE: 1/4" = 1'

TRAPEZOID

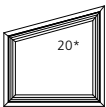
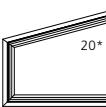
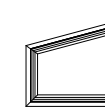
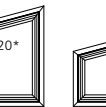
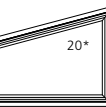
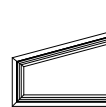
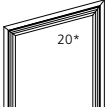
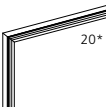
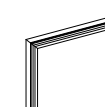
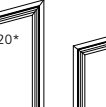
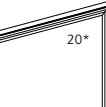
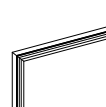
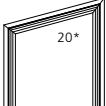
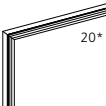
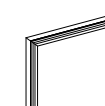
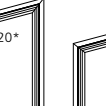
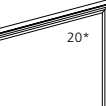
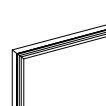
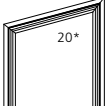
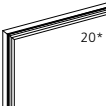
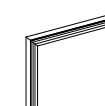
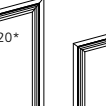
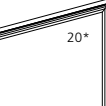
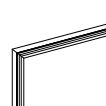
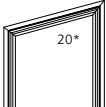
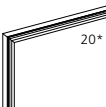
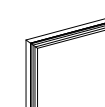
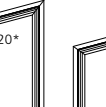
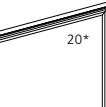
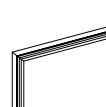
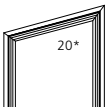
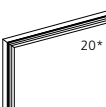
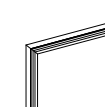
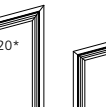
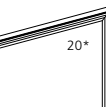
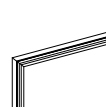
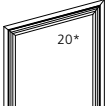
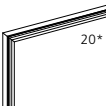
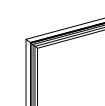
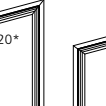
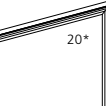
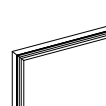
UNIT SIZE ROUGH OPENING FRAME SIZE DAYLIGHT OPENING	25 3/4" 24" 23 1/2" 19 29/32"	31 3/4" 30" 29 1/2" 25 29/32"	37 3/4" 36" 35 1/2" 31 29/32"	43 3/4" 42" 41 1/2" 37 29/32"	49 3/4" 48" 47 1/2" 43 29/32"	55 3/4" 54" 53 1/2" 49 29/32"
25 3/4" 24" 23 1/2" 19 29/32"	 20* 7PCA2424	 20* 7PCA3024	 20* 7PCA3624	 20* 7PCA4224	 20* 7PCA4824	 20* 7PCA5424
31 3/4" 30" 29 1/2" 25 29/32"	 20* 7PCA2430	 20* 7PCA3030	 20* 7PCA3630	 20* 7PCA4230	 20* 7PCA4830	 20* 7PCA5430
37 3/4" 36" 35 1/2" 31 29/32"	 20* 7PCA2436	 20* 7PCA3036	 20* 7PCA3636	 20* 7PCA4236	 20* 7PCA4836	 20* 7PCA5436
43 3/4" 42" 41 1/2" 37 29/32"	 20* 7PCA2442	 20* 7PCA3042	 20* 7PCA3642	 20* 7PCA4242	 20* 7PCA4842	 20* 7PCA5442
49 3/4" 48" 47 1/2" 43 29/32"	 20* 7PCA2448	 20* 7PCA3048	 20* 7PCA3648	 20* 7PCA4248	 20* 7PCA4848	 20* 7PCA5448
55 3/4" 54" 53 1/2" 49 29/32"	 20* 7PCA2454	 20* 7PCA3054	 20* 7PCA3654	 20* 7PCA4254	 20* 7PCA4854	 20* 7PCA5454
61 3/4" 60" 59 1/2" 55 29/32"	 20* 7PCA2460	 20* 7PCA3060	 20* 7PCA3660	 20* 7PCA4260	 20* 7PCA4860	 20* 7PCA5460

ELEVATION SYMBOL LEGEND:
##* NUMBER INDICATES DESIGN PRESSURE (DP) RATING WITH STANDARD GLAZING.

SCALE: 1/4" = 1'

TRAPEZOID

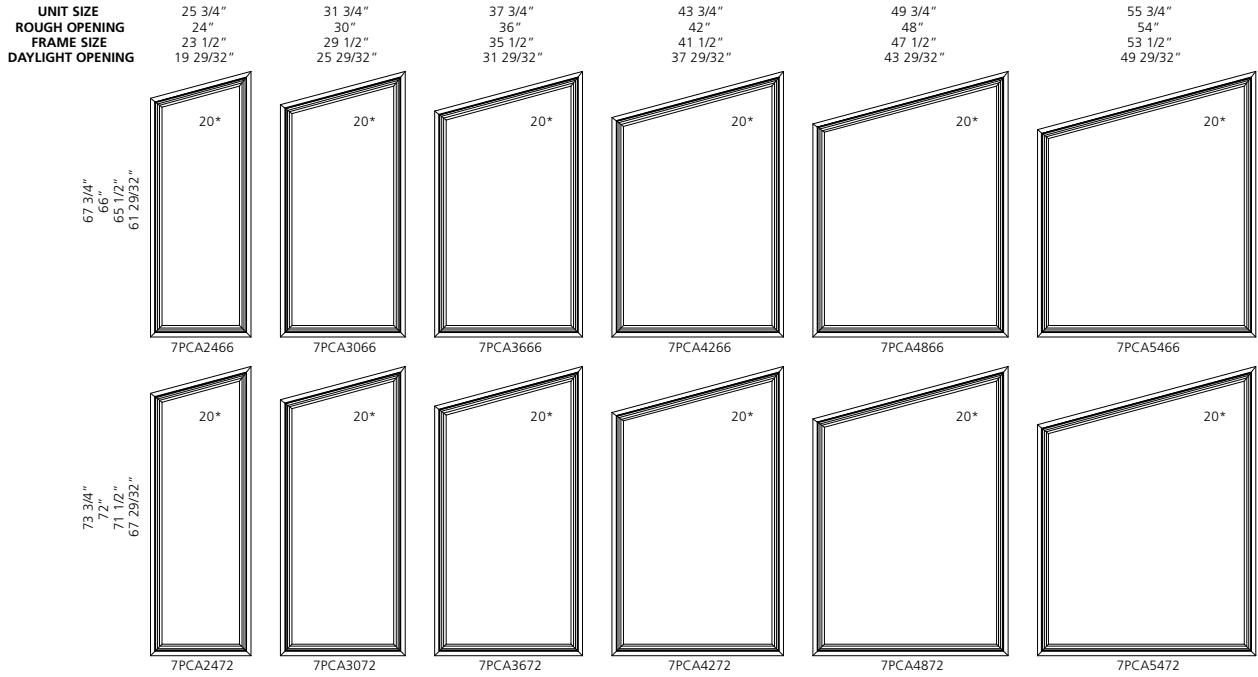

ELEVATION SYMBOL LEGEND:
NUMBER INDICATES DESIGN PRESSURE (DP) RATING WITH STANDARD GLAZING.

SCALE: 1/4" = 1'



TRAPEZOID

UNIT SIZE
ROUGH OPENING
FRAME SIZE
DAYLIGHT OPENING

61 3/4"
60"
59 1/2"
55 29/32"

67 3/4"
66"
65 1/2"
61 29/32"

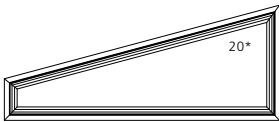
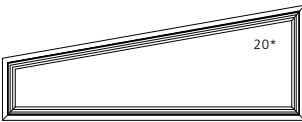
73 3/4"
72"
71 1/2"
67 29/32"

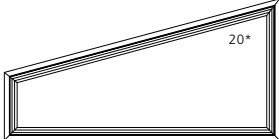
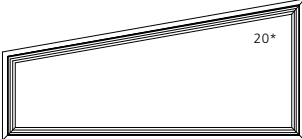
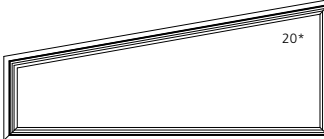
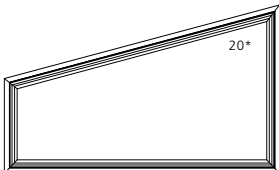
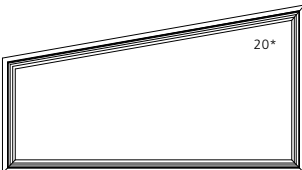
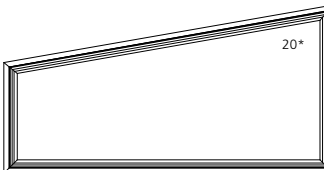
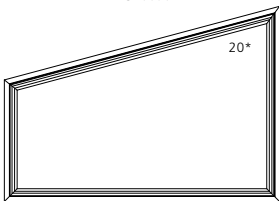
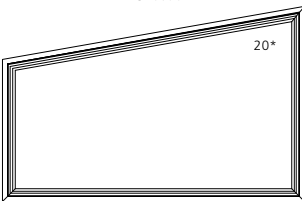
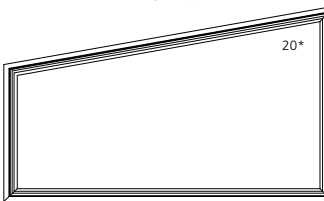
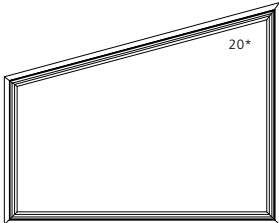
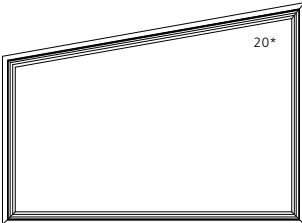
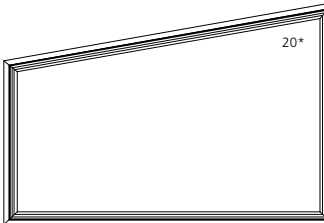
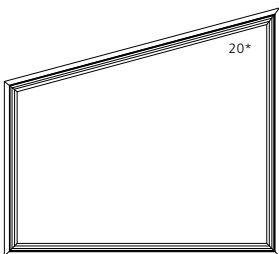
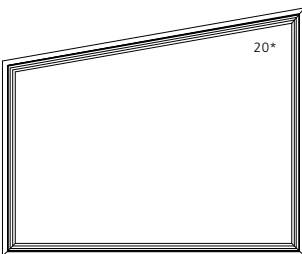
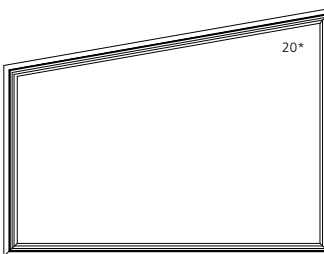
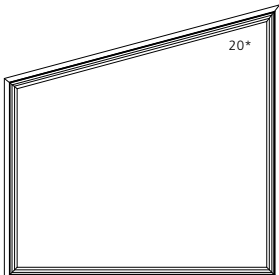
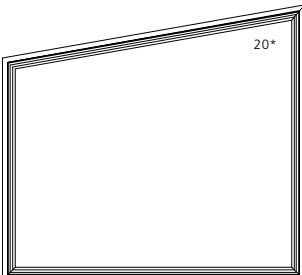
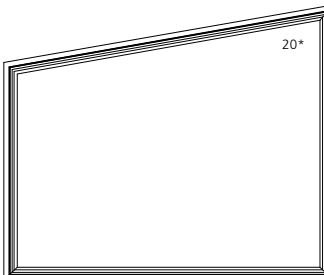
25 3/4" 24" 23 1/2" 19 29/32"			
31 3/4" 30" 29 1/2" 25 29/32"			
37 3/4" 36" 35 1/2" 31 29/32"			
43 3/4" 42" 41 1/2" 37 29/32"			
49 3/4" 48" 47 1/2" 43 29/32"			
55 3/4" 54" 53 1/2" 49 29/32"			
61 3/4" 60" 59 1/2" 55 29/32"			

ELEVATION SYMBOL LEGEND:

##* NUMBER INDICATES DESIGN PRESSURE (DP) RATING WITH STANDARD GLAZING.

SCALE: 1/4" = 1'

TRAPEZOID

UNIT SIZE
ROUGH OPENING
FRAME SIZE
DAYLIGHT OPENING

61 3/4"
60"
59 1/2"
55 29/32"

67 3/4"
66"
65 1/2"
61 29/32"

73 3/4"
72"
71 1/2"
67 29/32"

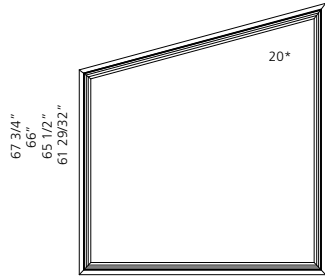

7PCA6066

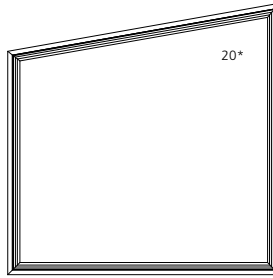

7PCA6666

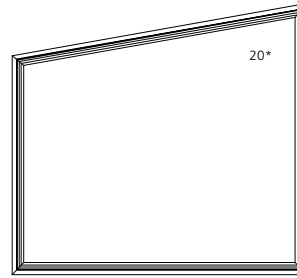

7PCA7266

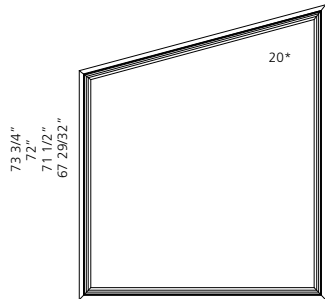

7PCA6072

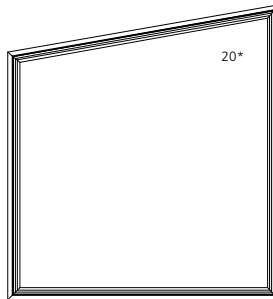

7PCA6672

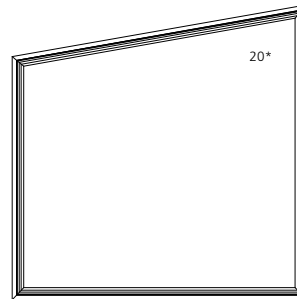











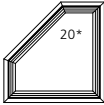
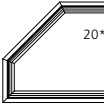
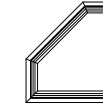
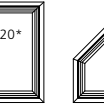
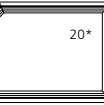
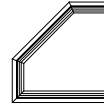
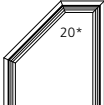
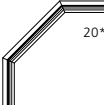

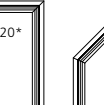
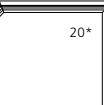
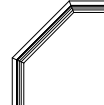
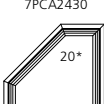
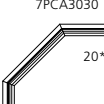
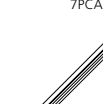

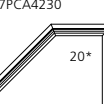

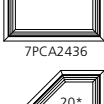
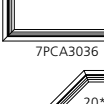

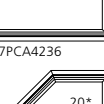
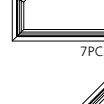
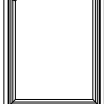

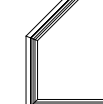
7PCA7272

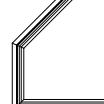
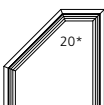
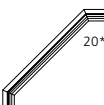
ELEVATION SYMBOL LEGEND:

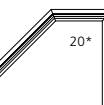
##* NUMBER INDICATES DESIGN PRESSURE (DP) RATING WITH STANDARD GLAZING.

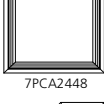
SCALE: 1/4" = 1'

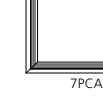
CLIPPED CORNER

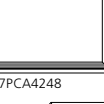
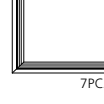
UNIT SIZE	25 3/4"	31 3/4"	37 3/4"	43 3/4"	49 3/4"	55 3/4"
ROUGH OPENING	24"	30"	36"	42"	48"	54"
FRAME SIZE	23 1/2"	29 1/2"	35 1/2"	41 1/2"	47 1/2"	53 1/2"
DAYLIGHT OPENING	19 29/32"	25 29/32"	31 29/32"	37 29/32"	43 29/32"	49 29/32"
25 3/4" 24" 23 1/2" 19 29/32"	 7PCA2424	 7PCA3024	 7PCA3624	 7PCA4224	 7PCA4824	 7PCA5424
31 3/4" 30" 29 1/2" 25 29/32"	 7PCA2430	 7PCA3030	 7PCA3630	 7PCA4230	 7PCA4830	 7PCA5430
37 3/4" 36" 35 1/2" 31 29/32"	 7PCA2436	 7PCA3036	 7PCA3636	 7PCA4236	 7PCA4836	 7PCA5436
43 3/4" 42" 41 1/2" 37 29/32"	 7PCA2442	 7PCA3042	 7PCA3642	 7PCA4242	 7PCA4842	 7PCA5442
49 3/4" 48" 47 1/2" 43 29/32"	 7PCA2448	 7PCA3048	 7PCA3648	 7PCA4248	 7PCA4848	 7PCA5448
55 3/4" 54" 53 1/2" 49 29/32"	 7PCA2454	 7PCA3054	 7PCA3654	 7PCA4254	 7PCA4854	 7PCA5454
61 3/4" 60" 59 1/2" 55 29/32"	 7PCA2460	 7PCA3060	 7PCA3660	 7PCA4260	 7PCA4860	 7PCA5460

ELEVATION SYMBOL LEGEND:
 ### NUMBER INDICATES DESIGN PRESSURE (DP) RATING WITH STANDARD GLAZING.

SCALE: 1/4" = 1'

CLIPPED CORNER





UNIT SIZE	25 3/4"	31 3/4"	37 3/4"	43 3/4"	49 3/4"	55 3/4"	
ROUGH OPENING	24"	30"	36"	42"	48"	54"	
FRAME SIZE	23 1/2"	29 1/2"	35 1/2"	41 1/2"	47 1/2"	53 1/2"	
DAYLIGHT OPENING	19 29/32"	25 29/32"	31 29/32"	37 29/32"	43 29/32"	49 29/32"	
67 3/4" 66" 65 1/2" 67 29/32"							
	7PCA2466	7PCA3066	7PCA3666	7PCA4266	7PCA4866	7PCA5466	
	73 3/4" 72" 71 1/2" 67 29/32"						
		7PCA2472	7PCA3072	7PCA3672	7PCA4272	7PCA4872	7PCA5472

ELEVATION SYMBOL LEGEND:
##* NUMBER INDICATES DESIGN PRESSURE (DP) RATING WITH STANDARD GLAZING.

SCALE: 1/4" = 1'

CLIPPED CORNER

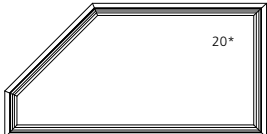
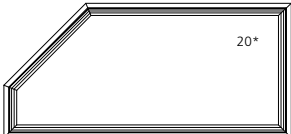
UNIT SIZE
ROUGH OPENING
FRAME SIZE
DAYLIGHT OPENING

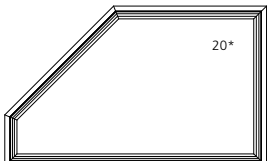
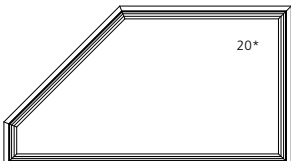
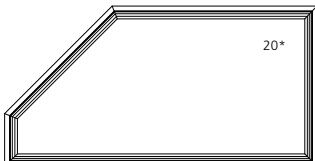
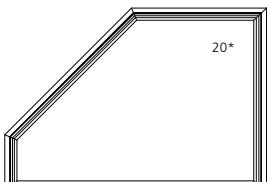
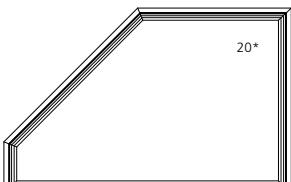
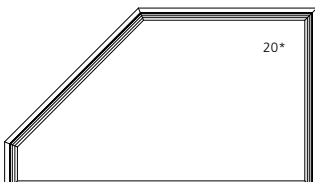
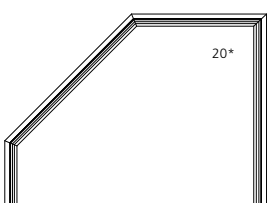
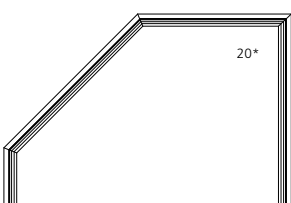
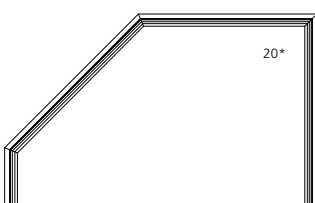
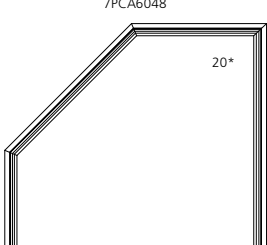
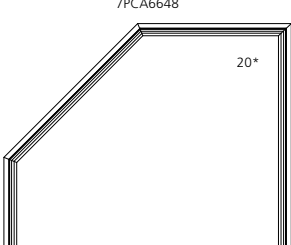
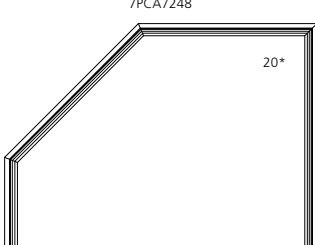
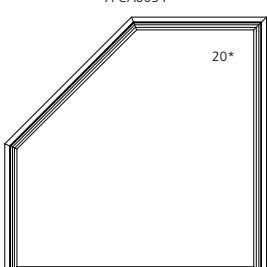
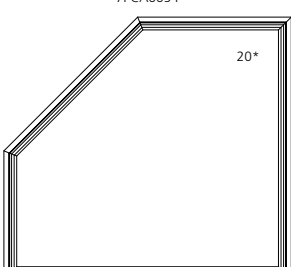
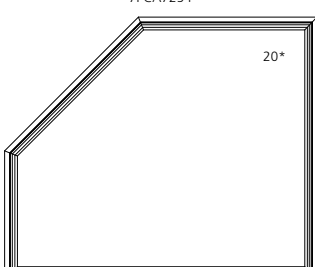
	61 3/4" 60" 59 1/2" 55 29/32"	67 3/4" 66" 65 1/2" 61 29/32"	73 3/4" 72" 71 1/2" 67 29/32"
25 3/4" 24" 23 1/2" 19 29/32"	 20*	 20*	 20*
	7PCA6024	7PCA6624	7PCA7224
31 3/4" 30" 29 1/2" 25 29/32"	 20*	 20*	 20*
	7PCA6030	7PCA6630	7PCA7230
37 3/4" 36" 35 1/2" 31 29/32"	 20*	 20*	 20*
	7PCA6036	7PCA6636	7PCA7236
43 3/4" 42" 41 1/2" 37 29/32"	 20*	 20*	 20*
	7PCA6042	7PCA6642	7PCA7242
49 3/4" 48" 47 1/2" 43 29/32"	 20*	 20*	 20*
	7PCA6048	7PCA6648	7PCA7248
55 3/4" 54" 53 1/2" 49 29/32"	 20*	 20*	 20*
	7PCA6054	7PCA6654	7PCA7254
61 3/4" 60" 59 1/2" 55 29/32"	 20*	 20*	 20*
	7PCA6060	7PCA6660	7PCA7260

ELEVATION SYMBOL LEGEND:
##* NUMBER INDICATES DESIGN PRESSURE (DP) RATING WITH STANDARD GLAZING.

SCALE: 1/4" = 1'

CLIPPED CORNER

UNIT SIZE
ROUGH OPENING
FRAME SIZE
DAYLIGHT OPENING

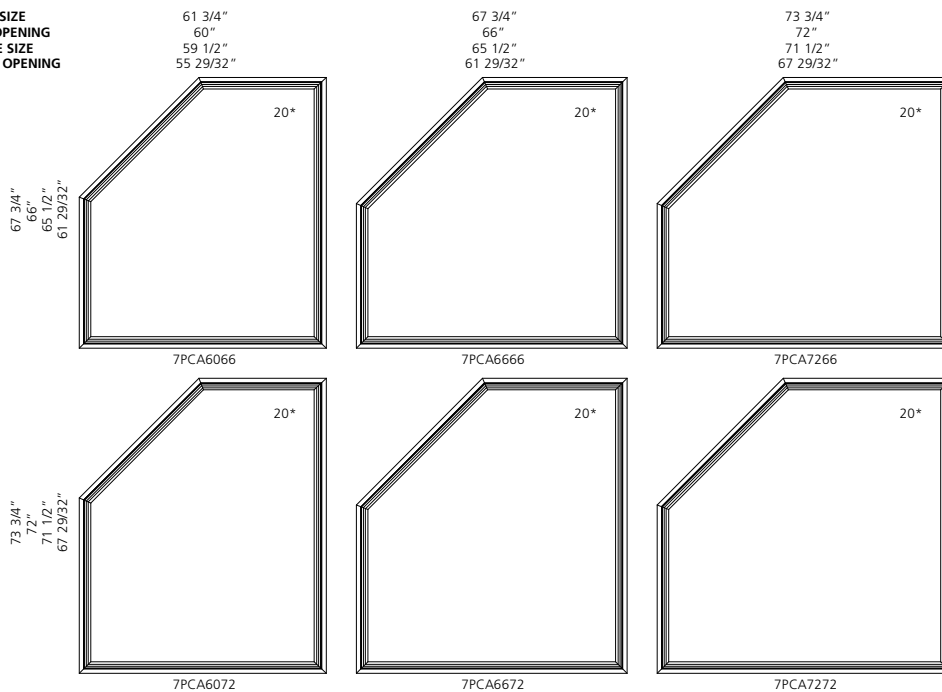







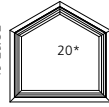
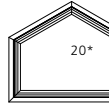
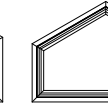
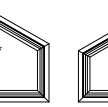
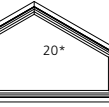
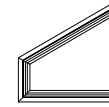
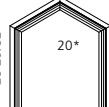
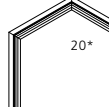
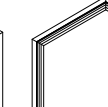
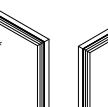
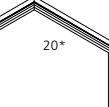
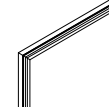
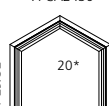
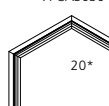
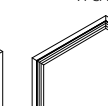
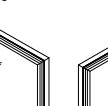
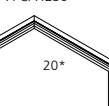
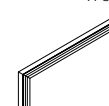
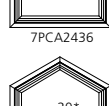
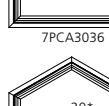
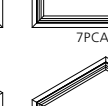
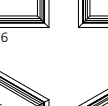
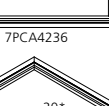

ELEVATION SYMBOL LEGEND:

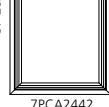
##* NUMBER INDICATES DESIGN PRESSURE (DP) RATING WITH STANDARD GLAZING.

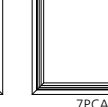
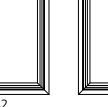
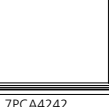
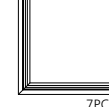
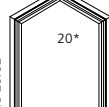
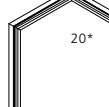
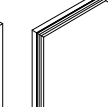
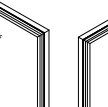
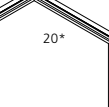
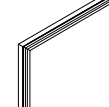
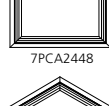
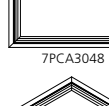
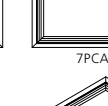
SCALE: 1/4" = 1'

PENTAGON

UNIT SIZE	25 3/4"	31 3/4"	37 3/4"	43 3/4"	49 3/4"	55 3/4"
ROUGH OPENING	24"	30"	36"	42"	48"	54"
FRAME SIZE	23 1/2"	29 1/2"	35 1/2"	41 1/2"	47 1/2"	53 1/2"
DAYLIGHT OPENING	19 29/32"	25 29/32"	31 29/32"	37 29/32"	43 29/32"	49 29/32"
25 3/4" 24" 23 1/2" 19 29/32"	 7PCA2424	 7PCA3024	 7PCA3624	 7PCA4224	 7PCA4824	 7PCA5424
31 3/4" 30" 29 1/2" 25 29/32"	 7PCA2430	 7PCA3030	 7PCA3630	 7PCA4230	 7PCA4830	 7PCA5430
37 3/4" 36" 35 1/2" 31 29/32"	 7PCA2436	 7PCA3036	 7PCA3636	 7PCA4236	 7PCA4836	 7PCA5436
43 3/4" 42" 41 1/2" 37 29/32"	 7PCA2442	 7PCA3042	 7PCA3642	 7PCA4242	 7PCA4842	 7PCA5442
49 3/4" 48" 47 1/2" 43 29/32"	 7PCA2448	 7PCA3048	 7PCA3648	 7PCA4248	 7PCA4848	 7PCA5448
55 3/4" 54" 53 1/2" 49 29/32"	 7PCA2454	 7PCA3054	 7PCA3654	 7PCA4254	 7PCA4854	 7PCA5454
61 3/4" 60" 59 1/2" 55 29/32"	 7PCA2460	 7PCA3060	 7PCA3660	 7PCA4260	 7PCA4860	 7PCA5460

ELEVATION SYMBOL LEGEND:
NUMBER INDICATES DESIGN PRESSURE (DP) RATING WITH STANDARD GLAZING.

SCALE: 1/4" = 1'

PENTAGON

	25 3/4"	31 3/4"	37 3/4"	43 3/4"	49 3/4"	55 3/4"
UNIT SIZE	25 3/4"	31 3/4"	37 3/4"	43 3/4"	49 3/4"	55 3/4"
ROUGH OPENING	24"	30"	36"	42"	48"	54"
FRAME SIZE	23 1/2"	29 1/2"	35 1/2"	41 1/2"	47 1/2"	53 1/2"
DAYLIGHT OPENING	19 29/32"	25 29/32"	31 29/32"	37 29/32"	43 29/32"	49 29/32"
	67 3/4" 66" 65 1/2" 61 29/32"					
	7PCA2466	7PCA3066	7PCA3666	7PCA4266	7PCA4866	7PCA5466
	73 3/4" 72" 71 1/2" 67 29/32"					
	7PCA2472	7PCA3072	7PCA3672	7PCA4272	7PCA4872	7PCA5472

ELEVATION SYMBOL LEGEND:
##* NUMBER INDICATES DESIGN PRESSURE (DP) RATING WITH STANDARD GLAZING.

SCALE: 1/4" = 1'

PENTAGON

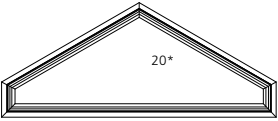
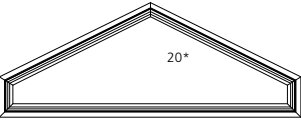
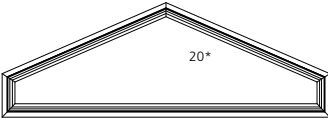
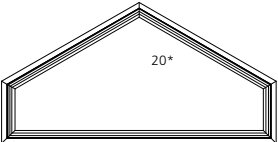
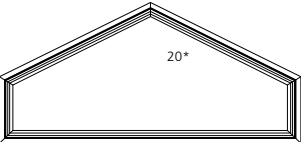
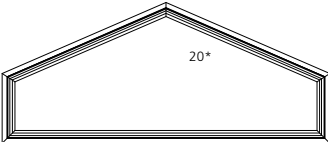
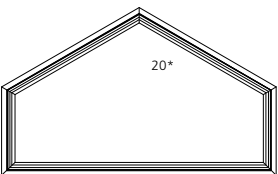
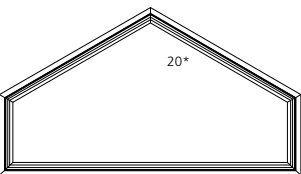
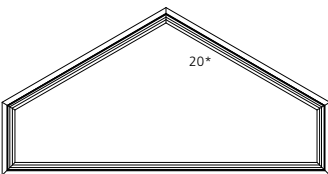
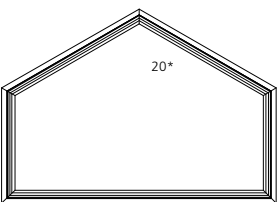
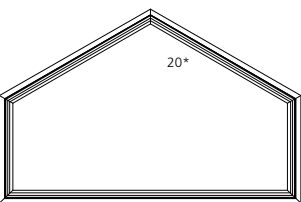
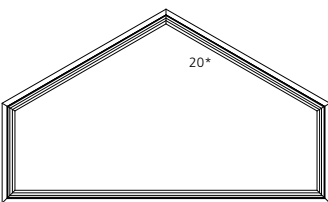
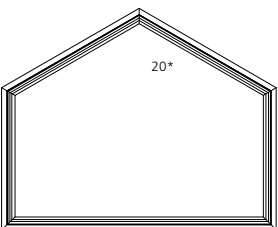
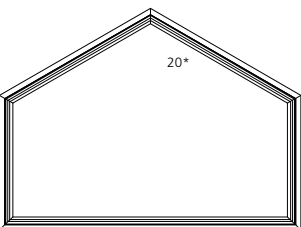
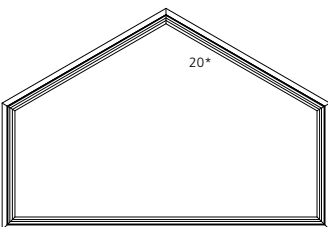
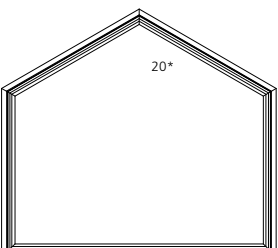
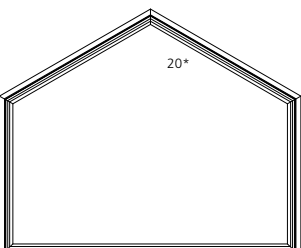
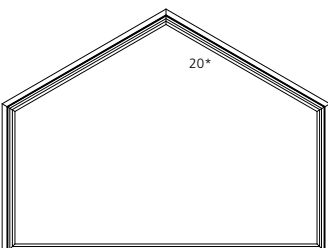
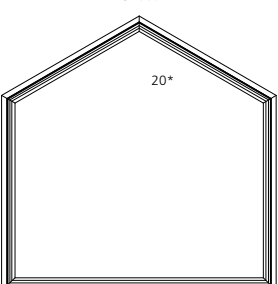
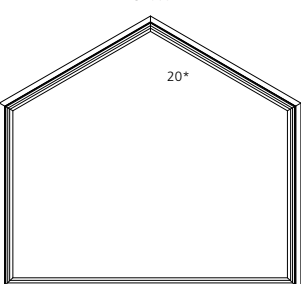
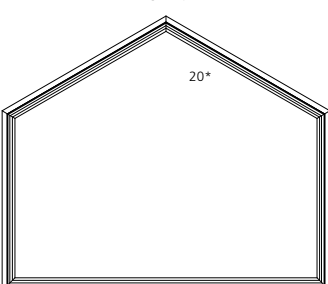
UNIT SIZE	61 3/4"	67 3/4"	73 3/4"
ROUGH OPENING	60"	66"	72"
FRAME SIZE	59 1/2"	65 1/2"	71 1/2"
DAYLIGHT OPENING	55 29/32"	61 29/32"	67 29/32"
25 3/4" 24" 23 1/2" 19 29/32"	 7PCA6024	 7PCA6624	 7PCA7224
31 3/4" 30" 29 1/2" 25 29/32"	 7PCA6030	 7PCA6630	 7PCA7230
37 3/4" 36" 35 1/2" 31 29/32"	 7PCA6036	 7PCA6636	 7PCA7236
43 3/4" 42" 41 1/2" 37 29/32"	 7PCA6042	 7PCA6642	 7PCA7242
49 3/4" 48" 47 1/2" 43 29/32"	 7PCA6048	 7PCA6648	 7PCA7248
55 3/4" 54" 53 1/2" 49 29/32"	 7PCA6054	 7PCA6654	 7PCA7254
61 3/4" 60" 59 1/2" 55 29/32"	 7PCA6060	 7PCA6660	 7PCA7260

ELEVATION SYMBOL LEGEND:
##* NUMBER INDICATES DESIGN PRESSURE (DP) RATING WITH STANDARD GLAZING.

SCALE: 1/4" = 1'

PENTAGON

UNIT SIZE
ROUGH OPENING
FRAME SIZE
DAYLIGHT OPENING

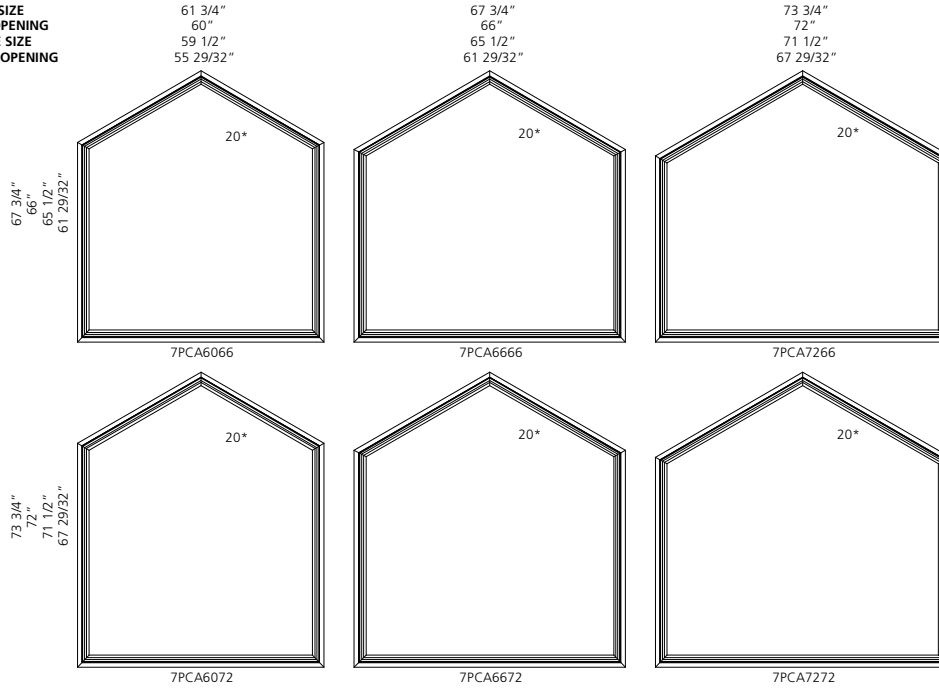

ELEVATION SYMBOL LEGEND:
##* NUMBER INDICATES DESIGN PRESSURE (DP) RATING WITH STANDARD GLAZING.

SCALE: 1/4" = 1'

GRILLE PATTERNS

PICTURE UNITS

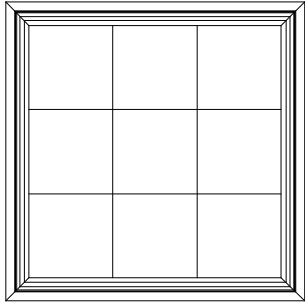

STANDARD

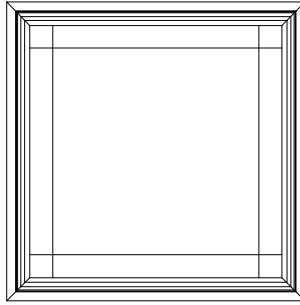

PRAIRIE

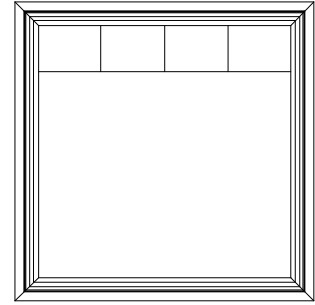

COLONIAL TOP 1/2

GRILLE PATTERNS
QUARTER ROUND

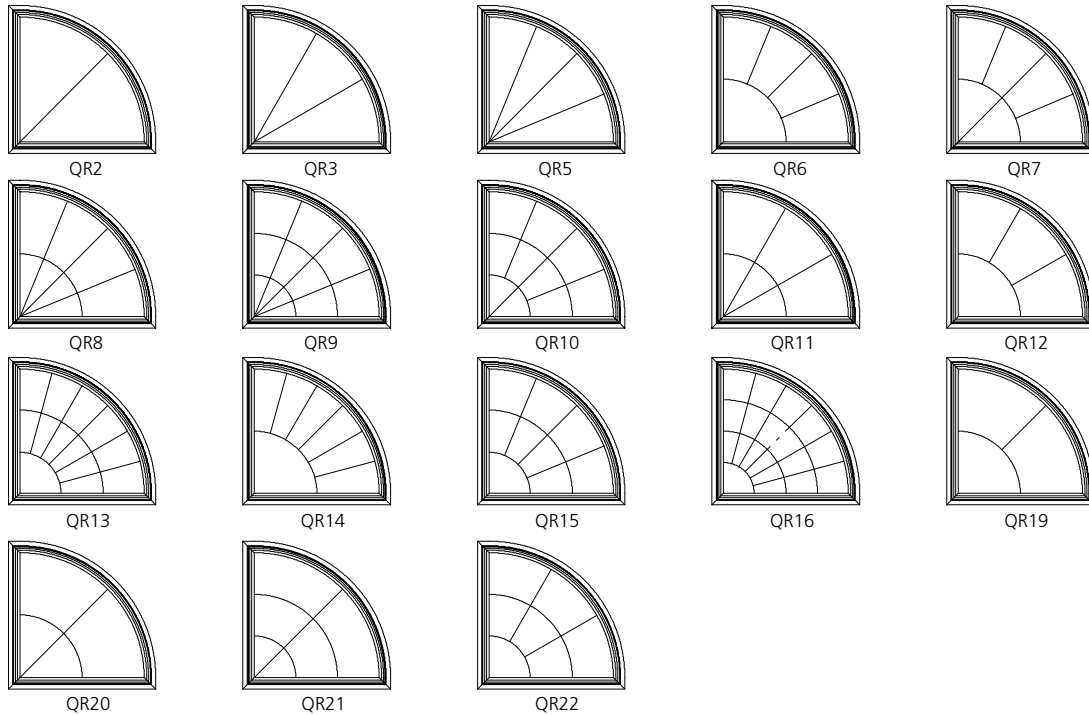

HALF ROUND

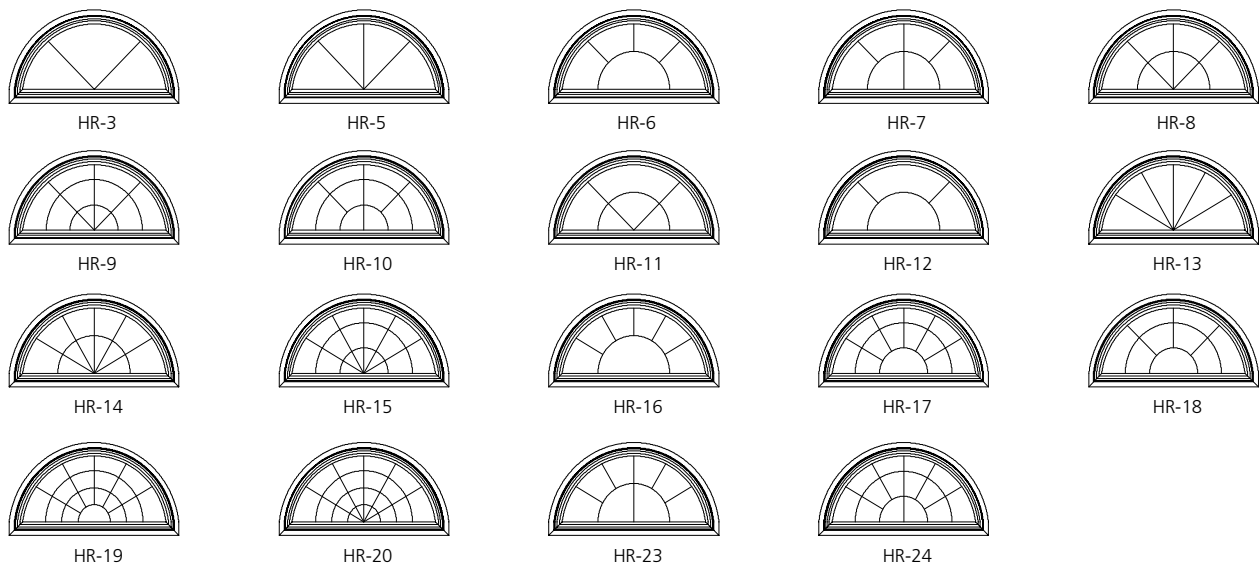

FULL ROUND

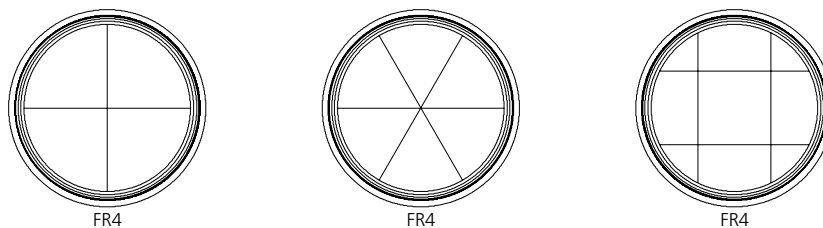

GRILLE PATTERNS

EXTENDED QUARTER ROUND

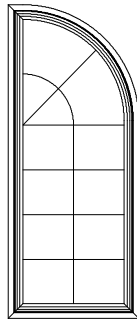

QT1

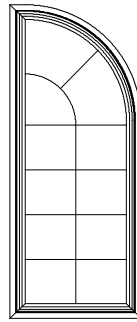

QT2

EXTENDED HALF ROUND

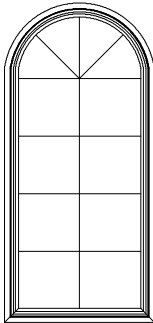

RT1

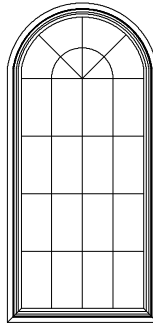

RT2

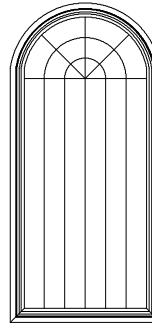

RT3

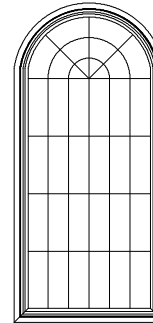

RT4

EXTENDED CIRCLE SEGMENT

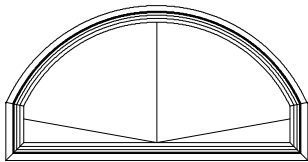

LP1

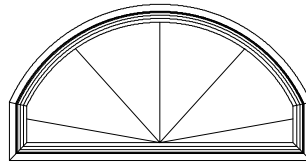

LP2

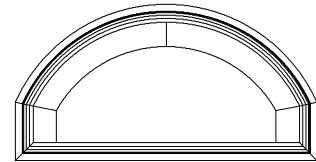

LP3

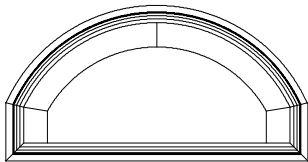

LP4

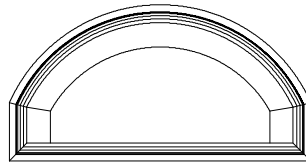

LP5

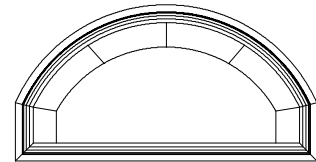

LP7

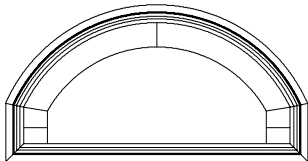

LP8

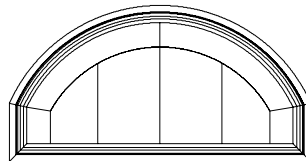

LP14

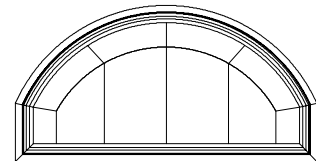

LP16

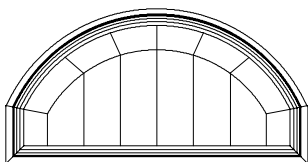

LP18

PICTURE UNIT

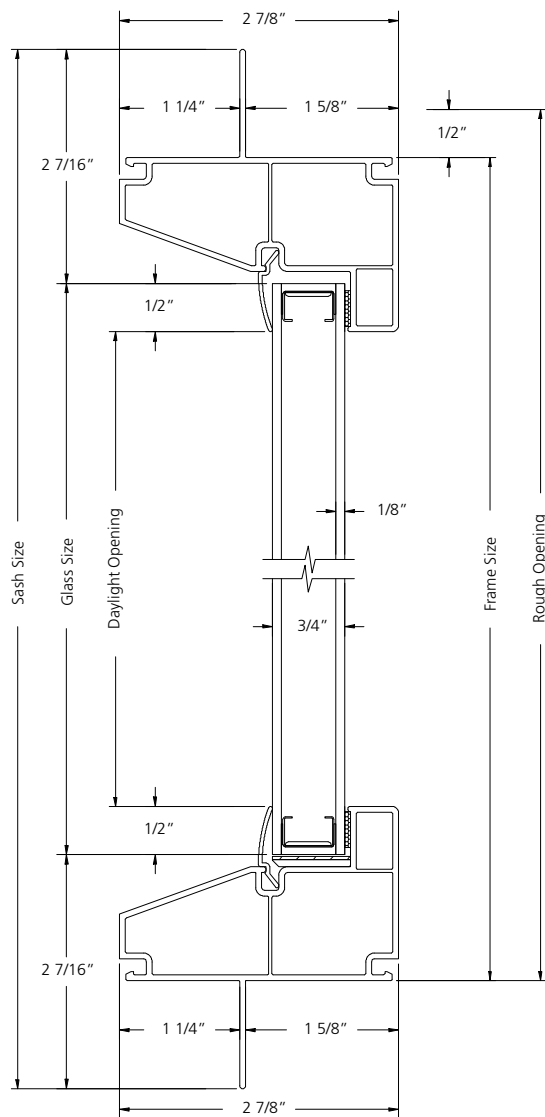

VERTICAL SECTION

SCALE: 6" = 1'

PICTURE UNIT

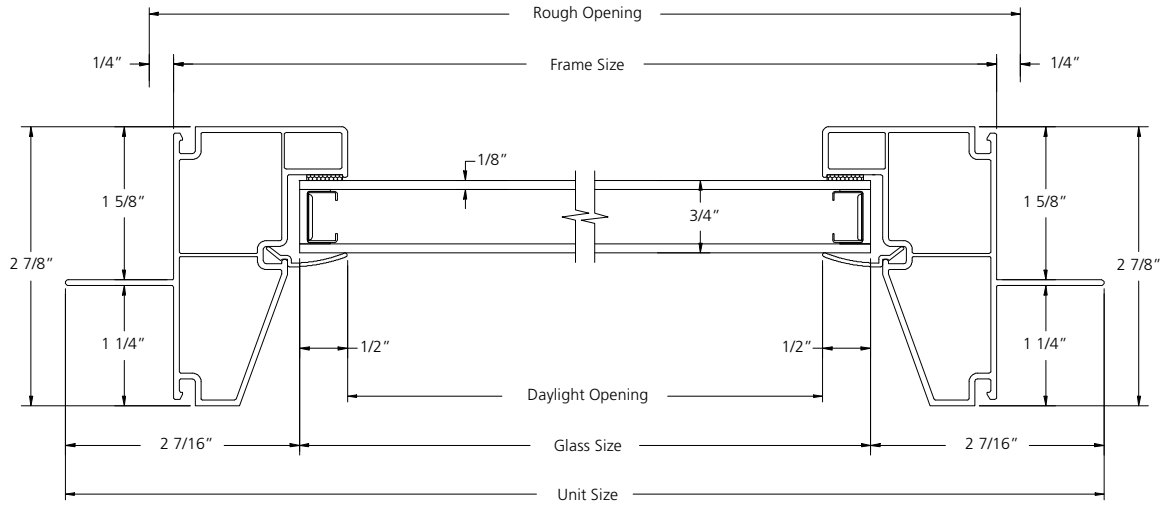

HORIZONTAL SECTION

SCALE: 6" = 1'