

#### FEATURED MODEL

441078 Laundry Single Bowl (1-Hole), 12" bowl depth

#### FEATURES

- Required outside cabinet: 24"
- 18 gauge, 304 series stainless steel
- Premium 18/10 chrome/nickel content
- Brushed Satin finish
- Sound deadening pads
- Rail clip system provides easy install with maximum countertop secure fit
- Coordinates with BLANCO TORINO faucet

#### CODE/STANDARDS COMPLIANCE

ASME 112.19.3-00  
IAPMO/UPC listed



#### NOMINAL DIMENSIONS

Model 441078 shown

OVERALL	CUT OUT SIZE	BOWL DEPTH	DRAIN
25" x 22"	24" x 21-1/8"	12"	3-1/2"

DXF cutout templates available on our website.

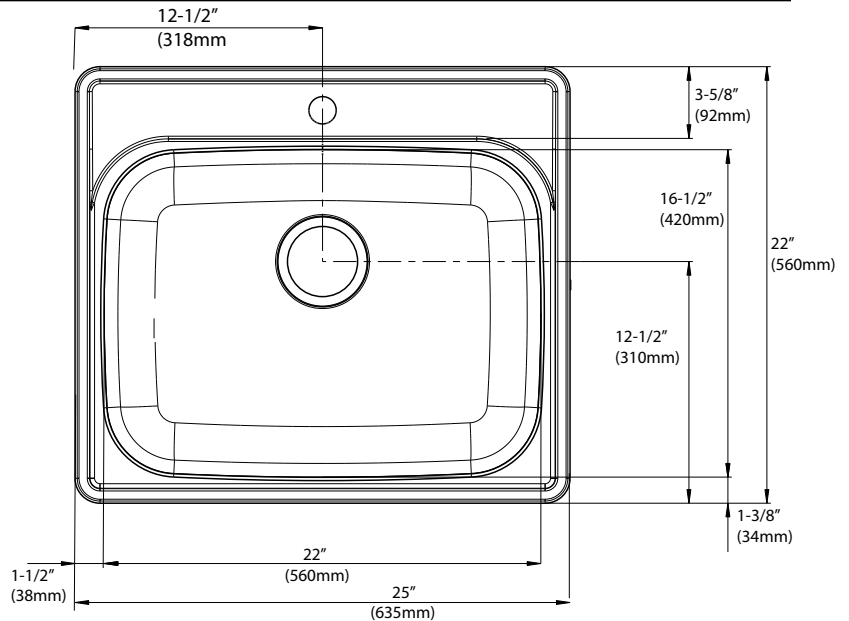

#### WARRANTY

Blanco America's Stainless Steel sinks feature a LIMITED LIFETIME WARRANTY to be free of all manufacturing defects under normal use. See our complete warranty for details.

While Blanco America endeavors to provide accurate information, all dimensions are nominal, cannot be guaranteed, and are subject to change or cancellation. Blanco America assumes no responsibility for use of superseded or voided specifications.

#### JOB INFORMATION

Job Name: \_\_\_\_\_

Contact: \_\_\_\_\_

Date Specified: \_\_\_\_\_

Specifier: \_\_\_\_\_

Contractor: \_\_\_\_\_

#### BLANCO AMERICA

800.451.5782

www.blancoamerica.com

© 2013 BLANCO AMERICA

6/13

SPEC-003