

SPECIFICATION SHEET

PRODUCT FAMILY: Sinks FINISH: Stainless Steel SERIES: PROFESSIONAL SERIES MODEL: PSX110168

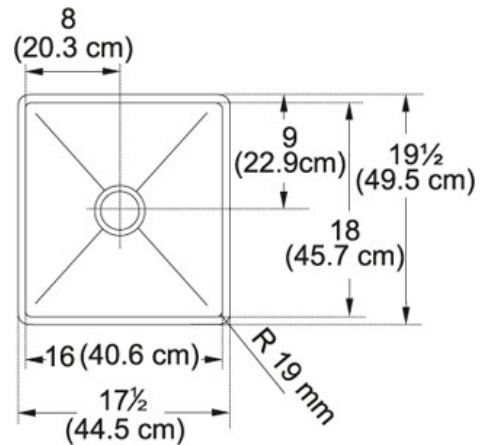

Product Information

FUN#	122.0170.024
US Part Number	PSX110168
Minimum Cabinet Size	21"
Drain Opening	3 1/2"
Outer Dimensions	17 1/2"x19 11/16"
Bowl Size	16 1/8"x18 1/8"x7 1/8"
Number of Bowls	1
Cut-Out Template	Yes
Type of Material	16-GA-STAINLESS-STEEL

Accessories



112.0039.150

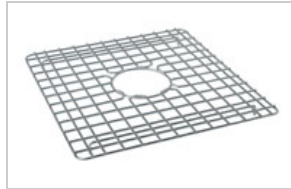

112.0066.259



112.0066.287



112.0079.835

Suggested Products



115.0190.774



119.0066.616



119.0068.283



120.0296.741



133.0171.120



134.0297.202