

cod. FPD124N

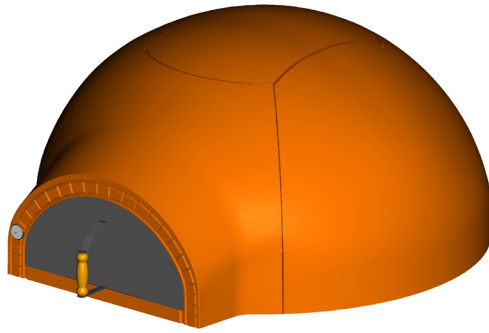

CARATTERISTICHE TECNICHE / TECHNICAL DETAILS

Peso / Weight	420 Kg / 925,9 Lbs
Area piano forno / Oven floor area	1,25 m ² / 13,4 ft ²
Minuti per scaldare / Heating time	60
N° pizze alla volta / Pizza capacity	7
Infornata di pane / Bread capacity	14 Kg / 30,8 Lbs
Consumo medio / Average fuel consumption	8 Kg/h / 17,6 Lbs/h
Temperatura massima / Max oven temperature	400 °C / 752 °F
Combustibile consigliato / Recommended fuel	Ciocchi, potature / Logs, trimmings

CANNA FUMARIA (inst. interna) / CHIMNEY (for indoor installation)

Altezza canna > 5 mt / Chimney height >16,4 ft	Altezza canna > 4 mt / Chimney height >13,1 ft	Altezza canna > 3 mt / Chimney height >9,8 ft
Diametro 20 cm oppure 20x20 cm / Diameter 7,8 In or 7,8x7,8 In	Diametro 25 cm oppure 25x25 cm o 20x30 cm / Diameter 9,8 In or 9,8x9,8 In or 7,8x11,8 In	Diametro 30 cm oppure 30x30 cm / Diameter 11,8 In or 11,8x11,8 In

MISURE / DIMENSIONS

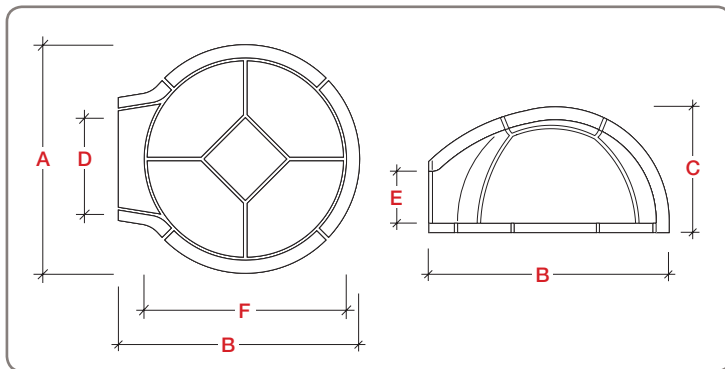

MISURE / DIMENSIONS

A	Larghezza totale / Total width	135 cm / 53,1 In
B	Lunghezza totale / Total length	141 cm / 55,5 In
C	Altezza totale / Total height	68 cm / 26,7 In
D	Larghezza bocca / Oven mouth width	60 cm / 23,6 In
E	Altezza bocca / Oven mouth height	28 cm / 11 In
F	Diametro interno / Inside diameter	120 cm / 47,2 In

MONTAGGIO e componenti / ASSEMBLY and parts list

Cod.	N°	Desc.
a	XFBP124	1 Bocca P124
b	XFDP124	1 Davanzalino P124
c	XFPE124	4 Piano a settori P124
d	XFP4040	1 Piano a quadrato 40x40 P124
e/g	XFCL125	3 Cupola laterale P124
f	XFCS125	1 Cupola superiore P124
h	YT50320	1 Termometro d.50 l.320 mm P124
i	YSPOPER	1 Sportello P124

N.B. Seguire l'ordine alfabetico per il montaggio del forno.