



Features

- Integral flange.
- Left drain.
- Slotted overflow for deep soaking.
- Integral lumbar support and armrests for comfort.
- Integral apron with removable access panel.

Material

- Acrylic

Hydrotherapy

- Single-speed whirlpool offers eight fully adjustable hydro-massage jets for water flow and direction.
- Pump with air switch for whirlpool.

Installation

- Alcove

Required Accessories

K-7271 Brass Slotted Overflow Bath Drain

or

K-7272 PVC Slotted Overflow Bath Drain

Recommended Accessories

- K-24916 Wireless Music Kit
- K-1491 Bath/Whirlpool Pillow
- K-1601 Bath/Whirlpool Footstop
- K-702200-G54 Frameless Sliding Bath Door
- K-702200-G73 Frameless Sliding Bath Door
- K-702200-L Frameless Sliding Bath Door
- K-702205-L Frameless Sliding Bath Door



ADA

Codes/Standards

ASME A112.19.7/CSA B45.10

CSA B45.5/IAPMO Z124

UL 1795

Greenguard UL 2818 - Gold

ADA











ICC/ANSI A117.1

KOHLER® One-Year Limited Warranty

See website for detailed warranty information.

Available Color/Finishes

Color tiles intended for reference only.

Color	Code	Description
	0	White
	96	Biscuit
	47	Almond
	NY	Dune
	95	Ice™ Grey
	G9	Sandbar
	33	Mexican Sand™
	K4	Cashmere
	58	Thunder™ Grey
	7	Black Black™

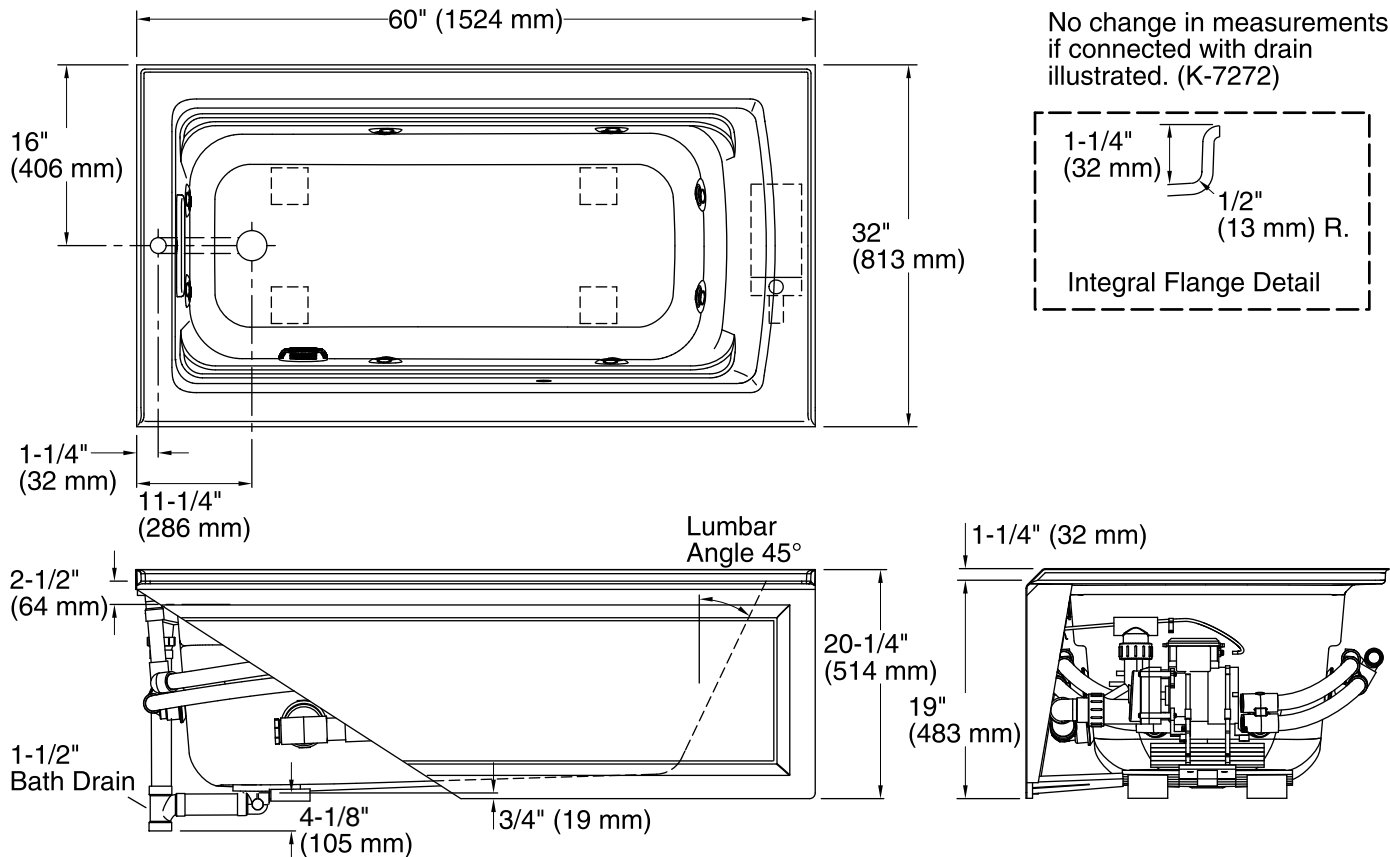

Required Electrical Service

One dedicated circuit required, protected with Class A Ground-Fault Circuit-Interrupter (GFCI) or Residual Current Device (RCD).

Pump: 120 V, 15 A, 60 Hz

Technical Information

All product dimensions are nominal.

Installation: 3-Wall Alcove

Drain location: Left

Basin area, bottom: 45-1/8" x 19-11/16" (1146 mm x 500 mm)

Basin area, top: 52-3/4" x 25-5/16" (1340 mm x 643 mm)

Weight: 135 lbs (61.2 kg)

Minimum floor load: 49 lbs/ft² (239.2 kg/m²)

Water depth: 15" (381 mm)

Water capacity: 58 gal (219.6 L)

Electrical component rating: Pump: 120 V, 7 A, 60 Hz

Pump speed: Single

Minimum flat for door: 2-3/16" (56 mm)

Notes

Measure your actual product for rough-in details.

Install this product according to the installation instructions.

The hot water supply should be 70% of the capacity of the bath or greater. Installations will vary.

Provide one grounded electrical outlet within 24" (610 mm) of each component.

ADA compliant when installed to the specific requirements of these regulations.