



Features

- Integral flange.
- Left drain.
- Integral lumbar support.
- Integral apron with removable access panel.
- 60" (1524 mm) x 32" (813 mm) x 20" (508 mm)

Material

- Acrylic

Hydrotherapy

- 120 BubbleMassage™ airjets.
- Zones of Control feature allows you to target massage to back, midsection, or feet.
- Automatic purge cycles remove residual water from air channels after use.
- Built-in 300 W heater.
- Lighted keypad control.

Installation

- Alcove

Recommended Accessories

- K-11677 Bath Drain
- K-1446 Remote Installation Kit
- K-9497 2-1/2" Keypad Trim
- K-24916 Wireless Music Kit
- K-1491 Bath/Whirlpool Pillow
- K-1601 Bath/Whirlpool Footstop
- K-7259 Clearflo Bath Drain
- K-37380 30" Rough-in Cable Bath Drain
- K-37383 30" Rough-in Cable Bath Drain
- K-702200-G54 Frameless Sliding Bath Door
- K-702200-G73 Frameless Sliding Bath Door
- K-702200-L Frameless Sliding Bath Door
- K-702205-L Frameless Sliding Bath Door
- K-706000-D3 Frameless Sliding Bath Door
- K-706000-L Frameless Sliding Bath Door
- K-706003-L Frameless Sliding Bath Door
- K-706004-D3 Frameless Sliding Bath Door
- K-706004-L Frameless Sliding Bath Door
- K-706007-L Frameless Sliding Bath Door



Codes/Standards





ASME A112.19.7/CSA B45.10
 CSA B45.5/IAPMO Z124
 ASTM E162
 ASTM E662
 UL 1795
 Greenguard UL 2818 - Gold

KOHLER® One-Year Limited Warranty

See website for detailed warranty information.

Available Color/Finishes

Color tiles intended for reference only.

Color	Code	Description
	0	White
	96	Biscuit
	47	Almond
	NY	Dune
	G9	Sandbar

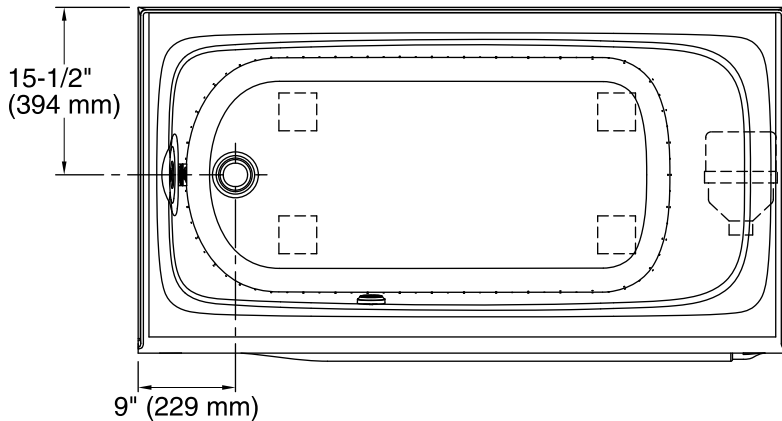

No change in measurements if connected with drain illustrated. (K-11677)

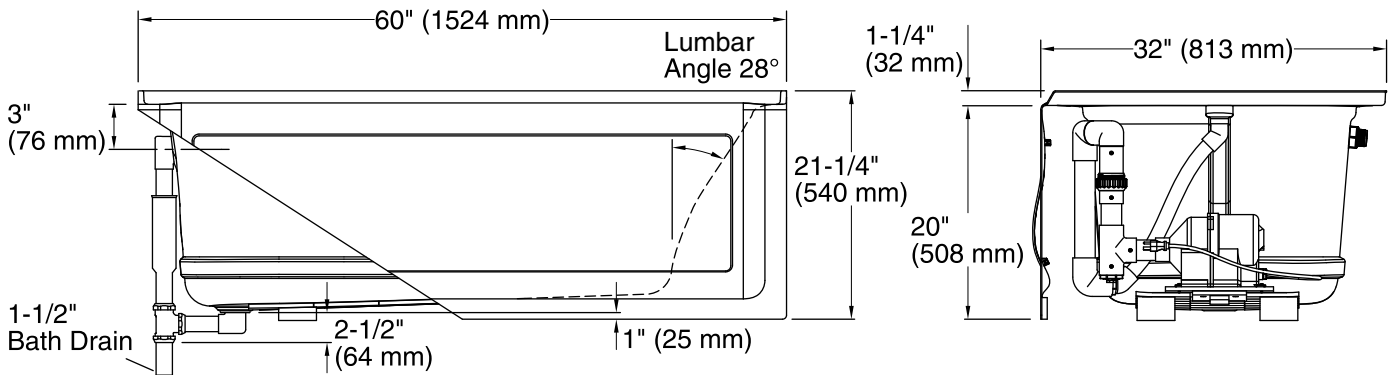
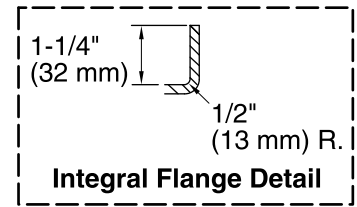

Required Electrical Service

One dedicated circuit required, protected with Class A Ground-Fault Circuit-Interrupter (GFCI) or Residual Current Device (RCD).

Blower: 120 V, 15 A, 60 Hz

Technical Information

All product dimensions are nominal.

- Installation: 3-Wall Alcove
- Drain location: Left
- Basin area, bottom: 45" x 22" (1143 mm x 559 mm)
- Basin area, top: 54" x 25" (1372 mm x 635 mm)
- Weight: 100 lbs (45.4 kg)
- Minimum floor load: 49 lbs/ft² (239.2 kg/m²)
- Water depth: 15" (381 mm)
- Water capacity: 60 gal (227.1 L)
- Electrical component rating: Blower: 120 V, 10 A, 60 Hz, 300 W
- Minimum flat for door: 2" (51 mm)

Notes

- Measure your actual product for rough-in details. Install this product according to the installation instructions.
- The hot water supply should be 70% of the capacity of the bath or greater. Installations will vary.
- Provide one grounded electrical outlet within 24" (610 mm) of each component.
- Remote blower installation kit is available for relocating the blower. Provide access for servicing the blower.
- Do not relocate or alter the PVC tee or coiled flexible tubing connected to the blower. Follow the blower relocation instructions exactly.