

Features

- KOHLER finishes resist corrosion and tarnish.
- Distinctive 24- inch double bars.
- Coordinates with other products in the Devonshire collection.
- 26-3/8" (670 mm) x 5-7/8" (149 mm) x 4" (102 mm)

Material

- Premium metal construction for durability.

Components

Additional included component/s: Installation hardware, and template.

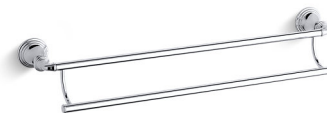

Codes/Standards







None Applicable

KOHLER® Faucet Lifetime Limited Warranty

See website for detailed warranty information.

Available Color/Finishes

Color tiles intended for reference only.

Color	Code	Description
	CP	Polished Chrome
	SN	Vibrant® Polished Nickel
	PB	Vibrant® Polished Brass
	BN	Vibrant® Brushed Nickel
	BV	Vibrant® Brushed Bronze
	2BZ	Oil-Rubbed Bronze

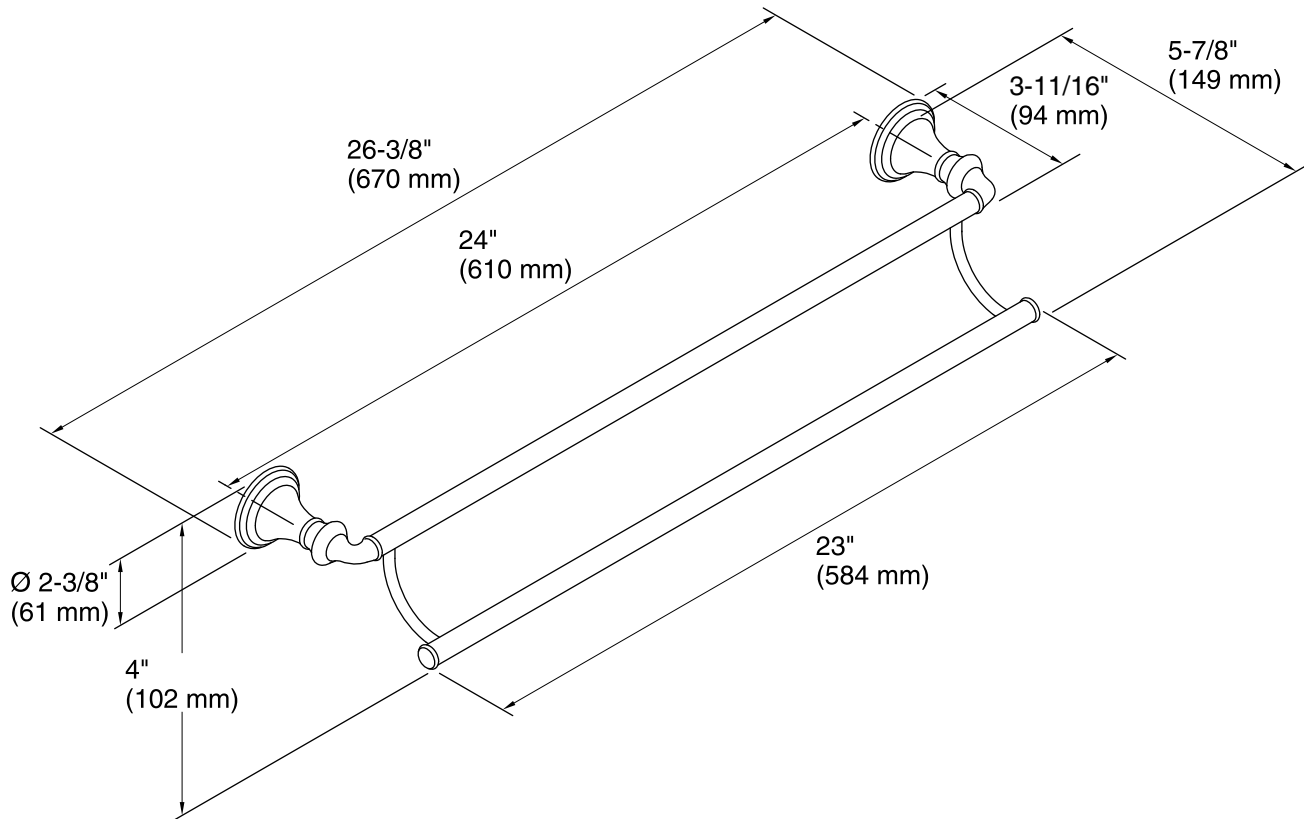

Technical Information

All product dimensions are nominal.

Notes

Install this product according to the installation guide.

CAUTION: Risk of personal injury. Do not install these products in any area where they are likely to be used inadvertently as a grab bar or support bar. These products are not designed or intended for use as a grab bar or support bar.