



### Features

- Comfort Depth® design offers a 19" (483 mm) step-over height.
- End drain.
- Slotted overflow for deep soaking.
- Integral lumbar support and armrests for comfort.
- Bask® heated surface creates spa-like relaxation with soothing warmth on your back, shoulders, and neck.
- Textured bottom surface.
- Coordinates with other products in the Archer® collection.
- 72" (1829 mm) x 36" (914 mm) x 19" (483 mm)

### Material

- Acrylic

### Hydrotherapy

- Single-speed whirlpool offers eight fully adjustable hydro-massage jets for water flow and direction.

### Installation

- Drop-in

### Required Accessories

K-7271 Brass Slotted Overflow Bath Drain

or

K-7272 PVC Slotted Overflow Bath Drain

### Recommended Accessories

K-9529 Removable Bath Seat

K-24916 Wireless Music Kit



ADA

### Codes/Standards

ASME A112.19.7/CSA B45.10

CSA B45.5/IAPMO Z124

ASTM E162

ASTM E662

UL 1795

Greenguard UL 2818 - Gold

ADA

ICC/ANSI A117.1









CARB P2

### KOHLER® One-Year Limited Warranty

See website for detailed warranty information.

### Available Color/Finishes

*Color tiles intended for reference only.*

Color	Code	Description
	0	White
	96	Biscuit
	47	Almond
	NY	Dune
	95	Ice™ Grey
	G9	Sandbar
	33	Mexican Sand™
	K4	Cashmere

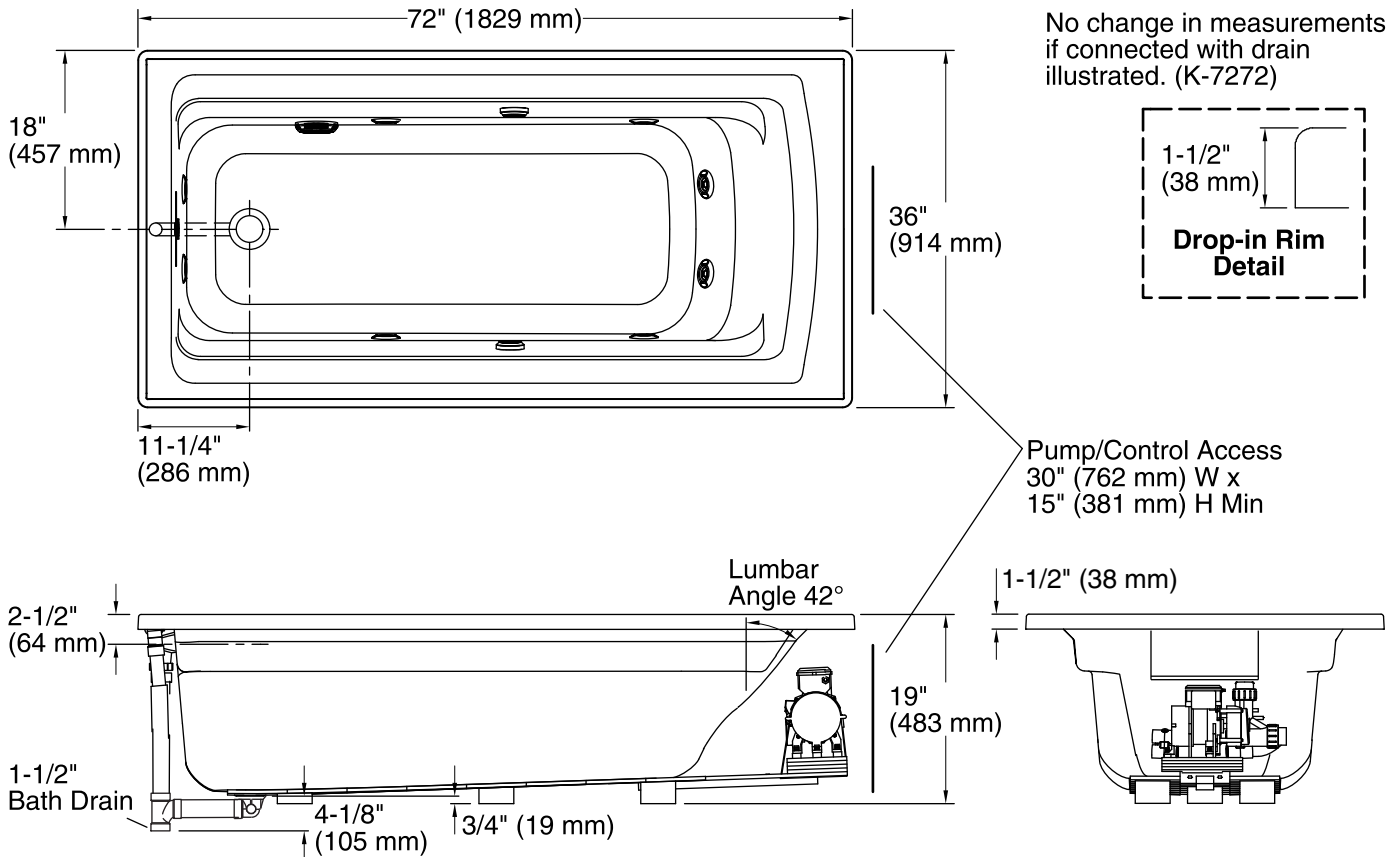

No change in measurements if connected with drain illustrated. (K-7272)

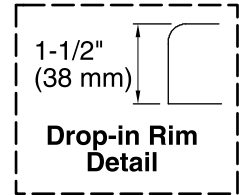

Pump/Control Access  
30" (762 mm) W x  
15" (381 mm) H Min

### Required Electrical Service

One dedicated circuit required, protected with Class A Ground-Fault Circuit-Interrupter (GFCI) or Residual Current Device (RCD).

Pump, Heated 120 V, 15 A  
Surface:

### Technical Information

All product dimensions are nominal.

Installation:	Drop-in
Drain location:	End
Basin area, bottom:	51-3/8" x 21" (1305 mm x 533 mm)
Basin area, top:	64-1/2" x 30-1/2" (1638 mm x 775 mm)
Weight:	116 lbs (52.6 kg)
Minimum floor load:	41 lbs/ft <sup>2</sup> (200.2 kg/m <sup>2</sup> )
Water depth:	15" (381 mm)
Water capacity:	72 gal (272.5 L)
Cutout:	Drop-in, 70-1/2" x 34-1/2" (1791 mm x 876 mm)
Electrical component rating:	Pump: 120 V, 7 A, 60 Hz Heated Surface: 120 V, 0.5 A, 60 Hz
Pump speed:	Single

### Notes

Measure your actual product for rough-in details.

Install this product according to the installation instructions.

The hot water supply should be 70% of the capacity of the bath or greater. Installations will vary.

Provide one grounded electrical outlet within 24" (610 mm) of each component.

This bath is designed for drop-in installation only. It is not suited for use in a three wall alcove with an overhead shower.

ADA compliant when installed to the specific requirements of these regulations.