



Features

- Integral flange.
- Right drain.
- Bask® heated surface creates spa-like relaxation with soothing warmth on your back, shoulders, and neck.
- Integral lumbar support and armrests for comfort.
- Integral apron with removable access panel.
- Textured bottom surface.
- 60" (1524 mm) x 36" (914 mm) x 21-1/4" (540 mm)

Material

- Acrylic

Hydrotherapy

- Single-speed whirlpool offers 5 fully adjustable hydro-massage jets for water flow and direction.
- Pump with air switch for whirlpool.

Installation

- Alcove

Recommended Accessories

- K-7161-AF Bath Drain
- K-9695 5-Jet Trim Kit
- K-24916 Wireless Music Kit
- K-37380 30" Rough-in Cable Bath Drain
- K-37383 30" Rough-in Cable Bath Drain



Codes/Standards





- ASME A112.19.7/CSA B45.10
- CSA B45.5/IAPMO Z124
- ASTM E162
- ASTM E662
- UL 1795
- Greenguard UL 2818 - Gold
- CARB P2

KOHLER® One-Year Limited Warranty

See website for detailed warranty information.

Available Color/Finishes

Color tiles intended for reference only.

Color	Code	Description
	0	White
	96	Biscuit
	47	Almond
	NY	Dune
	G9	Sandbar

No change in measurements if connected with drain illustrated. (K-7161-AF)

 Recommended Faucet Location

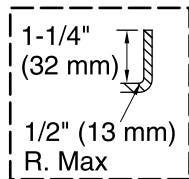

Integral Flange Detail

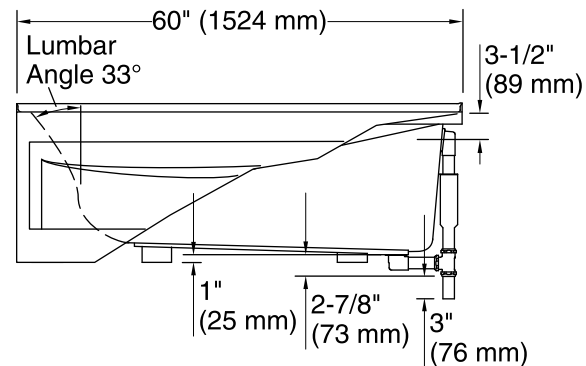
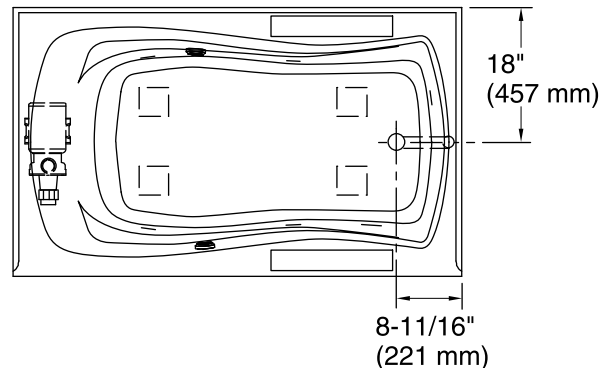
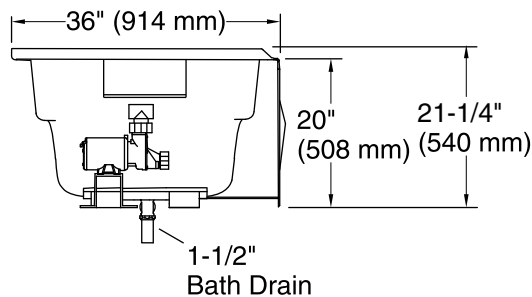

Required Electrical Service

One dedicated circuit required, protected with Class A Ground-Fault Circuit-Interrupter (GFCI) or Residual Current Device (RCD).

Pump, Heated 120 V, 15 A, 60 Hz
Surface:

Technical Information

All product dimensions are nominal.

Installation: 3-Wall Alcove
Drain location: Right
Basin area, bottom: 46" x 24" (1168 mm x 610 mm)
Basin area, top: 54" x 27" (1372 mm x 686 mm)
Weight: 111 lbs (50.3 kg)
Minimum floor load: 44 lbs/ft² (214.8 kg/m²)
Water depth: 14" (356 mm)
Water capacity: 63 gal (238.5 L)
Electrical component rating: Pump: 120 V, 7 A, 60 Hz
 Heated Surface: 120 V, 0.5 A, 60 Hz, 65 W
Pump speed: Single
Minimum flat for door: 2" (50 mm)

Notes

Measure your actual product for rough-in details.

Install this product according to the installation instructions.

The hot water supply should be 70% of the capacity of the bath or greater. Installations will vary.

Provide one grounded electrical outlet within 24" (610 mm) of each component.

If installing a rim-mount faucet, make sure there is no interference above or below the deck before drilling any holes.