



Features

- Integral flange.
- End drain.
- Slotted overflow for deep soaking.
- Bask™ heated surface creates spa-like relaxation with soothing warmth on your back, shoulders, and neck.
- Integral lumbar support and armrests for comfort.
- Integral apron with removable access panel.

Hydrotherapy

- 120 BubbleMassage™ airjets.
- Automatic purge cycles remove residual water from air channels after use.
- Built-in 300 W heater.
- Lighted keypad control.

Installation

- Alcove

Required Accessories

K-7271 Brass Slotted Overflow Bath Drain

or

K-7272 PVC Slotted Overflow Bath Drain

Recommended Accessories

K-1446 Remote Installation Kit

K-24916 Wireless Music Kit

K-9529 Removable Bath Seat



Codes/Standards

ASME A112.19.7/CSA B45.10

CSA B45.5/IAPMO Z124

ASTM E162

ASTM E662

UL 1795

Greenguard UL 2818 - Gold











CARB P2

KOHLER® One-Year Limited Warranty

See website for detailed warranty information.

Available Color/Finishes

Color tiles intended for reference only.

Color	Code	Description
	0	White
	96	Biscuit
	47	Almond
	NY	Dune
	95	Ice™ Grey
	G9	Sandbar
	33	Mexican Sand™
	K4	Cashmere
	58	Thunder™ Grey
	7	Black Black™

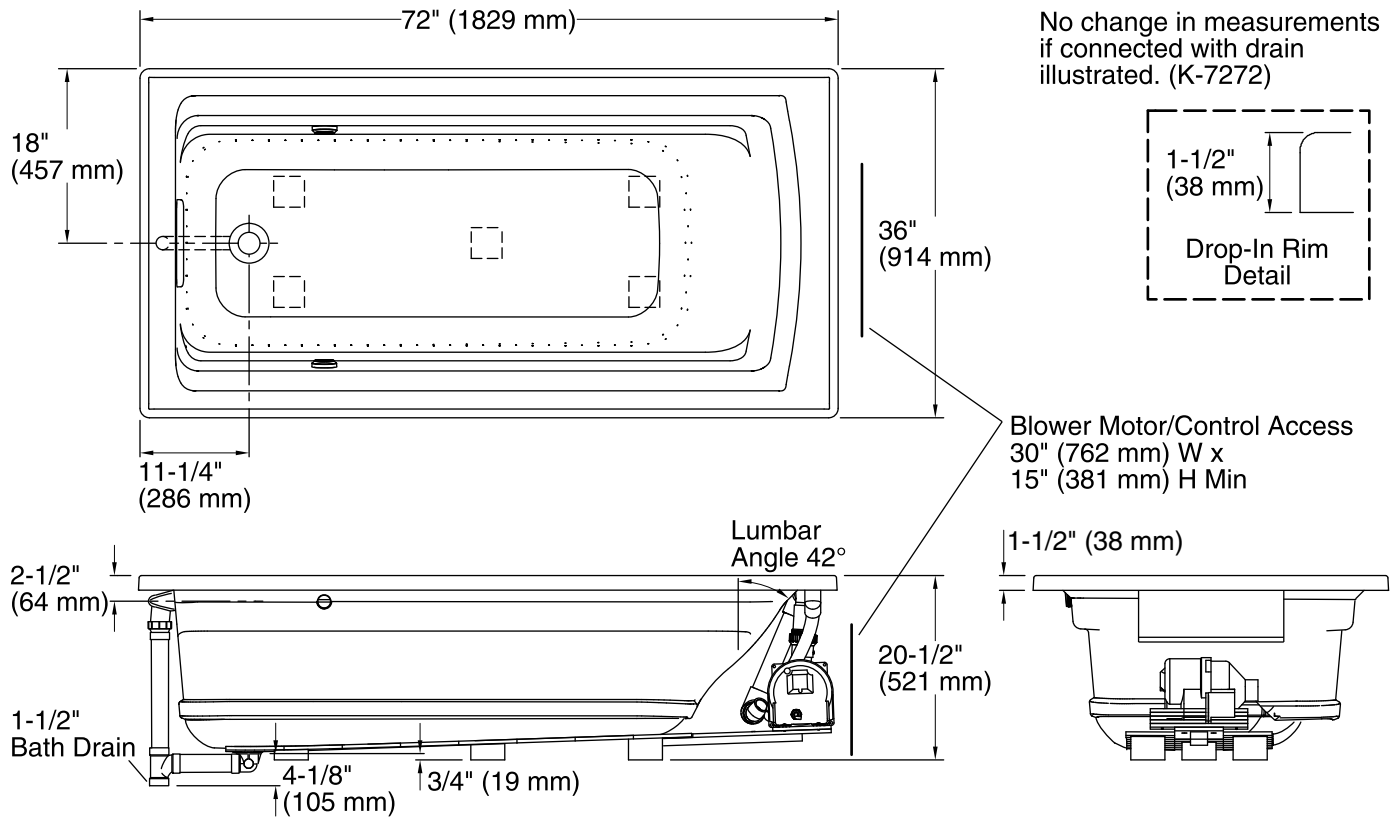

No change in measurements if connected with drain illustrated. (K-7272)

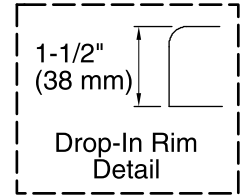

Blower Motor/Control Access
30" (762 mm) W x
15" (381 mm) H Min

Required Electrical Service

One dedicated circuit required, protected with Class A Ground-Fault Circuit-Interrupter (GFCI) or Residual Current Device (RCD).

Blower, Heated 120 V, 15 A, 60 Hz
Surface:

Technical Information

All product dimensions are nominal.

Installation:	Drop-in
Drain location:	End
Basin area, bottom:	51-3/8" x 21" (1305 mm x 533 mm)
Basin area, top:	64-1/2" x 30-1/2" (1638 mm x 775 mm)
Weight:	106 lbs (48.1 kg)
Minimum floor load:	41 lbs/ft ² (200.2 kg/m ²)
Water depth:	15" (381 mm)
Cutout:	Drop-in, 70-1/2" x 34-1/2" (1791 mm x 876 mm)
Electrical component rating:	Blower: 120 V, 10 A, 60 Hz, 300 W Heated Surface: 120 V, 0.5 A, 60 Hz, 65 W
Minimum flat for door:	1-9/16" (40 mm)

Notes

Measure your actual product for rough-in details.

Install this product according to the installation instructions.

The hot water supply should be 70% of the capacity of the bath or greater. Installations will vary.

Provide one grounded electrical outlet within 24" (610 mm) of each component.

Remote blower installation kit is available for relocating the blower. Provide access for servicing the blower.

Do not relocate or alter the PVC tee or coiled flexible tubing connected to the blower. Follow the blower relocation instructions exactly.