



### Features

- Left drain.
- Slotted overflow for deep soaking.
- Comfort Depth® design offers a 19" (483 mm) step-over height.
- Integral flange.
- VibrAcoustic® technology emits sound waves and offers a surround sound experience.
- Six transducers and a control amplifier with 25' (7.6 m) of wiring.
- High-resolution color screen in polished chrome.
- Integral apron with removable access panel.
- Integral lumbar support and armrests for comfort.
- Textured bottom surface.
- Coordinates with other products in the Archer® collection.
- 60" (1524 mm) x 32" (813 mm) x 20-1/4" (514 mm)
- Syncs with devices enabled with BLUETOOTH® wireless technology including smart phones, MP3 players, tablets and laptops located up to 33 feet away.\*

### Material

- Acrylic

### Installation

- Alcove

### Required Accessories

K-7271 Brass Slotted Overflow Bath Drain

or

K-7272 PVC Slotted Overflow Bath Drain

### Recommended Accessories

K-1491 Bath/Whirlpool Pillow

K-1601 Bath/Whirlpool Footstop



### ADA

### Codes/Standards

CSA B45.5/IAPMO Z124

ASTM E162

ASTM E662

UL 1795

CSA C22.2 No. 218.2

Greenguard UL 2818 - Gold

ADA

ICC/ANSI A117.1

CARB P2

### KOHLER® One-Year Limited Warranty





See website for detailed warranty information.

\*The BLUETOOTH® word mark and logos are registered trademarks owned by Bluetooth SIG, Inc. and any use of such marks by Kohler Co. is under license. Other trademarks and trade names are those of their respective owners.

### Available Color/Finishes

*Color tiles intended for reference only.*

#### Color Code Description

	0	White
	96	Biscuit
	47	Almond
	NY	Dune
	95	Ice™ Grey
	G9	Sandbar
	33	Mexican Sand™

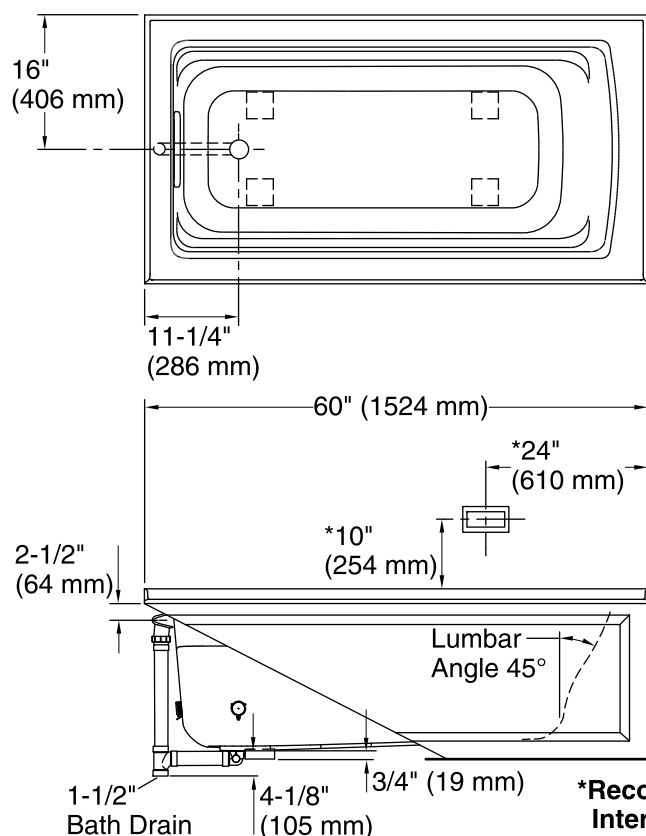

No change in measurements if connected with drain illustrated. (K-7272)

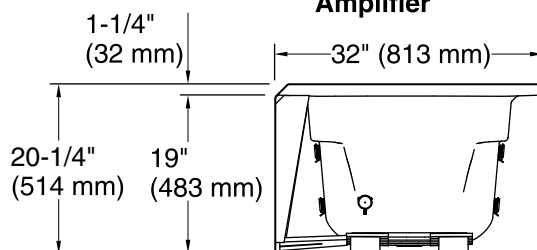
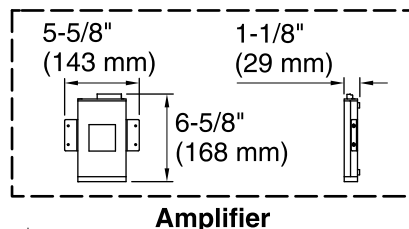
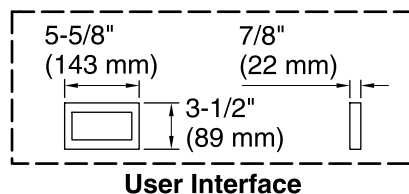
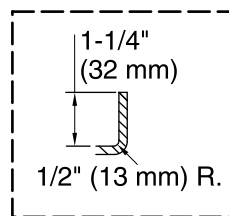

### Required Electrical Service

One circuit required, protected with Class A Ground-Fault Circuit-Interrupter (GFCI) or Residual Current Device (RCD).

Amplifier: 120 V, 15 A, 50/60 Hz

### Technical Information

All product dimensions are nominal.

Installation: 3-Wall Alcove

Drain location: Left

Basin area, bottom: 45-1/8" x 19-11/16" (1146 mm x 500 mm)

Basin area, top: 52-3/4" x 25-5/16" (1340 mm x 643 mm)

Weight: 91 lbs (41.3 kg)

Minimum floor load: 45 lbs/ft<sup>2</sup> (219.7 kg/m<sup>2</sup>)

Water depth: 15" (381 mm)

Water capacity: 58 gal (219.6 L)

Electrical component rating: Amplifier: 120 V, 1.1 A, 50/60 Hz

Amplifier channels: 2 at 15 W per channel

2 at 30 W per channel

Minimum flat for door: 2-3/16" (56 mm)

### Notes

Measure your actual product for rough-in details.

Install this product according to the installation instructions.

The hot water supply should be 70% of the capacity of the bath or greater. Installations will vary.

Provide one grounded electrical outlet within 24" (610 mm) of each component.

Control amplifier fits 16" (406 mm) center studs. 25' (7.6 m) cables are included.

ADA compliant when installed to the specific requirements of these regulations.