



### Features

- Right drain.
- Slotted overflow for deep soaking.
- Comfort Depth® design offers a 19" (483 mm) step-over height.
- Integral flange.
- VibrAcoustic® technology emits sound waves and offers a surround sound experience.
- Six transducers and a control amplifier with 25' (7.6 m) of wiring.
- High-resolution color screen in polished chrome.
- Integral apron with removable access panel.
- Integral lumbar support and armrests for comfort.
- Textured bottom surface.
- Coordinates with other products in the Archer® collection.
- 72" (1829 mm) x 36" (914 mm) x 19" (483 mm)

### Material

- Acrylic

### Installation

- Alcove

### Required Accessories

K-7271 Brass Slotted Overflow Bath Drain

or

K-7272 PVC Slotted Overflow Bath Drain

### Recommended Accessories

1184460 Kit, UI Mounting

K-1491 Bath/Whirlpool Pillow

K-1601 Bath/Whirlpool Footstop

K-9529 Removable Bath Seat



ADA

### Codes/Standards

CSA B45.5/IAPMO Z124

ASTM E162

ASTM E662

UL 1795

CSA C22.2 No. 218.2

Greenguard UL 2818 - Gold

ADA

ICC/ANSI A117.1









CARB P2

### KOHLER® One-Year Limited Warranty

See website for detailed warranty information.

### Available Color/Finishes

*Color tiles intended for reference only.*

Color	Code	Description
	0	White
	96	Biscuit
	47	Almond
	NY	Dune
	95	Ice™ Grey
	G9	Sandbar
	33	Mexican Sand™
	K4	Cashmere

No change in measurements if connected with drain illustrated. (K-7272)

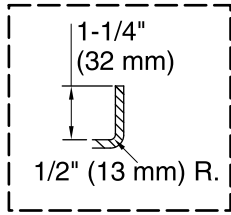

**Integral Flange Detail**

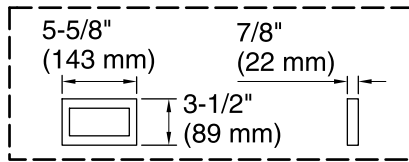

**User Interface**

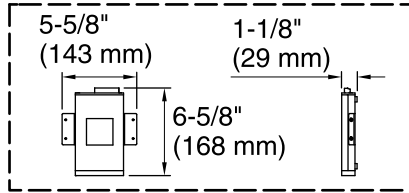

**Amplifier**

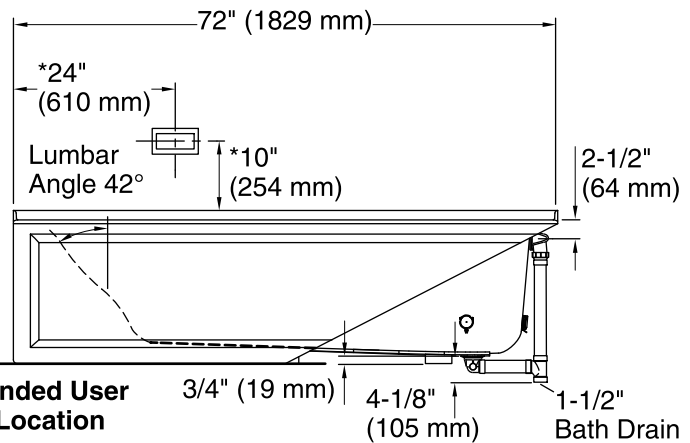
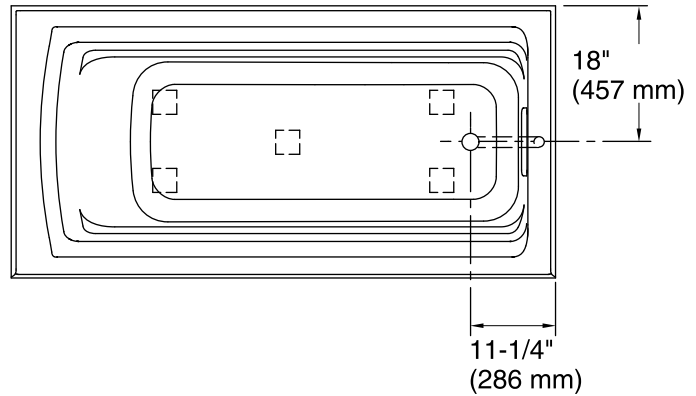
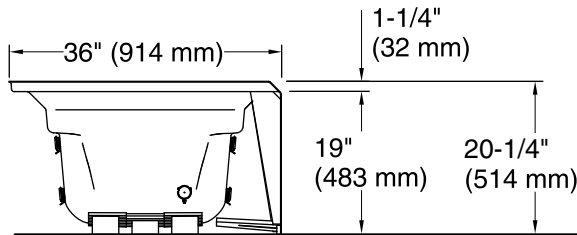

**\*Recommended User Interface Location**

### Required Electrical Service

One circuit required, protected with Class A Ground-Fault Circuit-Interrupter (GFCI) or Residual Current Device (RCD).

Amplifier: 120 V, 15 A, 50/60 Hz

### Technical Information

All product dimensions are nominal.

Installation: 3-Wall Alcove

Drain location: Right

Basin area, bottom: 51-3/8" x 21" (1305 mm x 533 mm)

Basin area, top: 64-1/2" x 30-1/2" (1638 mm x 775 mm)

Weight: 101 lbs (45.8 kg)

Minimum floor load: 41 lbs/ft<sup>2</sup> (200.2 kg/m<sup>2</sup>)

Water depth: 15" (381 mm)

Water capacity: 72 gal (272.5 L)

Electrical component rating: Amplifier: 120 V, 50/60 Hz

Minimum flat for door: 1-9/16" (40 mm)

### Notes

Measure your actual product for rough-in details.

Install this product according to the installation instructions.

The hot water supply should be 70% of the capacity of the bath or greater. Installations will vary.

Provide one grounded electrical outlet within 24" (610 mm) of each component.

Control amplifier fits 16" (406 mm) center studs. 25' (7.6 m) cables are included.

ADA compliant when installed to the specific requirements of these regulations.