

Features

- Frameless design highlights showering area.
- Innovative roller design simplifies installation and provides out-of-plumb adjustability.
- Frameless, 1/4" (6 mm) thick frosted Crystal Clear glass.
- Door tracking system features a hidden, cushioned, center guide for smooth, quiet sliding action.
- Smooth, easy-to-clean wall jambs.
- Gently curved towel bars inside and out complete the look of this door.
- CleanCoat® technology creates a barrier between the water and glass to help keep your shower door looking new.

Material

- Anodized aluminum prevents rusting or corrosion.
- Tempered glass ensures maximum safety and durability.

Installation

- Out-of-plumb adjustability allows for simpler installation.
- Can be installed to open to the left or right.

Components

Additional included component/s: Hardware kit.



Codes/Standards

CPSC 16CFR 1201
ANSI Z97.1 (Tempered Glass)

KOHLER® One-Year Limited Warranty

See website for detailed warranty information.

Available Color/Finishes

Color tiles intended for reference only.

Color	Code	Description
	SH	Bright Silver
	MX	Matte Nickel
	ABV	Anodized Brushed Bronze
	ABZ	Anodized Dark Bronze

Available Glass Options

Code	Description
L	Crystal Clear

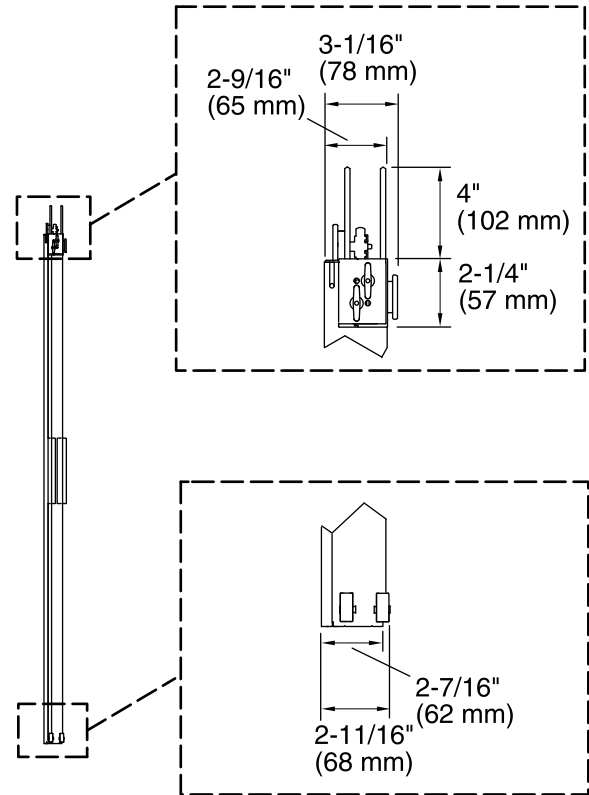
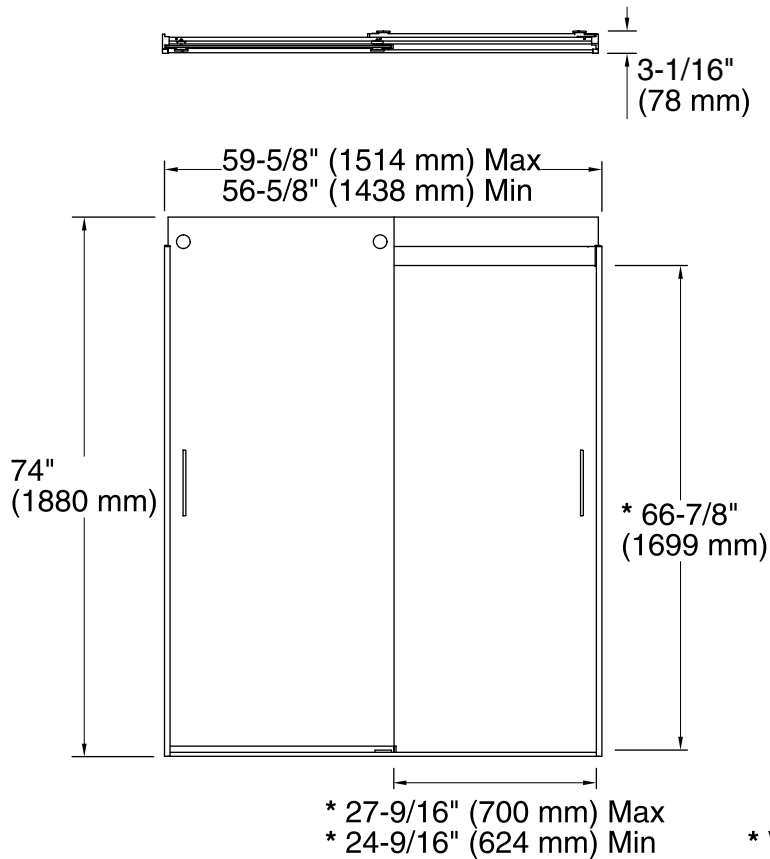

*** Walk-through**

Technical Information

All product dimensions are nominal.

Installation type: For shower base installation

Opening style: Sliding/Bypass

Opening Width - Min: 56-5/8" (1438 mm)

Opening Width - Max: 59-5/8" (1514 mm)

Walk-through - Min: 24-9/16" (624 mm)

Walk-through - Max: 27-9/16" (700 mm)

Glass thickness: 1/4" (6 mm)

Glass coating: CleanCoat®

Notes

Install this product according to the installation guide.

If replacing a shower door, the narrow wall jamb design of this door may not cover the existing shower door holes.

The vertical opening should be a minimum of 76-1/2" (1943 mm) to allow for installation clearance.