

**Finesse™ Quick Install™**  
Frameless Sliding Shower Door  
**5375EZ-45**

**Features**

- Complete door installs within minutes.
- Pre-installed rollers for smooth, silent operation.
- Frameless design highlights showering area.
- Frameless, 1/4" (6 mm) thick tempered glass.
- Center-guided mechanism for smooth, quiet sliding action and easy cleaning.
- CleanCoat® technology creates a barrier between the water and glass to help keep your shower door looking new.
- Wide variety of finishes and glass patterns.
- Inside and outside towel bars complete the look of this door.

**Material**

- Anodized aluminum prevents rusting or corrosion.
- Tempered glass ensures maximum safety and durability.

**Installation**

- Out-of-plumb adjustability allows for simpler installation.
- Can be installed to open to the left or right.
- Quick Install® compression fit technology means no cutting or drilling needed.

**Components**

Additional included component/s: Hardware kit, and hex wrench.



**Codes/Standards**

ANSI Z97.1 (Tempered Glass)  
CPSC 16CFR 1201

**STERLING® Warranty - Bath and Shower Doors**

See website for detailed warranty information.

**Available Color/Finishes**

*Color tiles intended for reference only.*

Color	Code	Description
	DR	Deep Bronze
	N	Nickel
	S	Silver

**Available Glass Options**

Code	Description
	Clear
	Lake Mist™

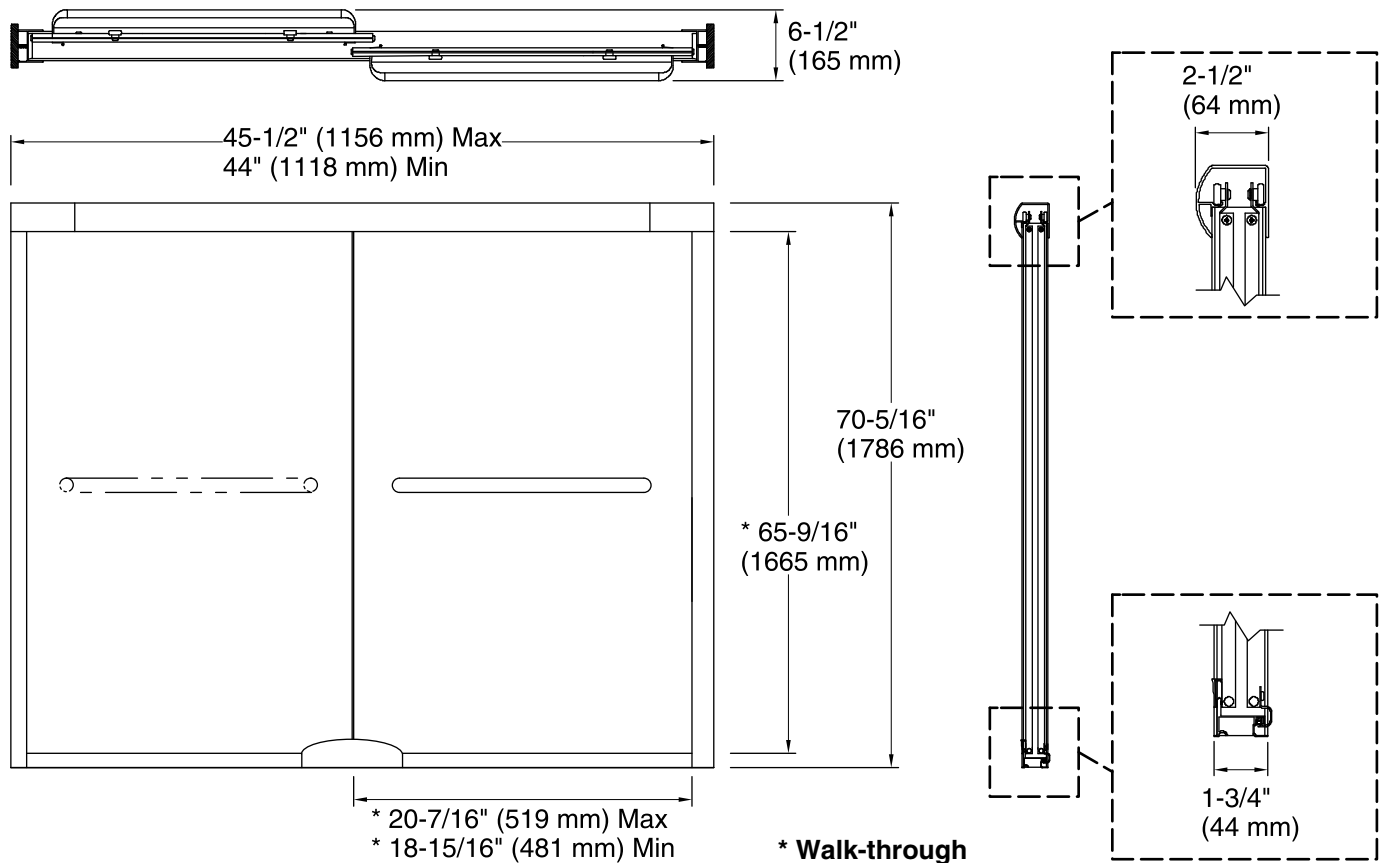

**Technical Information**

All product dimensions are nominal.

Installation type: For shower base installation

Opening Width - Min: 44" (1118 mm)

Opening Width - Max: 45-1/2" (1156 mm)

Walk-through - Min: 18-15/16" (481 mm)

Walk-through - Max: 20-7/16" (519 mm)

Glass thickness: 1/4" (6 mm)

Glass coating: CleanCoat®

**Notes**

Install this product according to the installation guide.

The vertical opening should be a minimum of 72-5/16" (1837 mm) to allow for installation clearance.