



Ceramic/Impressions®

Vanity Top Bathroom Sink
K-2777-1

Features

- Vitreous China
- Integrated top and bowl
- With overflow
- Single faucet hole
- 25" (636 mm) x 22-3/8" (568 mm)



Codes/Standards







ASME A112.19.2/CSA B45.1

KOHLER® One-Year Limited Warranty

See website for detailed warranty information.

Available Color/Finishes

Color tiles intended for reference only.

| Color | Code | Description |
|--|------|--------------------------|
|  | G81 | White Impressions |
|  | G82 | Dune Impressions |
|  | G83 | Biscuit Impressions |
|  | G85 | Sandbar Impressions |
|  | G86 | Cashmere Impressions |
|  | G88 | Thunder Grey Impressions |

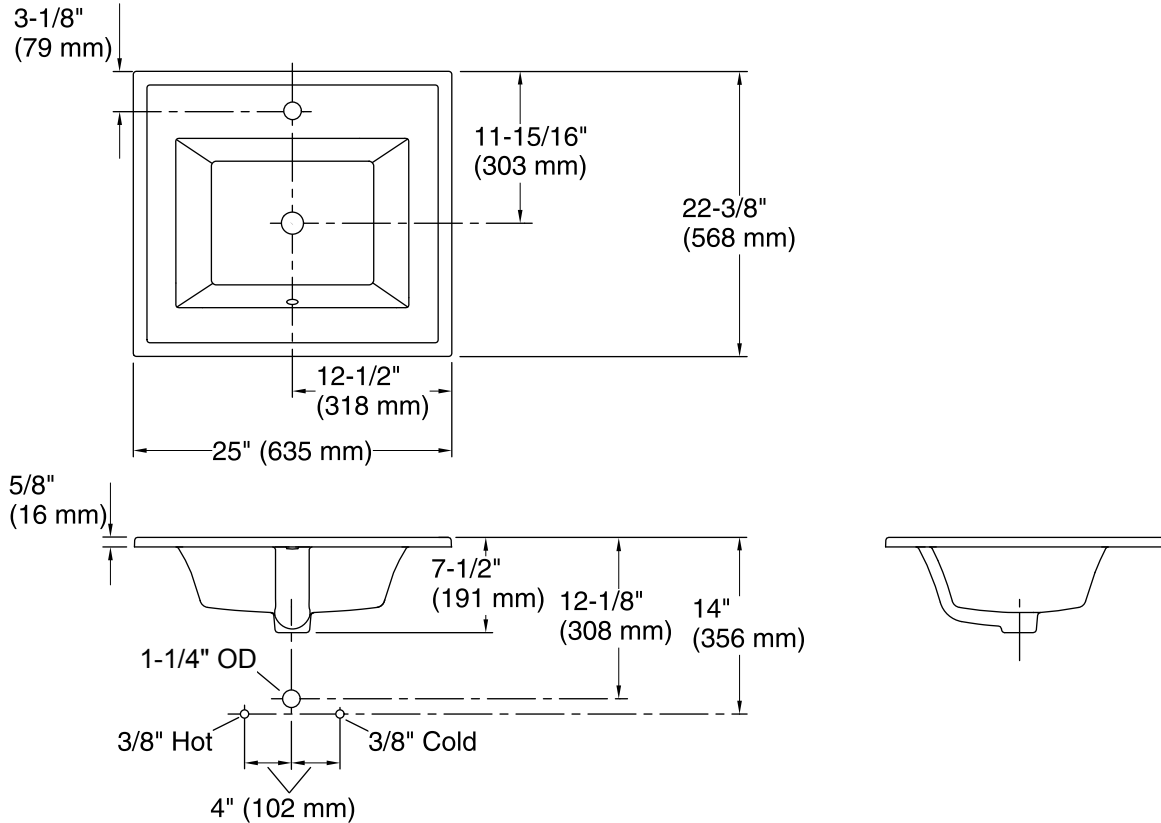

Technical Information

All product dimensions are nominal.

| | |
|-----------------------|--|
| Bowl configuration: | Single |
| Installation: | ITB |
| Bowl area (Only) | Length: 17-1/8" (436 mm) Width: 13-3/8" (340 mm) Bowl depth: 5-1/2" (140 mm) Water depth: 4" (102 mm) |
| Number of deck holes: | 1 |
| Faucet hole(s): | 1-3/8" (35 mm) |
| Drain hole: | 1-3/4" (44 mm) |

Notes

Install this product according to the installation instructions.

This sink is designed to be installed as an integrated vanity top to a KOHLER or standard vanity.