

Features

- Frameless, 1/4" (6 mm) thick Crystal Clear tempered glass.
- Cushioned center guide provides smooth, quiet sliding action.

Technology

- Innovative roller design simplifies installation and provides out-of-plumb adjustability while glass is installed.
- Vertical blade handles accentuate the contemporary style.
- CleanCoat® nanotechnology provides a smooth, nonstick surface to help prevent buildup of water stains, bacteria and mildew on your glass, to make it easy to clean and keep it looking like new.

Installation

- Sliding shower door.
- Not for use in hospitality.

Recommended Products/Accessories

K-23723 Faucet cleaner

Included Components

Additional Components:

Hardware kit



Codes/Standards

CPSC 16CFR 1201
ANSI Z97.1

KOHLER® One-Year Limited Warranty

See website for detailed warranty information.

Available Colors/Finishes

Color tiles intended for reference only.

Color	Code	Description
	SH	Bright Silver
	MX	Matte Nickel
	ABV	Anodized Brushed Bronze
	ABZ	Anodized Dark Bronze

Available Glass Options

Code	Description
L	Crystal Clear

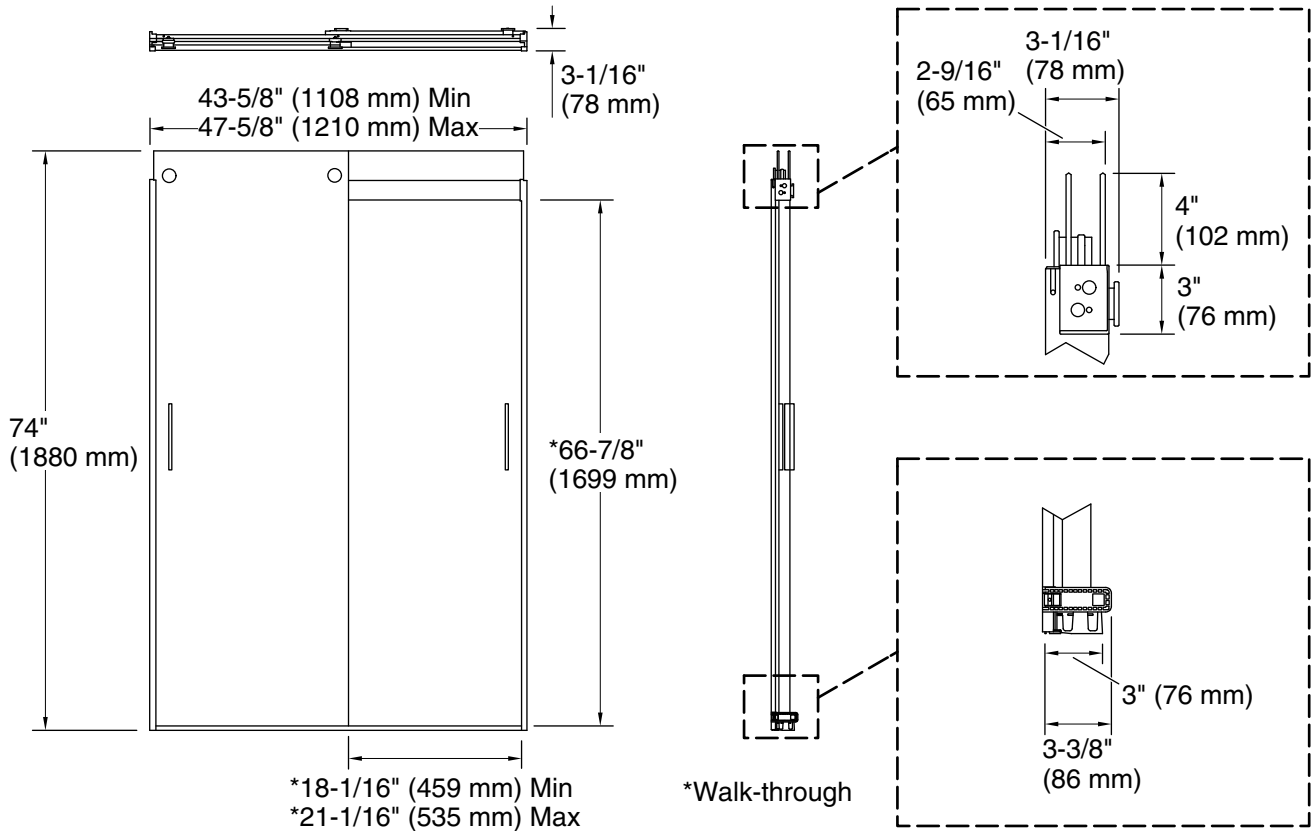

Technical Information

All product dimensions are nominal.

Installation type: For shower base installation

Opening style: Sliding/Bypass

Opening Width - Min: 43-5/8" (1108 mm)

Opening Width - Max: 47-5/8" (1210 mm)

Walk-through - Min: 18-1/16" (459 mm)

Walk-through - Max: 21-1/16" (535 mm)

Base-To-Wall Radius 1/2" (13 mm)

– Max:

Glass thickness: 1/4" (6 mm)

Glass coating: CleanCoat®

Notes

Install this product according to the installation guide.

If replacing a shower door, the narrow wall jamb design of this door may not cover the existing shower door holes.

The vertical opening should be a minimum of 76-1/2" (1943 mm) to allow for installation clearance.