



Inia™ Wading Pool®

Bathroom Sink
K-2773

Features

- Without overflow.
- 20-5/8" (524 mm) x 14-15/16" (379 mm)

Material

- Glass

Installation

- Drop-in installation.

Components

Additional included component/s: Drain Gasket Kit 1197255.



ADA

Codes/Standards





CSA B45.11/IAPMO Z401
ADA
ICC/ANSI A117.1

KOHLER® One-Year Limited Warranty

See website for detailed warranty information.

Available Color/Finishes

Color tiles intended for reference only.

Color	Code	Description
	B11	Ice
	TG1	Translucent Dusk
	TG2	Translucent Dew
	TG3	Translucent Doe
	TG6	
	TG7	
	TG8	

USA/Canada: 1-800-4KOHLER (1-800-456-4537)

Kohler Co. reserves the right to make revisions without notice to product specifications.

For the most current Specification Sheet, go to www.kohler.com.

11-21-2016 03:09

THE BOLD LOOK
OF **KOHLER**®

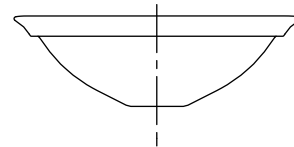
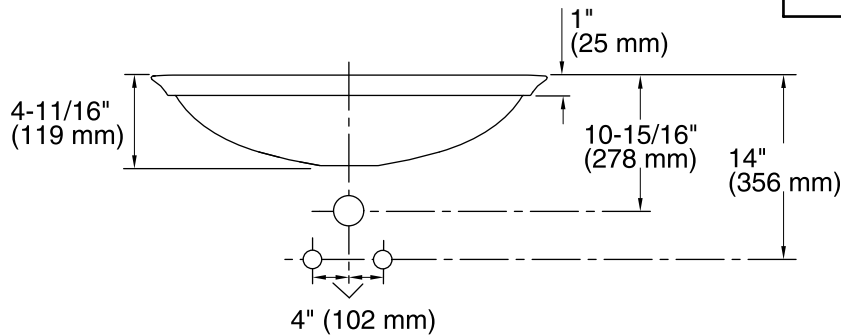
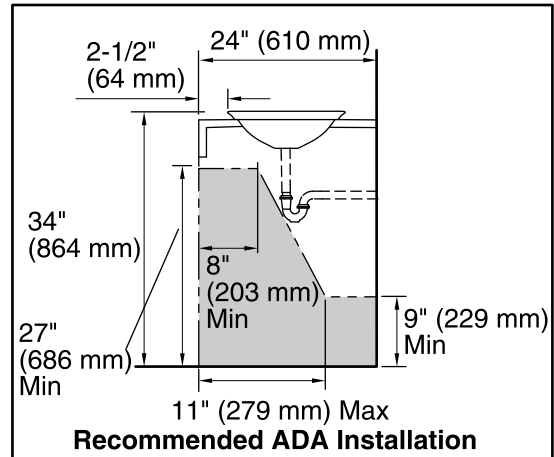
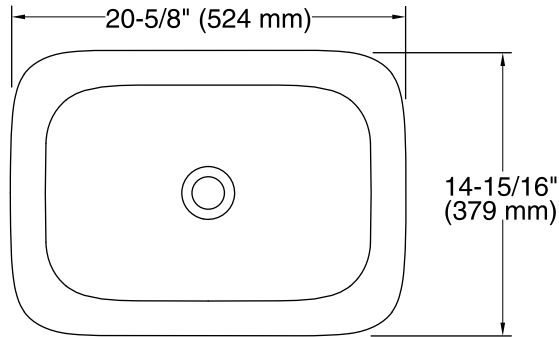

Technical Information

All product dimensions are nominal.

Installation: Vessel

Template: 1190263-7, not required, included

Notes

Install this product according to the installation instructions.

Product does not have an overflow.

NOTICE: Countertop manufacturer or cutter must use the cut-out template provided with the product, or a current one provided by Kohler Co. (call 1-800-4KOHLER). Kohler Co. is not responsible for cut-out errors when the incorrect cut-out template is used.

Product must be installed with the supplied drain gasket kit.

ADA compliant when installed to the specific requirements of these regulations.