



Features

- Freestanding design creates a striking focal point in your bathing area.
- 16" soaking depth.
- Center drain.
- Bask® heated surface creates spa-like relaxation with soothing warmth on your back, shoulders, and neck.
- Integral lumbar support.
- Textured bottom surface.
- Wide ledge on one side is ideal for deck-mount faucet and/or handshower.
- 65-1/2" (1664 mm) x 35-1/2" (902 mm) x 24-1/2" (622 mm)

Material

- Acrylic

Hydrotherapy

- Fully adjustable volume above and below the water.
- Six original instrumental compositions offer different levels of relaxation.
- Six transducers and a control amplifier with 25' (7.6 m) of wiring.
- VibrAcoustic® technology emits sound waves and offers a surround sound experience.

Installation

- Freestanding
- PureFlo drains are not recommended for a deck-mount faucet installation

Recommended Accessories

- K-7213 27" Cable Bath Drain
- K-7265 Clearflo Bath Drain
- K-37380 30" Rough-in Cable Bath Drain
- K-37383 30" Rough-in Cable Bath Drain
- K-37386 30" Rough-in Cable Bath Drain



Codes/Standards



CSA B45.5/IAPMO Z124
UL 1795
CSA C22.2 No. 218.2
Greenguard UL 2818 - Gold
CARB P2

KOHLER® One-Year Limited Warranty

See website for detailed warranty information.

Available Color/Finishes

Color tiles intended for reference only.

Color	Code	Description
	0	White
	96	Biscuit

No change in measurements if connected with drain illustrated. (K-7213)

■ Faucet area.

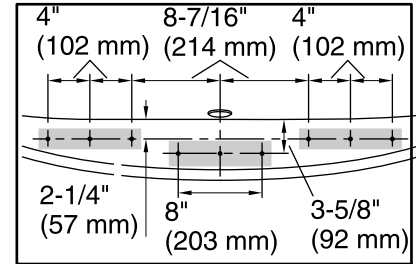
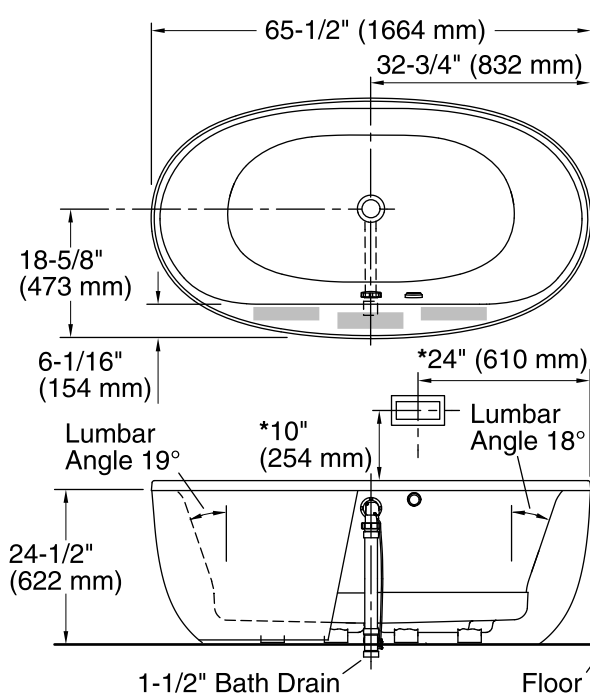

**Faucet Hole Locations
(For KOHLER® Brand Only)**

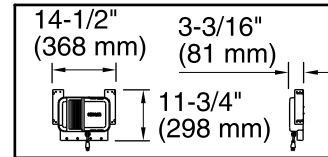

Control Amplifier

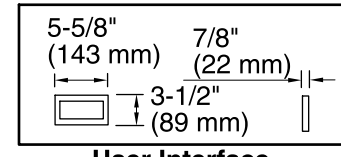

User Interface

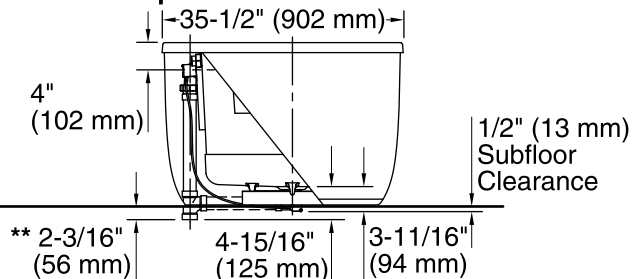

***Recommended User Interface Location**

** Allow for appropriate clearance in subfloor for drain clearance.
Note: Horizontal PVC pipe and tee shown, not included.

Required Electrical Service

One circuit required, protected with Class A Ground-Fault Circuit-Interrupter (GFCI) or Residual Current Device (RCD).

Heated Surface, 120 V, 15 A, 60 Hz

Amplifier:

Technical Information

All product dimensions are nominal.

Installation:	Freestanding
Drain location:	Center
Basin area, bottom:	45-3/4" x 24-7/8" (1162 mm x 632 mm)
Basin area, top:	54-7/8" x 29-3/16" (1394 mm x 741 mm)
Weight:	91 lbs (41.3 kg)
Minimum floor load:	40.4 lbs/ft ² (197.3 kg/m ²)
Water depth:	16" (406 mm)
Water capacity:	72.6 gal (274.8 L)
Template:	Footprint, 1244408-7, not required, not included
Electrical component rating:	Heated Surface: 120 V, 0.5 A, 50/60 Hz, 65 W Amplifier: 120 V, 1 A, 50/60 Hz, 15 W
Minimum flat for door:	0" (0 mm)

Notes

Measure your actual product for rough-in details.

Install this product according to the installation instructions.

The hot water supply should be 70% of the capacity of the bath or greater. Installations will vary.

Provide one grounded electrical outlet within 24" (610 mm) of each component.

Control amplifier fits 16" (406 mm) center studs. 25' (7.6 m) cables are included.

Provide a separate grounded outlet if connecting to a powered wireless device or adapter.