



Meubles de Qualité à prix Abordable
Affordable Quality Home Furniture

**CHAISE D'APPOINT TISSU " CHEVRON "
SARCELLE/MÉTAL CHROMÉ**

**TEAL " CHEVRON " FABRIC / CHROME METAL
ACCENT CHAIR**

I 8136

**INSTRUCTIONS D'ASSEMBLAGE
ASSEMBLY INSTRUCTIONS**

MONARCH SPECIALTIES INC.





**POUR DE L'ASSISTANCE OU POUR COMMANDER
DES PIÈCES CONTACTEZ NOTRE DÉPARTEMENT
DE SERVICE À LA CLIENTÈLE.**

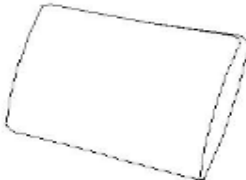

**FOR ASSISTANCE OR TO ORDER PARTS
CONTACT OUR CUSTOMER SERVICE DEPARTMENT**

WWW.MONARCHSERVICE.COM

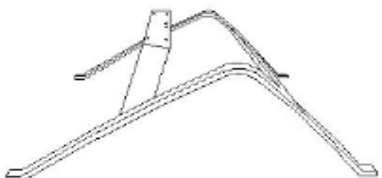
IDENTIFICATION DES PIÈCES
PARTS IDENTIFICATION

1		DOSSIER BACK REST	1MC 1PC
2		COUSSIN DE SIÈGE CUSHION SEAT	1MC 1PC
3		FIXATION D'ATTACHE CONNECTING BRACKET	1MC 1PC
4		CADRE DU SIÈGE SEAT FRAME	1MC 1PC

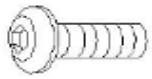
IDENTIFICATION DES PIÈCES DE MONTAGE
HARDWARE IDENTIFICATION

A		M8 X 16 MM	2MCX / 2PCS
B		M8 X 25 MM	10MCX / 10PCS
C		M5	1MC / 1PC

ÉTAPE / STEP 1

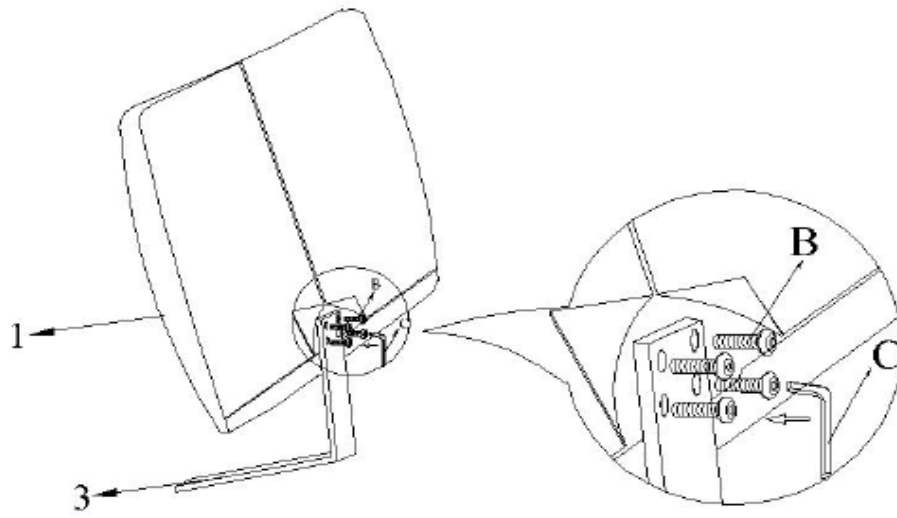

ÉTAPE / STEP 2

