

INSTALLATION INSTRUCTIONS

5-in x 84-in x 3/8-in
12.7 cm x 213.36 cm x 9.525 mm

10 planks | 29 sq.ft.

IMPORTANT INFORMATION

- Open cartons 2-3 days prior to the install and allow material to adjust to the relative humidity in the space where it will be installed. Maintain consistent humidity levels after installation.
- For the best finished appearance, mix planks from multiple cartons while installing.
- Ensure proper gaps are maintained around the perimeter of the room and all obstructions.
- Ensure the surface is level and planks are able to slide freely within their clips.
- This is a floating ceiling and planks should not be attached directly to trim, molding or walls in a ceiling application.
- Never span more than 21-ft without an expansion joint (cover with trim).

WoodHaven™ Ceiling Plank Installation Instructions

We are constantly working to improve our instructions with learnings from customers like you. If you need additional guidance, call our Techline at 1-877-ARMSTRONG (276-7876).

We recommend installing WoodHaven™ planks using the Easy Up® track and clip system. However, the clips and screws included in the box, when used with furring strips and shims, are suitable for installations that meet the following conditions:

- Ceiling surface is easily leveled with furring strips and shims.
- Room will not experience broad humidity and temperature differences from season to season.
- Planks installed on non-flat ceilings, such as vaulted or cathedral ceilings. **If you have a sloped surface (not covered in these instructions) contact Techline at 1-877-ARMSTRONG (276-7876) for guidance.**

WoodHaven Planks can also be installed on 15/16-in ceiling grid, using the Easy Up® Clips in accordance with these instructions.

Space Considerations – Before You Begin

- The system is a floating system that allows for natural movement of a home. Ensure that the surface is level and planks are able to slide freely within their clips. Unlike lumber, which can twist and warp, this system does not require nails/screws at each edge to stay flat.
- Never span more than 21-ft without an expansion joint (cover with trim). **NOTE:** do not attach the planks directly to trim, molding, or wall.
- Open cartons 2-3 days prior to the install and allow material to adjust to the relative humidity in the space where it will be installed. Maintain consistent temperature and humidity levels after installation. See appropriate indoor temperature and humidity conditions for this product in the warranty.
- For the best finished appearance, mix planks from multiple cartons while installing.
- Installation must not be direct to exterior roof joist. Furring strips or Easy Up® tracks will provide the required 1/2-in gap between planks and above surface. Do not allow anything to touch the back of the planks, such as insulation.
- Planks should not be installed below embedded radiant heat coils.
- Allow for a 1/4-in gap around all columns, beams and obstructions.
- Plan for lighting or other fixtures that may be included in your room:
 - Mount electrical boxes so they are 3/8-in lower than the surface to which you will attach planks. (Remember to add for height of Easy Up track (1/2-in) or furring strip. With Easy Up tracks, total drop will be 7/8-in).
 - Use light fixtures that will not raise the temperature of the planks above 230° Fahrenheit to prevent discoloration of the plank. Contact the lighting manufacturer for any questions about the amount of heat generated by the light.
 - Allow for a 1/4-in of space around the perimeter of the fixture, to be covered by the fixture trim or facer.
- **Uncertain of how these considerations impact your project—call for guidance at 1-877-ARMSTRONG (276-7876).**

Safety

- **CAUTION: Wood Dust.** Sawing, sanding and machining wood products can produce dust. Airborne wood dust can cause respiratory, eye and skin irritation. Establish and maintain adequate ventilation in the work area.
- Wear long-sleeve clothing and gloves.
- Wear safety glasses to minimize the risk of eye injury.
- Store cutting equipment properly when not in use.
- Follow manufacturer's instructions when working with adhesives for beaded plank installation. Armstrong does not guarantee the performance of adhesives.

Maintenance Hints

- Wipe with a damp cloth

Tools Needed:

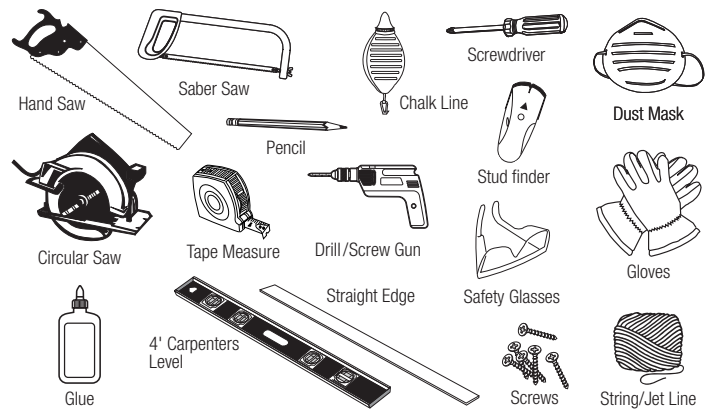

- For can lights/ceiling inserts: jig saw or dremel
- Crown molding >1.5-in
- Be sure to follow the manufacturer's recommendations when using power tools.
- **For WoodHaven™ Plank with Easy Up® track and clips instructions only:** Armstrong® Easy Up® tracks and clips.
- **For WoodHaven Plank Clips and Screws instructions only:** also add furring strips and shims.

Installing WoodHaven™ Planks with Easy Up® tracks and clips:

LARGE CEILING REQUIREMENT

Easy Up® Expansion Joint

If your ceiling installation is greater than 21-ft in the length direction of the WoodHaven™ planks, an expansion joint is required. You will need to plan this detail into the ceiling layout. Expansion joints can be placed more frequently than 21-ft to achieve a balanced visual. *A drawing of this detail is shown below.*

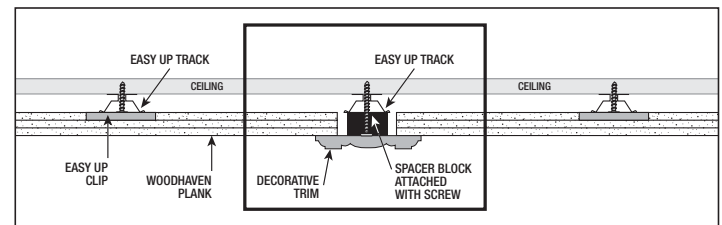

Locate where you will place your expansion joint. This joint will run parallel to the other Easy Up® tracks. Mark the expansion joint location and install a row of Easy Up track along those marks. The track should be installed end to end. A small gap between the ends is acceptable. Next, use a WoodHaven plank to create a spacer for the expansion joint. Rip down a WoodHaven plank into 7/8-in wide strips. One plank should yield about 5 spacers. Attach these strips to the face of the installed Easy Up track with screws. Countersink the screws so they do not interfere with the next step. Leave a 1/2-in gap between the ends of these strips. The final step in creating the expansion joint will take place once the ceiling is installed. When installing WoodHaven planks, they should be cut to leave a 1/2-in gap on either side of the expansion joint spacer piece. After all the WoodHaven ceiling planks are installed, finish off the expansion joint with a 2-1/2-in or wider piece of decorative trim or molding (available from other manufacturers). Pre-painting the decorative trim will help keep your ceiling installation clean. This trim should be attached to the expansion joint assembly using finishing nails. Putty and touchup paint as needed.

NOTE: Easy up track should be installed within 6-in of either side of an expansion joint. This track will support the WoodHaven ceiling.



photo A

GENERAL INSTALLATION

In this example, we are installing WoodHaven planks with Easy Up track and clips over unfinished drywall. You can also install planks direct to floor joists or studs, or other existing ceilings, using the same Easy Up® tracks.

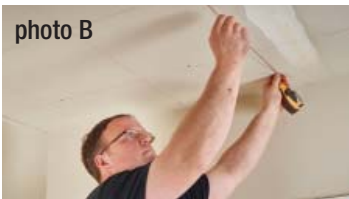

photo B

When installing directly to an existing ceiling, find joists and mark with chalk line. **(photo A)**

Running perpendicular to the joists, mark where tracks will be placed. Start 2-in from the starting wall. Spacing is 24-in on center or less.

(photo B)

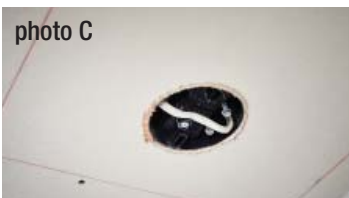

photo C

Ensure that you do not have tracks running directly over light fixture holes or other ceiling obstructions. Adjust tracks by reducing space between tracks (never greater than 24-in spacing.) **(photo C)**



photo D

Screw first Easy Up track, making screw connections at each joist location. Start on your mark, 2-in from the parallel wall, with the end of the track against the perpendicular wall. **(photo D)**



photo E

Attach second track. No need to place end-to-end. Simply overlap tracks, side-by-side, by at least 1-in. Leave a 1/8-in gap between tracks. **(photo E)**

If you need to cut track pieces shorter, use a chop saw or hack saw. Ensure you have the right blade for metal. Do not crush track, as clips would not fit. And remember your protective safety glasses and cut resistant gloves.



photo F

It is imperative to level your tracks. Simply use a bubble level and insert shims (loosen screw and tighten to get a level track). Check both levels in the direction of the track (parallel), as well as across tracks (perpendicular.) **(photo F)**



photo G

Continue screwing tracks to joists in the ceiling. At the finishing wall, install the last track 2-in away from the wall. **(photo G)**

(In this picture, note that the installers didn't have to cut any metal pieces. Overlapping the track by more than an inch is fine!)

Determine Your Layout and Size of Your Border Planks. Measure the length of the room, in the direction of your tracks, and opposite the joists, to determine the size of your border planks.

	Example:	Your Room:
1. Total room length	Room = 178"	_____
2. Divide total by 5"	$178" \div 5" = 35.6$	_____
3. Multiply the remainder by 5"	$0.6 \times 5" = 3"$	_____
4. Add 5" to the result	$3" + 5" = 8"$	_____
5. Divide results by 2	$8" \div 2 = 4"$	_____
6. This is your border plank width	Border plank width = 4"	_____

This is your first row of planks.



photo H

Cut the "tongue" side off of the length of the plank for your first border plank. **TIP:** Using a table saw or circular saw helps to ensure a clean straight line. **(photo H)**



photo I

Leaving 3/4-in from the starting wall (closest to the end of the plank), screw the 1st border plank in the center of the plank right up against your starting wall, with one screw connecting with the track. **(photo I)**

Only use one screw to hold the plank in place while you move the Easy Up® clips into the groove edge of the plank. Your future molding will hold the planks in place. **TIP:** Another option is to use three finish nails as a ledge, located directly under the face of the plank, on which you can rest the plank while you slide the clips into place.



photo J

Snap an Easy Up Clip onto every track. **(photo J)**



photo K

Slide the clip on the track until it connects with the "Groove" of the plank. The clip should loosely hold the upper edge of the groove on the plank. **(photo K)**



photo L

Continue to build your ceiling by connecting the tongue and groove on the long side and end of the plank. Ensure a 3/4-in gap* on finishing wall to allow for expansion. This will be covered by molding. **(photo L)**

**A 7-ft plank can expand/contract as much as 1/4-in under extreme humidity changes. This gap allows for normal expansion and will be covered by molding. Consistent humidity levels must be maintained after installation.*

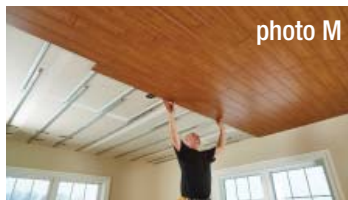

photo M

Lay out the room with staggered seams. In most installations, you should be able to use the leftover cut plank from one row to start the next row, with very little waste. Do not use planks smaller than 26-in to ensure attachment with two clips. **(photo M)**



photo N

The tongue of the new plank will slide into the groove of the receiving plank, hiding the Easy Up clip.



photo O

Double check your math for the width of the last plank. Measure the remaining distance to the wall, and cut off the groove edge of the plank to fit the space. There should be a 3/4-in gap at the border. Tip the tongue of the plank into the groove of the receiving plank. **(photo N)**

Support the last plank by either screwing it to the Easy Up track with a single screw **(TIP:** Pre-drilling helps) or create a ledge using finishing nails hammered every 24-in into the wall directly below the face. (Molding will hide screw or nails) **(photo O)**

We recommend finishing the job with crown molding (not sold by Armstrong Ceilings), painted to match other trim in your space.

A slightly damp rag will remove any dust from your install, leaving you with a beautiful new ceiling.

Installing WoodHaven™ Planks Directly to Ceiling Joists with Furring Strips and WoodHaven Clips:

LARGE CEILING REQUIREMENT Furring Strip Expansion Joint

If your ceiling installation is greater than 21-ft in the length direction of the WoodHaven™ planks, an expansion joint is required. You will need to plan this detail into the ceiling layout. Expansion joints can be placed more frequently than 21-ft to achieve a balanced visual. **A drawing of this detail is shown below.**

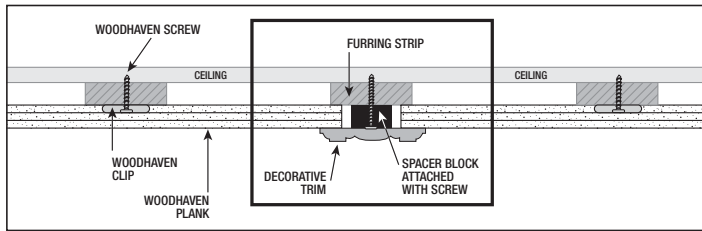

Locate where you will place your expansion joint. This joint will run parallel to the other furring strips. Mark the expansion joint location and install a row of furring strips along those marks. The furring strips should be installed end to end with a 1/2-in gap between the ends. Next, use a WoodHaven plank to create a spacer for the expansion joint. Rip down a WoodHaven plank into 7/8-in wide strips. One plank should yield about 5 spacers. Attach these strips to the face of the installed furring strip with screws. Countersink the screws so they do not interfere with the next step. Leave a 1/2-in gap between the ends of these strips. The final step in creating the expansion joint will take place once the ceiling is installed. When installing WoodHaven planks, they should be cut to leave a 1/2-in gap on either side of the expansion joint spacer piece. After all the WoodHaven ceiling planks are installed, finish off the expansion joint with a 2-1/2-in or wider piece of decorative trim or molding (available from other manufacturers). Pre-painting the decorative trim will help keep your ceiling installation clean. This trim should be attached to the expansion joint assembly using finishing nails. Putty and touchup paint as needed.

NOTE: Furring strips should be installed within 6-in of either side of an expansion joint. These strips will support the WoodHaven ceiling.

GENERAL INSTALLATION

Locate ceiling joists if not exposed. Tap on the plaster or drywall ceiling until you hear a solid thud, or use a stud finder. Generally, joists are spaced 16-in or 24-in on center. If not exposed, mark with a chalk line. Level and attach furring strips perpendicular to the joists, starting 2-in from the first wall. Spacing should not exceed 24-in on center. **If you have a sloped surface (not covered in these instructions) contact Techline at 1-877-ARMSTRONG (276-7876) for guidance.**

Determine Border Plank Size for a Balanced Appearance

	Example:	Your Room:
1. Measure room width same direction as the joists	Room = 178"	_____
2. Divide by 5"	$178" \div 5" = 35.6$	_____
3. Multiply the remainder by 5"	$0.6 \times 5" = 3"$	_____
4. Add 5" to the result	$3" + 5" = 8"$	_____
5. Divide result by 2	$8" \div 2 = 4"$	_____
6. Record your border plank width	Border plank width = 4"	_____

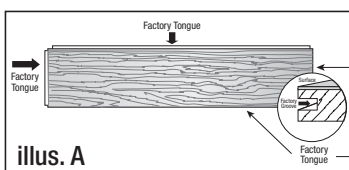

illus. A

Install Planks Snap a Chalk Line

1. Measure the calculated border plank width and snap a chalk line at that distance from the front wall.

Cut First Border Plank

1. Familiarize yourself with the plank edges and face before you begin cutting your first plank. (illus. A)
2. Cut the first row of plank to the border plank width, removing the tongue edge. **TIP:** Using a table saw or circular saw helps to ensure a clean straight line.
3. Each plank for the first row will be cut to the border plank width minus 1/2-in to allow for an expansion gap.

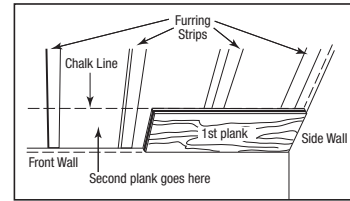

illus. B

head could interfere with installation. **NOTE:** Plank's groove must slide freely with the clip. Tightening the screw too much could cause the clip to twist and keep the planks from floating properly. Ensure the clips are level.

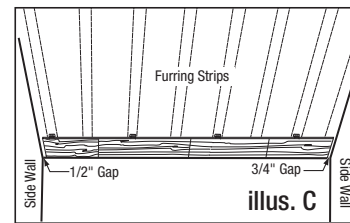

illus. C

Install First Row of Planks

1. Align the groove edge of the border plank with the chalk line. (illus. B)
2. Slide clips into the groove at the furring strips and screw clips to the underside of the furring strip. Ensure screws are installed straight into furring strip. If installed at an angle, the screw
3. Continue measuring, cutting and installing first row of planks. Cut last plank to the length that leaves a 3/4-in gap at the opposite side wall. (illus. C) **NOTE:** 1/2-in and 3/4-in gap are critical for normal expansion and contraction. The gaps will be covered by crown molding.

Instructions if Installing Item 1149 Bead Board:

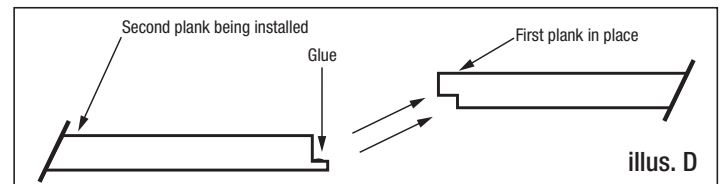

illus. D

Plank ends meet with a shiplap joint. When you install the second plank with the shiplap joint facing up (illus. D) apply a small amount of water-based wood glue to the joint. Any material expansion due to room conditions will take place at the ends of each course of plank.

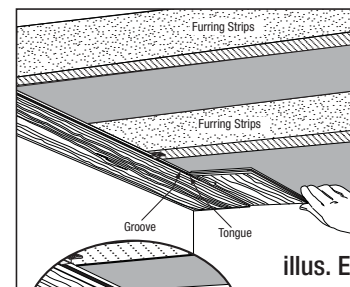

illus. E

Install Remaining Planks

1. Seams from row to row should be staggered. Cut some length from the first plank of the second row to stagger the seams from row to row keeping the 1/2-in and 3/4-in gaps at the ends.
2. Start the second row by inserting the tongue into the groove of the piece in the first row. (illus. E)
3. Measure the distance to the wall, and cut the last row of planks to fit. Cut off the groove side. Insert the tongue of the last row into groove of previous row. Run 1 screw per plank into the plank at the furring strip location. **OPTION:** You can drive three finishing nails per plank into the wall directly under the face of the plank to hold in place. Molding will complete the installation.

Groove Tongue

screw per plank into the plank at the furring strip location. **OPTION:** You can drive three finishing nails per plank into the wall directly under the face of the plank to hold in place. Molding will complete the installation.

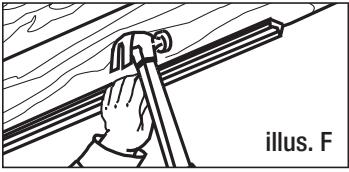

Install Molding

1. Choose molding wide enough to cover the expansion gap and any plank edge.
2. Paint or stain decorative molding before installing.

illus. F

3. Install molding at the joint between the ceiling and walls. Nail to the wall. Do not nail into the WoodHaven™ plank.
4. Nail molding into the wall studs at least every 24-in. (illus. F)

Installing WoodHaven™ Planks on a 15/16-in Suspension System with Easy Up® Clips:

LARGE CEILING REQUIREMENT

Easy Up® Expansion Joint

If your ceiling installation is greater than 21-ft in the length direction of the WoodHaven™ planks, an expansion joint is required. You will need to plan this detail into the ceiling layout. Expansion joints can be placed more frequently than 21-ft to achieve a balanced visual. **A drawing of this detail is shown below.**

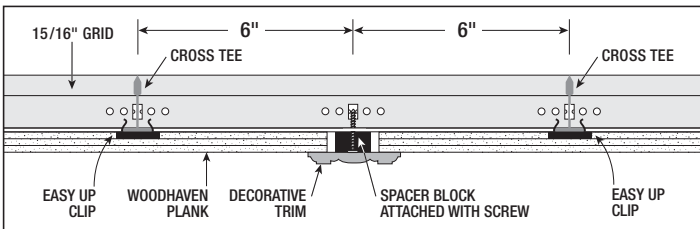

On 15/16-in grid, expansion joints should be located 6-in from a row of grid. An additional row of 2-ft or 4-ft cross tees will need to be added 6-in on the other side of the expansion joint to provide additional support for the WoodHaven planks. Depending on your grid layout and intended direction of the planks, you may need to remove some 2-ft cross tees and add additional 4-ft cross tees to provide the required support (See detail below.) Use a WoodHaven plank to create a spacer for the expansion joint. Rip down the plank into 7/8-in wide and 6-ft long strips. Attach these strips to the face of the grid and wall molding at every intersection with a screw. Countersink the screws so they do not interfere with the installation of the finish molding. **NOTE:** The final step in creating the expansion joint will take place once the ceiling is installed. When installing WoodHaven planks, they should be cut to leave a 1/2-in gap on either side of the expansion joint spacer piece. Each plank should be supported 6-in from the expansion joint with an Easy Up clip attached to grid. After all the WoodHaven ceiling planks are installed, finish off the expansion joint with a 2-1/2-in or wider piece of decorative trim or molding (available from other manufacturers). Pre-painting the decorative trim will help keep your ceiling installation clean. This trim should be attached to the expansion joint assembly and grid using finishing nails or counter sunk screws. Putty and touch up paint as needed.

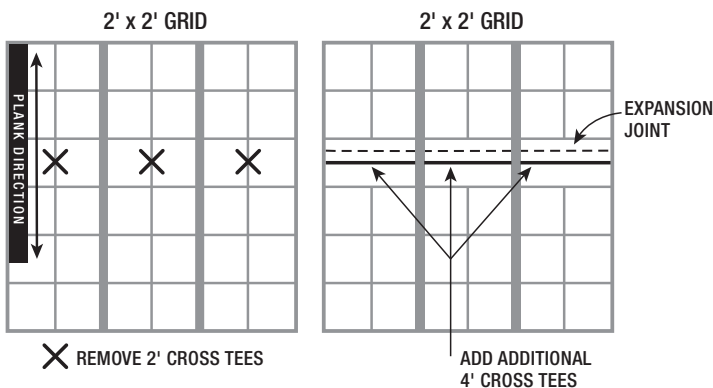

GENERAL INSTALLATION:

- Do not install WoodHaven planks over an existing acoustical tile ceiling. If you are updating an existing 15/16-in suspension system, be sure to remove the ceiling panels prior to installing WoodHaven planks.
- If you need instructions for installing a new Armstrong® Prelude® suspension system, please visit ceilings.com/installation.
- Clips included in the WoodHaven packaging will only be utilized when a plank's leading edge lands on or near a parallel grid piece and an Easy Up clip cannot be installed. See tip below.
- Easy Up® clips are sold separately. Visit ceilings.com to order a sample Easy Up clip to test your grid. Clip should snap on with a snug fit, be able to slide on the grid, and require some force to remove.
- WoodHaven planks must be supported every 24-in.

Determine Plank Direction

- In a typical 2-ft x 4-ft suspended ceiling layout, install planks perpendicular to the cross tees, parallel to the main beams as shown in the image below.
- In a typical 2-ft x 2-ft suspended ceiling layout, you can install planks either perpendicular to or parallel with the cross tees as shown in the image below.

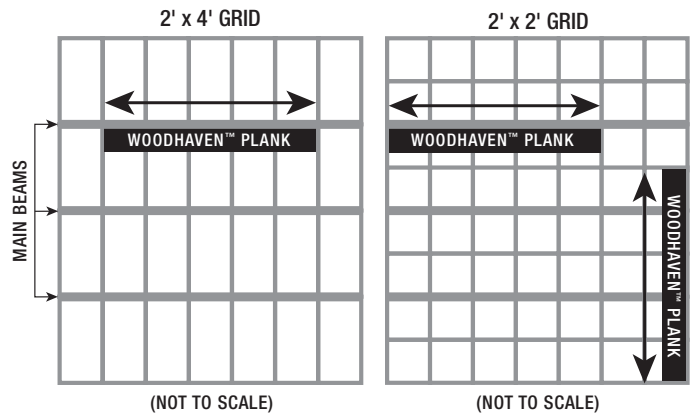

NOTE: A 2-ft x 4-ft system can be converted to a 2-ft x 2-ft system by adding 2-ft cross tees.

Determine Your Layout and Size of Your Border Planks. Measure the length of the room, in the direction of your tracks, and opposite the joists, to determine the size of your border planks.

Example:

Room = 178"

$178" \div 5" = 35.6$

$0.6 \times 5" = 3"$

$3" + 5" = 8"$

$8" \div 2 = 4"$

Border plank width = 4"

Your Room:

1. Total room length

Room = 178"

2. Divide total by 5"

$178" \div 5" = 35.6$

3. Multiply the remainder by 5"

$0.6 \times 5" = 3"$

4. Add 5" to the result

$3" + 5" = 8"$

5. Divide results by 2

$8" \div 2 = 4"$

6. This is your border plank width

Border plank width = 4"

When starting or ending a WoodHaven Plank installation on 15/16-in suspension system, screw the plank directly to the wall molding.

TIP: This should be covered with a molding of your choice.

Installing the First Plank

Cut the "tongue" side off of the length of the plank for your first border plank. Using a table saw or circular saw helps to ensure a clean straight line.

Leave 3/4-in gap along the starting wall. Lift the first plank up into place and insert the Easy Up clips into the groove side of the plank. Attach the non-supported cut edge of each plank with a screw going into the existing wall molding. These screws should be covered with molding at the end of the installation. Molding will add additional support for the plank.

TIP: Another option is to use three finishing nails as a ledge, located directly under the face of the plank, on which you can rest the plank while you slide the clips into place.

Installing the Remaining Planks

Lay out the room with staggered seams. In most installations, you should be able to use the leftover cut plank from one row to start the next row, with very little waste. Do not use planks smaller than 26-in to ensure attachment with two clips.

Continue installing the plank by connecting the tongue and groove on the long side and end of the plank and snapping an Easy Up Clip at every grid intersection. Slide the clip on the grid until it connects with the "Groove" of the plank. The clip should loosely hold the upper edge of the groove on the plank.

TIP: If a plank's leading edge lands on or near a parallel grid piece, the Easy Up clips may not be able to be properly installed. Use the WoodHaven clip provided in the plank packaging and screw the clip directly to the grid.

Continue to build your ceiling. Double check your math for the width of the last plank. Measure the remaining distance to the wall, and cut off the groove edge of the plank to fit the space. Ensure a 3/4-in gap* on finishing wall to allow for expansion.

To install the last plank tip the tongue of the plank into the groove of the receiving plank. Support this plank by either screwing it to the wall molding with a single screw or create a ledge using finishing nails hammered every 24-in into the wall directly below the face.

TIP: Pre-drilling helps.

We recommend finishing the job with crown molding (not sold by Armstrong Ceilings), painted to match other trim in your space. Clean with a slightly damp rag to remove any dust from your install, leaving you with a beautiful new ceiling.

**A 7-ft plank can expand/contract as much as 1/4-in under extreme humidity changes. This gap allows for normal expansion and will be covered by molding. Consistent humidity levels must be maintained after installation.*

Installing WoodHaven™ Planks on Walls

- Certain WoodHaven™ Plank finishes can be used as wainscoting or on a wall. Visit ceilings.com/woodhaven to view available options.
- Open cartons 2-3 days prior to the install and allow material to adjust to the relative humidity in the space where it will be installed. Maintain consistent humidity levels after installation.
- Vertical layouts cannot exceed 84-in (length of one plank.) No joints allowed in this direction.
- Backer material is recommended for vertical installations to smooth out the wall.
- Backer material or furring strips are required for horizontal installations.

Tools Needed:

Hand saw, circular saw (optional), saber saw (optional), measuring tape, chalk line, cordless or hand screwdriver and pencil. When using power tools, be sure to follow the manufacturer's recommendations for their use.

To prevent wet floors from damaging the planks, install a piece of 3/8-in thick spacer material on the wall at the floor so the bottom of the planks can butt against the top of the spacer material.

While the traditional orientation of wainscoting is vertical, the WoodHaven™ planks can be installed on walls either vertically or horizontally.

Installing WoodHaven Planks Vertically on a Wall

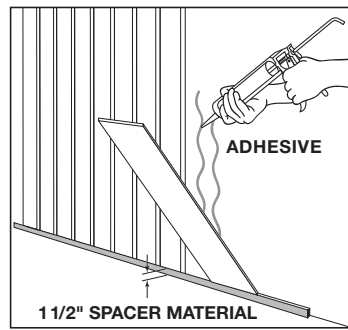

illus. G

When installing the planks vertically, you should use a construction adhesive to secure the planks to the wall or backer material. Be sure to check that the adhesive is suitable for the surface you are adhering to.

Follow the adhesive manufacturer's recommendations for surface preparation and application rate. If the planks do not stick to the wall immediately, use painter's tape to hold the planks to the wall until the adhesive sets up. (illus. G) Finish with a trim of your choice.

Installing WoodHaven Planks Horizontally on a Wall

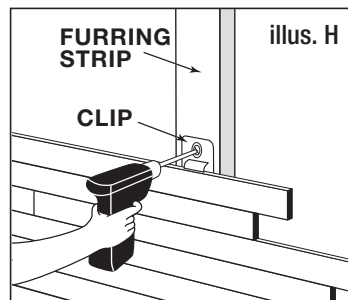

and attach to the backer material or furring strip. Fasten with clips every 24-in. (illus. H)

Finish with a baseboard of your choice covering the spacer material and the bottom of the planks. Trim can be installed at the top of the plank to serve as a chair rail or to finish the installation.

Maintenance Recommendation:

Clean with a damp cloth.

WoodHaven™ Ceiling Plank Ten (10) Year Limited Warranty

For the most up-to-date warranty information, visit ceilings.com/warranty.

For additional information on installing WoodHaven™ Planks, including special installation tips and videos, please visit our website at ceilings.com or call customer service at 1-877-ARMSTRONG (276-7876).

Tell us what you think!

Thank you for your purchase. We hope you're happy with your Armstrong® product and want to hear from you. Please visit ceilings.com/review to write a review.

Armstrong
CEILINGS