

OWNER'S GUIDE

softHEAT

GENTLE FLUID HEAT
FOR THE PEOPLE YOU LOVE MOST



For how-to videos or more information, please visit:
<http://cadetheat.com/install/softheat>

ESPAÑOL ver la guía del propietario en cadetheat.com/espanol/softheat

CADET 
INVITING WARMTH

cadetheat.com
855.CADET.US
Vancouver, Washington



tested to UL standards

IMPORTANT INSTRUCTIONS

⚠ When using electrical appliances, basic precautions should always be followed to reduce the risk of fire, electric shock, and injury to persons, including the following:

1. Read all instructions before installing or using this heater.
2. A heater has hot and arcing or sparking parts inside. Do not use it in areas where gasoline, paint, or flammable vapors or liquids are used or stored.
3. This heater is hot when in use. To avoid burns, do not let bare skin touch hot surfaces. Keep combustible materials, such as furniture, pillows, bedding, papers, clothes, and curtains away from heater.
4. To prevent a possible fire, do not block air intakes or exhaust in any manner. Do not use on soft surfaces, like a bed, where openings may become blocked.
5. Do not insert or allow foreign objects to enter any ventilation or exhaust opening as this may cause an electric shock or fire, or damage the heater.
6. Use this heater only as described in this manual. Any other use not recommended by the manufacturer may cause fire, electric shock, or injury to persons.
7. This heater must be installed in a fixed, permanent location.
8. **CAUTION** – High temperature. Keep electrical cords, drapes, and other furnishings away from heater.
9. Extreme caution is necessary when any heater is used by or near children or invalids and whenever the heater is left operating and unattended.

SAVE THESE INSTRUCTIONS

⚠ KNOW YOUR VOLTAGE! ⚠

If you are uncomfortable working with electricity, running electrical supply wire or installing a circuit breaker, please consult a licensed electrician.

- Make sure the heater is the same voltage as the electrical supply wires you're using. The wire size must be correct for the voltage, the heater wattage and the circuit breaker.

single pole breaker

120 volt

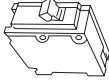

double pole breaker

240 volt



- A 120 volt heater will fail if connected to a 240 volt electrical supply! Connecting a 240 volt heater to a 120 volt electrical supply will only give you one quarter of the heat output.

Unanswered questions? Call our technical support team in Vancouver, Washington at **855.CADET.US (855.223.3887) or 360.693.2505.**

TOOLS REQUIRED

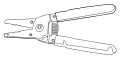

Wire Strippers



Wire Connectors

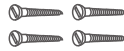

1 1/2" Wood Screws

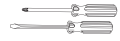

Straight and Phillips Screwdrivers



Stud Finder



Tape Measure



Drill and Drill Bits

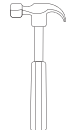

Hammer



Volt Meter

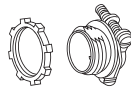

1/2" Cable Clamp Connector



Level

A multi-purpose tool or something to cut your existing base trim or molding

INSTALLATION INSTRUCTIONS

1. All electrical work and materials must comply with the National Electric Code (NEC), the Occupational Safety and Health Act (OSHA), and all state and local codes.
2. Use copper conductors only.
3. Do not install below an electrical receptacle.
4. Do not install the heater against combustible low-density cellulose fiberboard.
5. Heater must be level.
6. **CAUTION** – High temperature. Keep electrical cords, drapes, and other furnishings away from heater.
7. To reduce the risk of fire, do not store or use gasoline or other flammable vapors and liquids in the vicinity of the heater.
8. Maintain at least 12 inches (30.5 cm) minimum clearance from all objects above and in front of baseboard, and 6 inches (15.2 cm) minimum on both sides.

NOTE: All baseboard heaters require a thermostat (sold separately)

PARTS OF YOUR HEATER

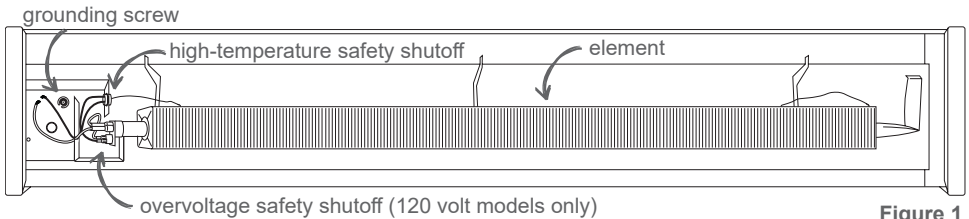
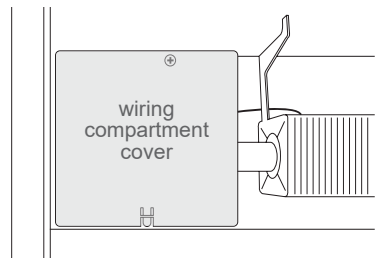
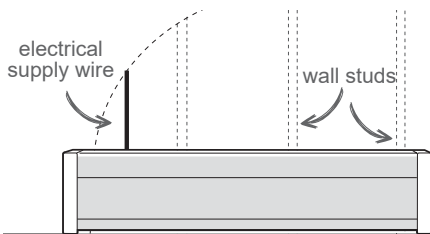

Figure 1

STEP 1 Locate or route electrical supply wires

- For best results, install your SoftHEAT baseboard heater under a window and use an electronic wall thermostat.
- Install only in a horizontal position, not in a vertical position.
- Remove any floor base trim or molding so the heater will set flush against the wall. It can sit directly on any floor surface, including carpet.
- If you're wiring a **WALL** thermostat, route the electrical supply wire from the circuit breaker to the wall thermostat, and then to the baseboard. If you're wiring a **BUILT-IN** model EBKN thermostat, route the electrical supply wire from the circuit breaker directly to the baseboard.
- SoftHEAT baseboards can only be wired on one side. They are available with either a left end wiring compartment, or a right end wiring compartment.



1. Turn off the electrical power supply. Locate wall studs and electrical supply wires. Remove front cover by lifting up from the bottom, and then outward.
2. Unscrew and remove wiring compartment cover.

INSTALLATION INSTRUCTIONS

STEP 2 Wire connection

- **KNOW YOUR VOLTAGE** and **CHECK YOUR BREAKER!**
- All baseboards require three supply wires. For 120 volt baseboard wiring you will have 1 hot, 1 neutral and 1 ground. For 240 volt baseboard wiring you will have 2 hots and 1 ground; no neutral needed.

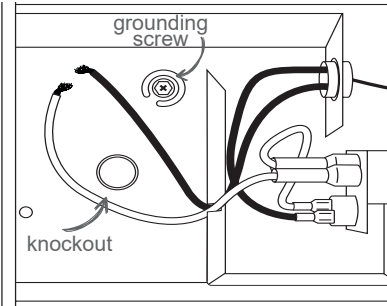

1. Remove one of the knockouts in the wiring compartment. We recommend using the rear knockout. If you use the bottom one, you must protect the wire with electrical tubing and add a conduit connector (not included) at the floor.

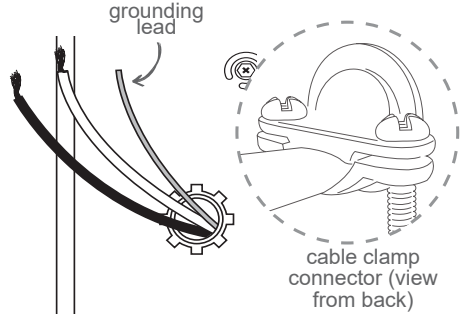

4. Install a cable clamp connector (not included). Pull supply wires through the cable clamp connector leaving 6-inch (15.2 cm) wire leads.

5. Connect the grounding lead to the green grounding screw on the side you're wiring.

If you're wiring a **BUILT-IN** model EBKN thermostat for your heater, go to those instructions now (included with your thermostat) and follow that installation. When complete, proceed to **Mount heater to wall** on page 5.

If you're wiring a **WALL** thermostat for your heater, follow the instructions below. Your electrical supply wires should be routed from the circuit breaker to the wall thermostat, and then to the heater.

120 VOLT CONNECTION

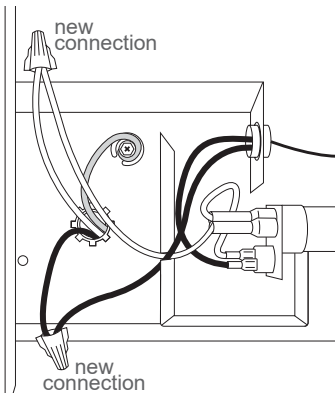

Figure 2

1. Connect one supply wire to one of the heater wires with a wire connector (not included):
 - A. for 240 volts, it doesn't matter which heater wire (Figure 3);
 - B. for 120 volts, connect the neutral (white) supply wire to the white heater wire (Figure 2).

240/208 or 208 VOLT CONNECTION

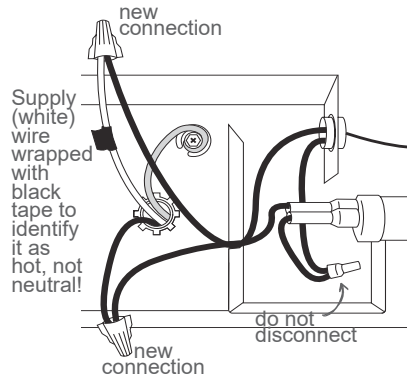

Figure 3

2. Connect the remaining supply wire to the remaining heater wire with a wire connector.
3. Tuck all wires back into the wiring compartment, and make sure the connections are tight.
4. Screw the wiring compartment cover back on.

The volume of the SoftHEAT wiring compartment is 36 cubic inches (589.9 cubic centimeters).

INSTALLATION INSTRUCTIONS

STEP 3 Mount heater to wall

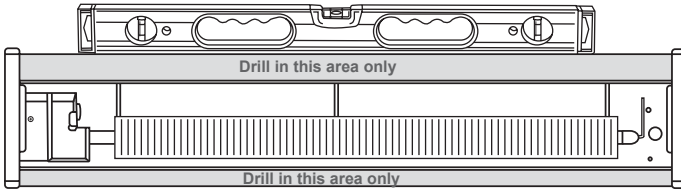

Figure 4

1. Drill holes in shaded areas only and secure to two or three wall studs with wood screws (not included). **IMPORTANT:** make sure your heater is level before tightening screws down all the way.
2. Attach the heater front cover.
3. Turn power back on at the main disconnect panel.

Please verify installation

After installation, operate your SoftHEAT baseboard for **at least 30 minutes** with the thermostat set to its maximum temperature. If your room doesn't get warmer, please contact Cadet directly, as your electrical supply voltage may not match the heater voltage.

toll free: 855.CADET.US (855.223.3887) or 360.693.2505

live chat: cadetheat.com/customer-service

blog: cadetheat.com/120v-softheat

4. Proceed to OPERATING INSTRUCTIONS.

MULTIPLE HEATERS WITH ONE THERMOSTAT (240 or 208 volt only)

More than one heater can be wired in parallel on the same circuit breaker (be sure to check national and local codes for safety requirements). Additional electrical supply wire and cable clamp connectors are required, and you'll need to use a wall thermostat. When wiring multiple heaters to one thermostat, the heaters must be in the same room.

The maximum amperage load you can put on one circuit breaker is limited to either 80% of the circuit breaker capacity, or the maximum amperage rating of the thermostat, **whichever is lower**.

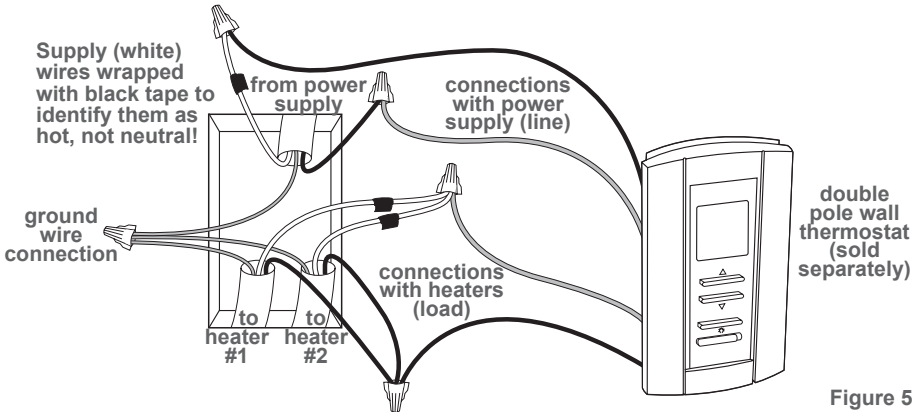

Figure 5

1. A separate set of electrical supply wire must be run from the wall thermostat to each baseboard.
2. All the 3-wire connections must be made in the electrical junction box of the wall thermostat (See Figures 5 and 10)! They cannot be made in either of the wiring compartments of the heaters. An extra deep electrical junction box is recommended so you'll have enough room for all the wires. Tuck all wires back into the junction box and make sure the connections are tight.
3. In the wiring compartment of each heater, connect one supply wire to one of the heater wires with a wire connector (not included), it doesn't matter which one (See Figure 3).
4. Connect the remaining supply wire to the remaining heater wire with a wire connector (not included) (See Figure 3).
5. Tuck all the wires back into the individual wiring compartments, and make sure the connections are tight.
6. Screw the wiring compartment covers back on. Proceed to STEP 3 above.

INSTALLATION INSTRUCTIONS

High-temperature safety shutoffs

All SoftHEAT baseboards come with a built-in high-temperature safety shutoff that stops electricity flowing to the heater if it gets too hot inside. This automatically resets after cooling.

In addition to the standard safety feature, 120 volt SoftHEAT baseboards have a unique built-in feature that stops electricity flowing to your heater if it's connected to the wrong voltage.

INTERNAL HEATER WIRING DIAGRAMS

Single pole thermostat

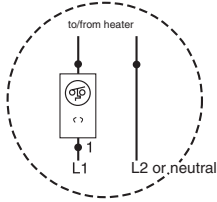

Figure 6

Double pole thermostat

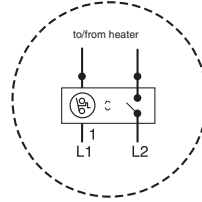
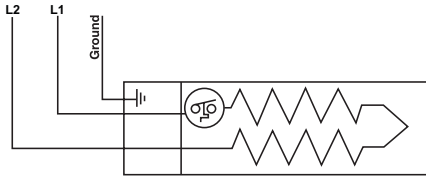
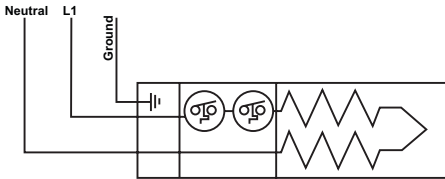

Figure 7



240 or 208 volt models left end wiring

Figure 8



120 volt models left end wiring

Figure 9

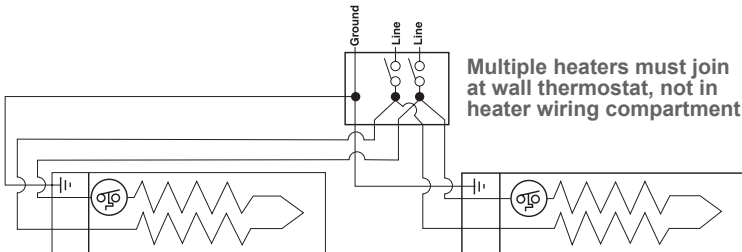

Connecting multiple units 240 or 208 volt models only
Double pole wall thermostat left end wiring

Figure 10

OPERATING INSTRUCTIONS

1. Make sure all wires are properly connected and your heater is installed before you turn it on.
2. Do not tamper with the high-temperature safety shutoff.

How to operate your heater

The room temperature is controlled by a thermostat located either on the wall, or on the heater. Once installation is complete and power has been restored, follow the steps below for your thermostat.

If you have a wall or built-in thermostat with a knob:

1. Turn the thermostat knob all the way to the right.
2. When the room reaches your comfort level, turn the knob to the left, just until it clicks and the heater turns off. The heater will automatically keep the room temperature around this setting.
3. To reduce the room temperature, turn the knob to the left. To increase the room temperature, turn the knob to the right.

If you have an electronic thermostat, follow the instructions in the programming and operating guide included with your thermostat.

What is the fluid inside the element?

The SoftHEAT fluid is a non-toxic mineral oil. No special first aid measures are needed if the fluid is swallowed, inhaled, or if it gets on your skin or in eyes; simply rinse or wash with soap and water.

The fluid does not freeze.

What about cleanup and disposal?

If the fluid leaks, stop using the heater. Cleanup is the same as it is for used oil. Wipe up any leaking fluid with a rag or paper towel. Dispose of fluid at a recycling center that accepts used oil. Wash hands with soap and water.

For more information you can view the Safety Data Sheet here: cadetheat.com/softheat/sds

PLEASE NOTE: On initial start-up, the heater may cause an odor due to the manufacturing process. It typically goes away within several hours.

WARRANTY

For more effective and safer operation and to prolong the life of the heater, read the Owner's Guide and follow the instructions. Failure to properly maintain the heater will void any warranty and may cause the heater to function improperly.

LIMITED SEVEN YEAR WARRANTY: Cadet will repair or replace any Cadet SoftHEAT (EBHN) heater found to be defective within seven years after the date of purchase.

These warranties do not apply:

1. Damage occurs to the product through improper installation or incorrect supply voltage;
2. Damage occurs to the product through improper maintenance, misuse, abuse, accident, or alteration;
3. The use of unauthorized accessories or unauthorized components constitutes an alteration and voids all warranties. Refer to Cadet website or call customer service at 855.CADET.US or 360.693.2505 for list of authorized accessories and components.

4. CADET'S WARRANTY IS LIMITED TO REPAIR OR REPLACEMENT.

5. IN THE EVENT CADET ELECTS TO REPLACE ANY PART OF YOUR CADET PRODUCT, THE REPLACEMENT PARTS ARE SUBJECT TO THE SAME WARRANTIES AS THE PRODUCT. THE INSTALLATION OF REPLACEMENT PARTS DOES NOT MODIFY OR EXTEND THE UNDERLYING WARRANTIES. REPLACEMENT OR REPAIR OF ANY CADET PRODUCT OR PART DOES NOT CREATE ANY NEW WARRANTIES.

If you believe your Cadet product is defective, please contact Cadet during the warranty period, for instructions on how to have the repair or replacement processed.

Parts and Service

Visit cadetheat.com/parts-service for information on where to obtain parts and service.

To register your product, visit cadetheat.com/product-registration



Reduce-Reuse-Recycle

This product is made primarily of recyclable materials. You can reduce your carbon footprint by recycling this product at the end of its useful life. Contact your local recycling support center for further recycling instructions.

MAINTAINING YOUR HEATER

Clean heater at least every 24 months or as required.

1. It is important that you verify power has been turned off and the element is cool.
2. Wipe cover with damp cloth and dry.
3. Use the hose on your vacuum to clean the heater. Do not touch the element.
4. Turn power back on at the main disconnect panel.

Any service other than cleaning should be performed by an authorized service representative.

TROUBLESHOOTING

Symptom	Problem	Solution
Heater doesn't get hot.	<ol style="list-style-type: none"> 1. Circuit breaker is 120 volts and heater is 240 volts. 2. Multiple baseboards wired in series. 	<ol style="list-style-type: none"> 1. Double check the voltage of the heater to make sure it matches the voltage of the circuit. Replace heater with a model that is 120 volts. 2. Wire baseboards in parallel (see MULTIPLE HEATERS WITH ONE THERMOSTAT on page 5).
Heater doesn't work at all.	<ol style="list-style-type: none"> 1. Circuit breaker is faulty. 2. Supply connections are loose. 	<ol style="list-style-type: none"> 1. Call a licensed electrician. 2. Turn off power at main disconnect panel. Inspect and/or tighten all the wire connectors inside the heater and at any connection points inside junction boxes or at the wall thermostat.
Heater is making noise.	<ol style="list-style-type: none"> 1. Heater makes creaking or popping noises. 2. Humming noise. 	<ol style="list-style-type: none"> 1. The heating element expands slightly when turned on. This is normal. 2. Baseboard cabinet may need slight adjustment. Call Cadet technical support team at 855.CADET.US (855.223.3887) or 360.693.2505.
Heater smells after installation or not being used.	<ol style="list-style-type: none"> 1. Odor from element manufacturing process. 2. Supply connections are loose. 3. Dust or lint inside the heater. 	<ol style="list-style-type: none"> 1. On initial start-up, the heater may cause an odor due to the manufacturing process. It typically goes away within several hours. 2. Turn off power at main disconnect panel. Inspect and/or tighten all the wire connectors inside the heater and at any connection points inside wiring compartments or at the wall thermostat. 3. Clean heater (see "MAINTAINING YOUR HEATER" above for instructions).
Heats briefly then stops.	<ol style="list-style-type: none"> 1. Overvoltage safety shutoff has tripped on initial startup or first use (120 volt models only). 2. High-temperature safety shutoff has tripped. 	<ol style="list-style-type: none"> 1. Heater is 120 volts and connected to 240 volts. Replace heater with a model that is 240 volts. Call Cadet at 855.CADET.US (855.223.3887) or 360.693.2505 for assistance. 2. Remove all obstructions. Do not block heater. Maintain 12 inches (30.5 cm) above and front. Keep heater free of lint and dust.
Heater doesn't turn off.	<ol style="list-style-type: none"> 1. Thermostat is defective. 2. No thermostat hooked up to control heater. 3. Incorrect heater wattage for room size. 	<ol style="list-style-type: none"> 1. Replace thermostat. 2. A thermostat is required for all heaters. Purchase a built-in or wall thermostat for your heater. 3. Install higher wattage model or additional heaters if circuit allows.
Breaker trips immediately after installing heater.	<ol style="list-style-type: none"> 1. A short circuit exists in the electrical supply wires or heater wiring. 2. Circuit is overloaded. 3. Circuit breaker is faulty. 	<ol style="list-style-type: none"> 1. An incorrect connection in the heater or electrical supply wires may cause sparking or arcing. Inspect all heater and electrical supply wiring insulation for damage or call an electrician. 2. Use a lower wattage heater, or reduce the number of heaters on the circuit. 3. Call a licensed electrician.
Liquid found in or around heater.	<ol style="list-style-type: none"> 1. Heat transfer fluid dripping from element. 	<ol style="list-style-type: none"> 1. Discontinue use. Replace the element or the heater (elements are not repairable).

If you are uncomfortable working with electricity, running electrical supply wire or installing a circuit breaker, please consult a licensed electrician.

More frequently asked questions on our website here: cadetheat.com/support/FAQ