

Single-Pole Installation

Incandescent/Halogen Dimmer with IR Receiver
MIR-600 (600 W) 120 V~ 60 Hz

Infrared Wireless Transmitter with One-Touch Button
MIR-ITFS

Important Notes

Please read before installing.

- Caution:** To avoid overheating and possible damage to other equipment, do not use to control receptacles, fluorescent lighting fixtures, motor-operated or transformer-supplied appliances.
- Install in accordance with all national and local electrical codes.
- When no "grounding means" exist within the wallbox then the NEC® 2002, Article 404-9 allows a dimmer without a grounding connection to be installed as a replacement, as long as a plastic, noncombustible wallplate is used. For this type of installation, cap or remove the green ground wire on the dimmer and use an appropriate wallplate such as Lutron's *Claro*® series wallplates.
- Do not paint Dimmers.
- Do not use where total lamp wattage is less than 60 W or greater than 600 W (see Dimmer Capacity Chart for details).
- Dimmer may not work with dioded lamps (Sylvania Designer 16™ or Philips PAR-16™).
- Operate between 0 °C (32 °F) and 40 °C (104 °F).
- Dimmer may feel warm to the touch during normal operation.
- Recommended wallbox depth is 2 1/2" (64 mm) minimum.
- Clean dimmer with a *soft damp cloth only*. Do not use any chemical cleaners.

Multigang Installations

When installing more than one control in the same wallbox, it may be necessary to remove all inner side sections prior to wiring (see below). Using pliers, bend side sections up and down until they break off. Repeat for each side section to be removed. Removal of Dimmer side sections reduces maximum load capacity. Refer to the Dimmer Capacity Chart below.

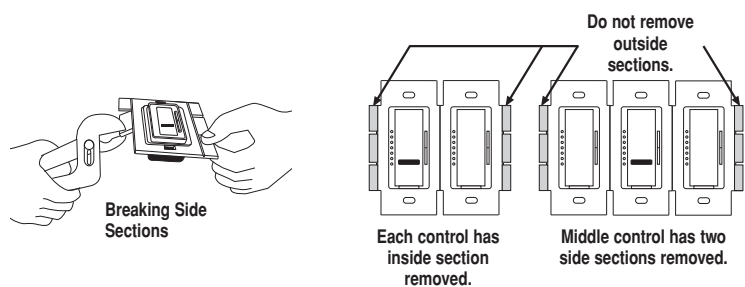

Dimmer Capacity Chart

Model	Load		
	No Sides Removed	One Side Removed	Two Sides Removed
MIR-600	600 W Max	500 W Max	400 W Max

Technical Assistance

If you have questions concerning the installation or operation of this product, call the **Lutron Technical Support Center**. Please provide exact model number when calling.

U.S.A. and Canada (24 hrs/7days)
+1-800-523-9466

Fax +1-610-282-3090

Other countries 8am – 8pm ET
+1-610-282-3800

http://www.lutron.com

Limited Warranty

Lutron will, at its option, repair or replace any unit that is defective in materials or manufacture within one year after purchase. For warranty service, return unit to place of purchase or mail to Lutron at 7200 Suter Rd., Coopersburg, PA 18036-1299, postage pre-paid.
THIS WARRANTY IS IN LIEU OF ALL OTHER EXPRESS WARRANTIES, AND THE IMPLIED WARRANTY OF MERCHANTABILITY IS LIMITED TO ONE YEAR FROM PURCHASE. THIS WARRANTY DOES NOT COVER THE COST OF INSTALLATION, REMOVAL OR REINSTALLATION, OR DAMAGE RESULTING FROM MISUSE, ABUSE, OR DAMAGE FROM IMPROPER WIRING OR INSTALLATION. THIS WARRANTY DOES NOT COVER INCIDENTAL OR CONSEQUENTIAL DAMAGES. LUTRON'S LIABILITY ON ANY CLAIM FOR DAMAGES ARISING OUT OF OR IN CONNECTION WITH THE MANUFACTURE, SALE, INSTALLATION, DELIVERY, OR USE OF THE UNIT SHALL NEVER EXCEED THE PURCHASE PRICE OF THE UNIT.
This warranty gives you specific legal rights, and you may have other rights which vary from state to state. Some states do not allow the exclusion or limitation of incidental or consequential damages, or limitation on how long an implied warranty may last, so the above limitations may not apply to you.
This product is covered under one or more of the following U.S. patents: 4,835,343; 5,017,837; 5,248,919; 5,399,940; 5,637,930; 5,909,087; 6,169,377; 6,300,727; 6,380,696; D496,003 and corresponding foreign patents. U.S. and foreign patents pending. Lutron, Claro, Maestro, and Maestro IR are registered trademarks and FASS is a trademark of Lutron Electronics Co., Inc. NEC is a registered trademark of the National Fire Protection Association, Quincy, Massachusetts.
© 2005 Lutron Electronics Co., Inc.

Installation

1 Turning Off Power.

- Turn power OFF at circuit breaker (or remove fuse).

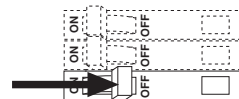

2 Removing Wallplate and Switch.

- Remove the wallplate and switch mounting screws.
- Carefully remove switch from wall (**do not remove wires**).

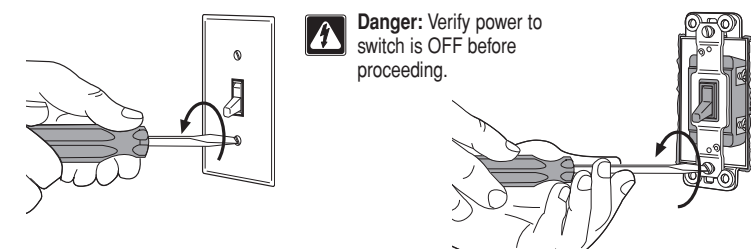

3 Disconnecting Switch Wires.

Important Note: Your wall switch may have two wires attached to the same screw (see illustrations below for examples). Tape these two wires together before disconnecting.

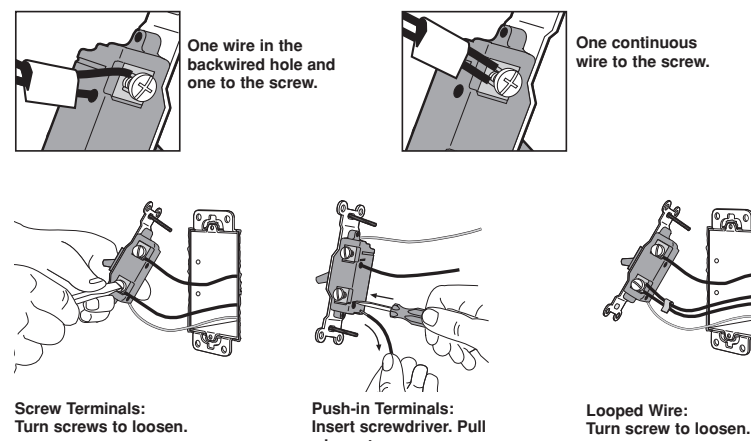

4 Removing Wallplate.

- Dimmer has a pre-installed Lutron *Claro* wallplate. Remove the wallplate before proceeding with installation. This will expose mounting holes in adapter, and prevent wallplate damage while installing.

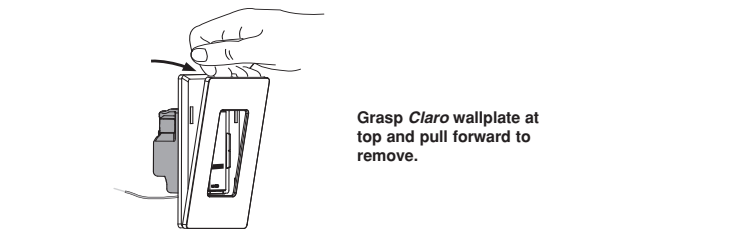

Important Wiring Information

When making wire connections, follow the recommended strip lengths and combinations for the supplied wire connector. **Note:** All wire connectors provided are suitable for **copper wire only**. For aluminum wire, consult an electrician.

Wire Connector: Use to join 14 AWG or 12 AWG ground wire to 18 AWG dimmer ground wire.

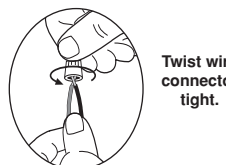

Trim or strip wallbox wires to the length indicated by the strip gauge on the back of the dimmer

Push-in Terminals: Insert wires fully. **NOTE:** Push-in terminals are for use with 14 AWG *solid copper wire only*. DO NOT use stranded or twisted wire.



OR

Screw Terminals: Tighten securely. Screw terminals are for use with 12 or 14 AWG *solid copper wire only*. DO NOT use stranded or twisted wire.

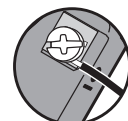

5 Wiring.

- For installations involving more than one control in a wallbox, refer to Multigang Installations before beginning.

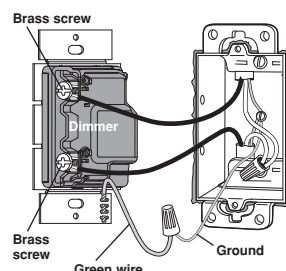

Wiring the Dimmer:

- Using the wire connector provided, connect the **green** ground wire on the Dimmer to the **bare copper** or **green** ground wire in the wallbox. Do not connect it to any other wire. (See Important Note 3.)
- Connect either of the wires removed from the switch to one of the **brass** screw terminals on the Dimmer, or insert fully into the push-in terminal. If your switch had two wires attached to the same screw terminal, connect both wires to the Dimmer terminal.
- Connect the remaining wire removed from the switch to the other **brass** screw terminal on the Dimmer, or insert fully into the push-in terminal.

Reference Wiring Diagram

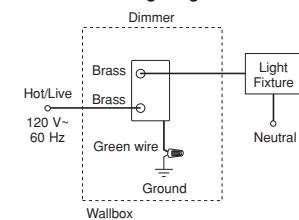

6 Mounting Dimmer to Wallbox.

- Form wires carefully into the wallbox, mount and align Dimmer.
- Replace *Claro* wallplate.



7 Turning On Power.

- Turn power ON at circuit breaker (or replace fuse).

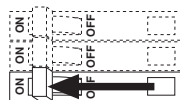

Dimmer Operation

- Tap Button Options**
- Tap once when unit is off** - Lights brighten smoothly to preset intensity.
 - Tap once when unit is on** - Lights dim smoothly to off.
 - Tap twice quickly** - Lights brighten rapidly to full intensity.
 - Press and hold when unit is on** - Each time dimmer is turned off delayed fade to OFF can be activated. As the tap button is held, the LEDs will begin to flash. The first flashing LED represents a 10 second fade to OFF. Each additional flashing LED represents an additional 10 seconds of delay before lights fade to OFF (up to 60 seconds of delay).

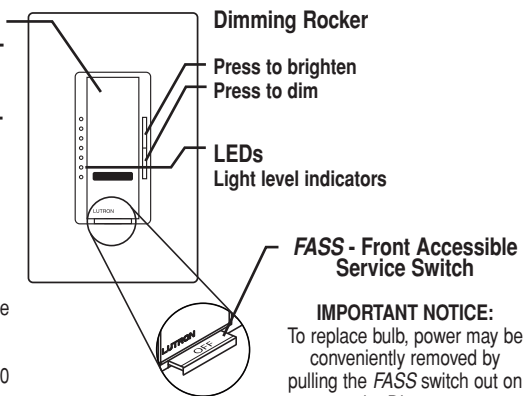

IMPORTANT NOTICE: To replace bulb, power may be conveniently removed by pulling the FASS switch out on the Dimmer. **For any procedure other than routine bulb replacement, power must be disconnected at the main electrical panel.**

To learn about the **Advanced Features** of *Maestro* Dimmers including locked preset and adjustable fade times, please visit: <http://www.lutron.com/maestro/advfeatures> or call the **Lutron Technical Support Center** at +1-800-523-9466

Infrared Wireless Transmitter Operation

Point the transmitter at the *Maestro IR* Dimmer(s), then use the buttons as outlined below.

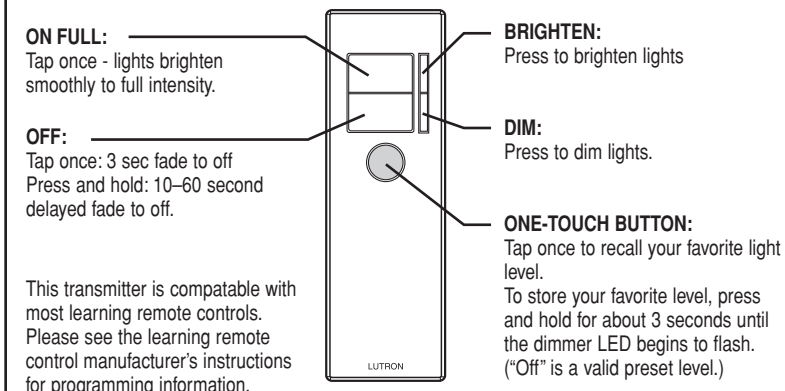

This transmitter is compatible with most learning remote controls. Please see the learning remote control manufacturer's instructions for programming information.

Multiple Gang Application

If multiple *Maestro IR* Dimmers are installed in the same location they will perform as below:

- Pressing the ON FULL button will cause each dimmer to fade to full brightness, regardless of whether some are on and some are off.
- Pressing the OFF button will cause all dimmers to fade off.
- Pressing the BRIGHTEN or DIM buttons will change the light level on all units at the same rate until the button is released or the lights are at min or max level. If any units are off when the BRIGHTEN button is pressed they will turn on at the min brightness level.
- To save your favorite light level, adjust all the dimmers to the desired level then press and hold the ONE-TOUCH button for about 3 seconds until the dimmer LED begins to flash. Once your favorite light level is set, pressing the ONE-TOUCH button will cause each dimmer to return to your favorite light level.

- Easy-to-follow Instructions
- Directives Faciles à Suivre



- 030-862-03 a
- Easy-to-follow Instructions
 - Directives Faciles à Suivre

Troubleshooting

Symptom	Possible Cause
Light does not turn ON or no LEDs turn ON.	<ul style="list-style-type: none"> • Front Accessible Service Switch (FASS™) on Dimmer is pulled out to the OFF position. • Light bulb(s) burned out. • Breaker is OFF or tripped. • Wiring error. Call Lutron Technical Support Center at +1-800-523-9466.
Light does not respond to infrared wireless transmitter.	<ul style="list-style-type: none"> • Transmitter batteries installed incorrectly. • Transmitter batteries are dead. • Transmitter not aimed directly at Dimmer. • Transmitter outside operating range. • Dimmer has already received and responded to command.

Battery Replacement

The Infrared Wireless Transmitter uses 2 AAA batteries that are pre-installed. For best results use alkaline batteries. Do not use NiCad or NiMH batteries.

To replace batteries:

- Remove the battery cover (see diagram).
- Replace with 2 size AAA batteries as shown. **Note:** Incorrect installation will cause batteries to drain.
- Replace the battery cover.

