

Installation Support • Soporte de instalaci n • Support d'installation

Personal Assistance, Product Specs, & "How-to" Questions:

Asistencia personal, especificaciones del producto y preguntas sobre "c mo hacerlo":

Aide personnelle, sp cifications du produit et questions « pratico-pratiques » :

1-800-PFAUCET (732-8238)

pfisterfaucets.com/support

Installation Videos Available
Videos de instalaci n a disposici n
Vid es d'installation disponibles



pfisterfaucets.com/videos



WARNING / AVERTENCIA / AVERTISSEMENT

To reduce the risk of injury or property damage, read all instructions before installing product. Wear safety goggles. Product must be installed in accordance with all state & local plumbing & building codes. Call a professional if you are uncertain about installing this product.

Para disminuir el riesgo de lesiones o da os a la propiedad, lea todas las instrucciones antes de instalar el producto. Utilice gafas de seguridad. El producto deber  instalarse de acuerdo con la normativa de plomer a y construcci n estatal y local. Llame a un profesional si no est  seguro sobre c mo instalar este producto.

Pour r duire le risque de blessures ou de dommages, lire toutes les instructions avant d'installer le produit. Porter des lunettes de s curit . Le produit doit  tre install  en conformit  avec tous les codes de construction et de plomberie locaux et de l' tat. Appelez un professionnel si vous n' tes pas certain de la fa on d'installer ce produit.

Required Tools

Herramientas necesarias

Outils n cessaires



Plumber's Putty
Masilla para plomer a
Mastic de plombier

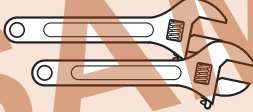

Adjustable Wrenches
Llaves ajustables
Cl s   mollette



Safety Goggles
Anteojos de seguridad
Lunettes de s ret 

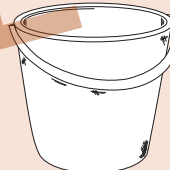

Bucket
Balde
Seau

Additional Helpful Tools

Otras herramientas  tiles

Outils suppl mentaires utiles

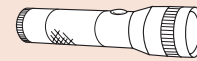

Flashlight
Linterna
Lampe De Poche



Cloth
Pa o de limpieza
Chiffon

Parts in the Box • Piezas en la caja • Pi ces dans la bo te

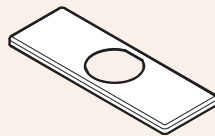

A

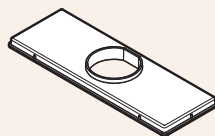

B



C

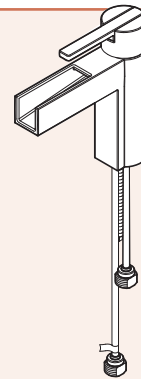

D

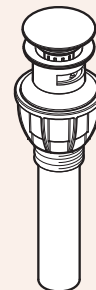

E

1 Turn Off Water Supply • Cierre el suministro de agua • Couper l'alimentation en eau

Locate water supply inlets and shut off the water supply valves. These are usually found under the sink or near the water meter. If you are replacing an existing faucet, remove the old faucet from the sink and clean the sink surface thoroughly.

Ubique las entradas del suministro de agua y cierre las v lvulas de suministro de agua. Generalmente se encuentran debajo del fregadero o cerca del medidor de agua. Si se trata de un reemplazo de grifo, quite el grifo viejo y limpie completamente la superficie del fregadero.

Recherchez les entr es d'approvisionnement et fermer leurs robinets. Ces robinets se trouvent g n ralement sous l' vier ou pr s du compteur d'eau. Si vous remplacez un robinet existant, retirez, le vieux robinet de l' vier et nettoyer soigneusement la surface de ce dernier.

Hot
Caliente
Chaud

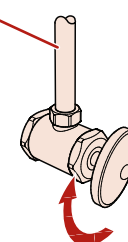

Cold
Fr a
Froid

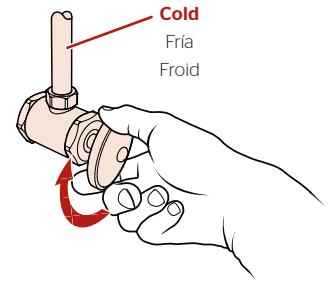

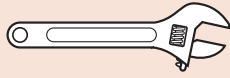
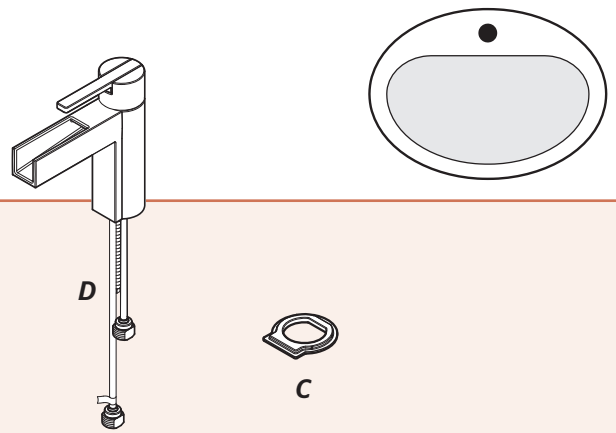
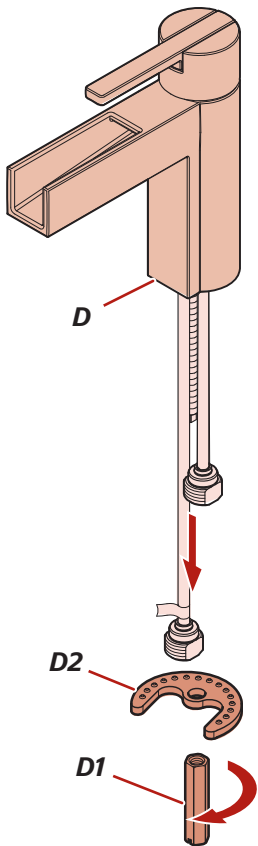
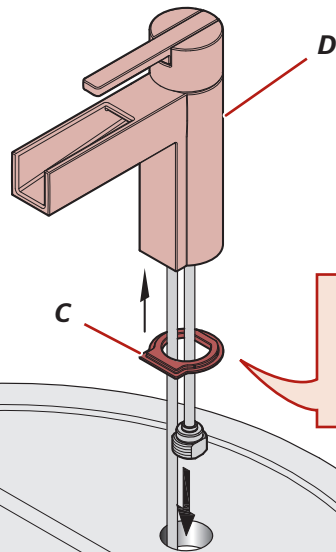
2**OPTION 1: Install Faucet without Deckplate****OPCIÓN 1: Instale el grifo sin la placa de cubierta****OPTION 1: Installer le robinet sans le plate-forme**Plumber's Putty
Masilla para plomería
Mastic de plombierAdjustable Wrench
Llave ajustable
Clé réglable**2A****Disassemble**
Desensamble
Démontez**2B****Apply Plumber's Putty in the groove along the bottom outer edge of Plate (C).**

Aplique masilla de plomería en la ranura a lo largo del borde exterior de la placa inferior (C).

Appliquez du mastic de plombier dans la rainure sur le bord extérieur de la plaque (C).

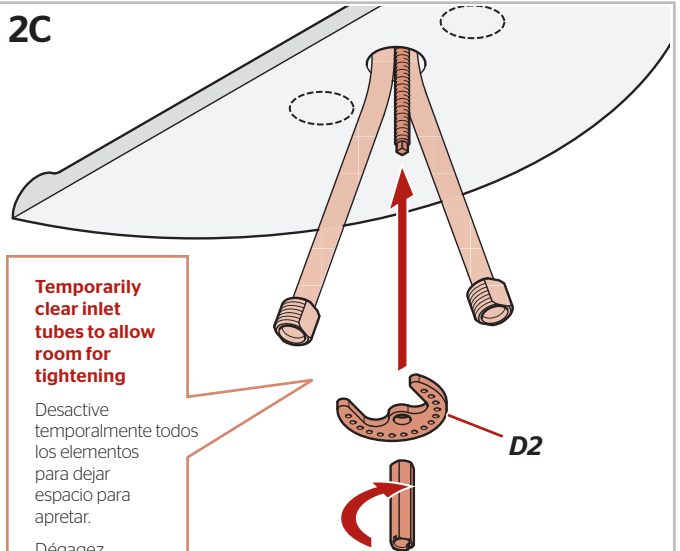
2C**Temporarily clear inlet tubes to allow room for tightening**

Desactive temporalmente todos los elementos para dejar espacio para apretar.

Dégagez les tuyaux temporairement pour permettre le serrage.

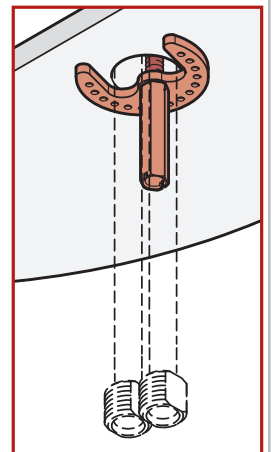
**Make sure that the bumps on the metal washer (D2) are facing up. Be sure the spout body (D) is centered & facing forward. IMPORTANT: DO NOT OVERTIGHTEN.**Cerciórese que las protuberancias de la arandela metálica (D2) estén orientadas hacia arriba. Cerciórese que la estructura del surtidor (D) esté centrada y orientada hacia adelante. **IMPORTANT: NO APIRIETE EXCESIVAMENTE.**Assurez-vous que les bosses de la rondelle en métal sont dirigées vers le haut. Assurez-vous que le corps du bec (D) est centré et tourné vers l'avant. **IMPORTANT: NE PAS TROP SERRER.**

3 OPTION 2: Install Faucet **with Deckplate** OPCIÓN 2: Instale el grifo con la placa de cubierta OPTION 2 : Installer le robinet avec le plate-forme



Plumber's Putty
 Masilla para plomería
 Mastic de plombier

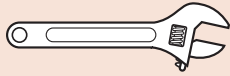

Adjustable Wrench
 Llave ajustable
 Clé réglable

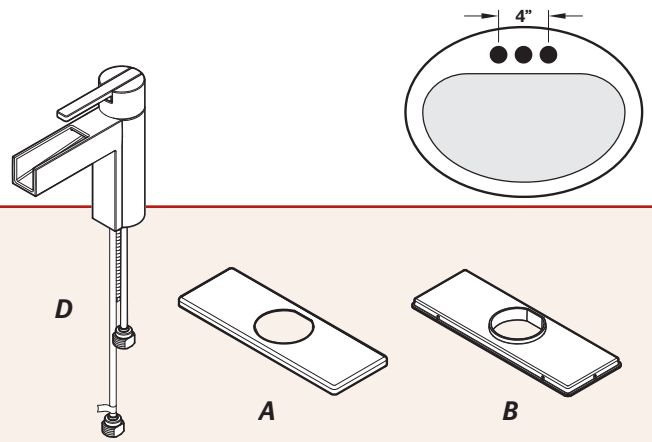

3A Disassemble Desensamble Démontez

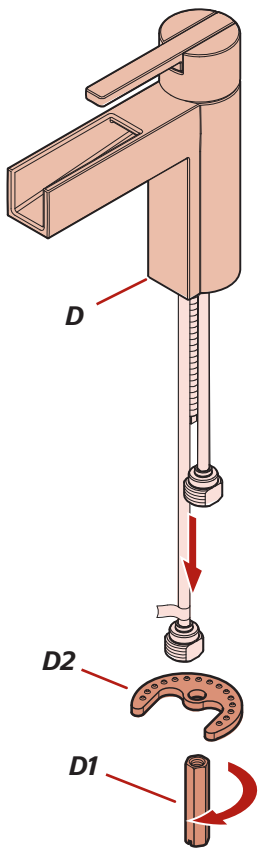

3B

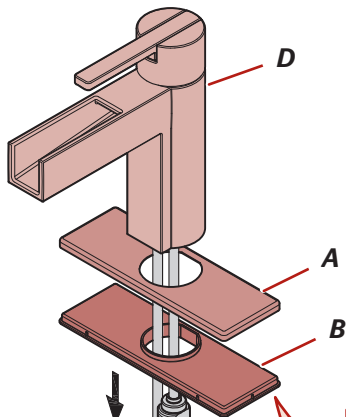

Apply Plumber's Putty in the groove along the bottom outer edge of Plate (B).

Aplique masilla de plomería en la ranura a lo largo del borde exterior de la placa inferior (B).

Appliquez du mastic de plombier dans la rainure sur le bord extérieur de la plaque (B).

3C

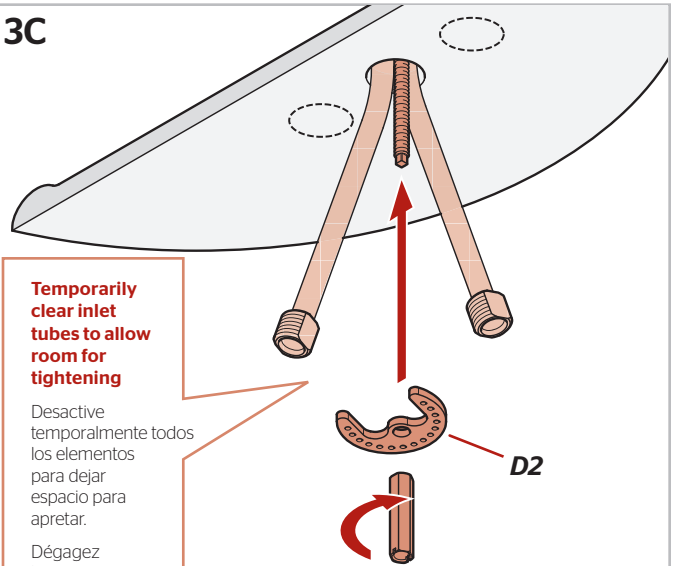

Temporarily clear inlet tubes to allow room for tightening

Desactive temporairement todos los elementos para dejar espacio para apretar.

Dégagez les tuyaux temporairement pour permettre le serrage.



Make sure that the bumps on the metal washer (D2) are facing up. Be sure the spout body (D) is centered & facing forward. IMPORTANT: DO NOT OVERTIGHTEN.

Cerciórese que las protuberancias de la arandela metálica (D2) estén orientadas hacia arriba. Cerciórese que la estructura del surtidor (E) esté centrada y orientada hacia adelante. **IMPORTANTE: NO APRIETE EXCESIVAMENTE.**

Assurez-vous que les bosses de la rondelle en métal sont (D2) dirigées vers le haut. Assurez-vous que le corps du bec (Dest centré et tourné vers l'avant. **IMPORTANT: NE PAS TROP SERRER.**

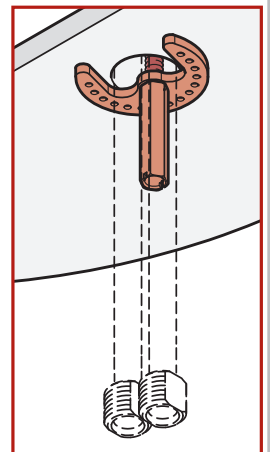

4 Connect Water Supply Lines Conecte las tuberías de suministro de agua Raccorder les conduites d'alimentation en eau

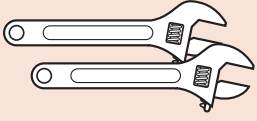

Adjustable Wrenches
Llaves ajustables
Clés à mollette

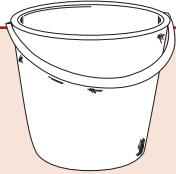

Bucket
Balde
Seau

No Parts Required for This Step
No se necesitan piezas para este paso
Aucune pièce nécessaire pour cette étape

Water Supply Lines not included. Please consult manufacturer and/or its instructions for the correct method of installation of supply lines & fittings.

IMPORTANT: Incorrect application of supply lines and fittings may result in the failure or leak of the supply lines and fitting.

Las tuberías de suministro de agua no están incluidas. Consulte por favor el fabricante y/o sus instrucciones para el método correcto de instalación de líneas de suministro y de guarniciones.

IMPORTANT: El uso incorrecto de líneas de suministro y de guarniciones puede dar lugar a la falta o al escape de las líneas de suministro y de la guarnición.

Les tuyaux d'arrivée d'eau ne sont pas fournis. Veuillez consulter le fabricant et/ou ses instructions pour la méthode correcte d'installation des conduites d'alimentation en eau et des accessoires.

IMPORTANT: Mauvaise application des lignes d'alimentation et accessoires peut entraîner la défaillance ou la fuite.

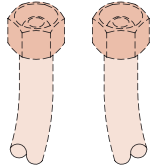

HOT
CALIENTE
CHAUD

COLD
FRÍA
FROID

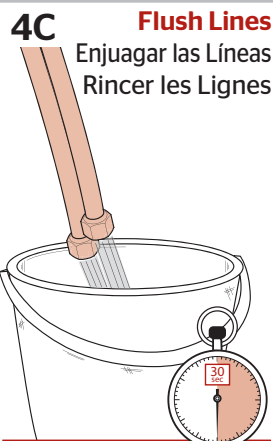
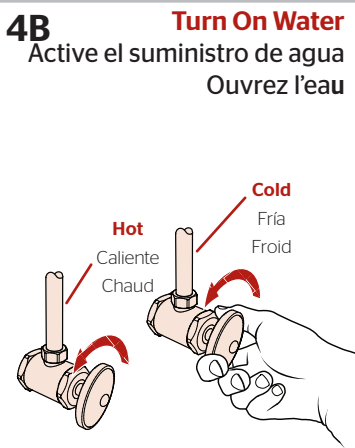
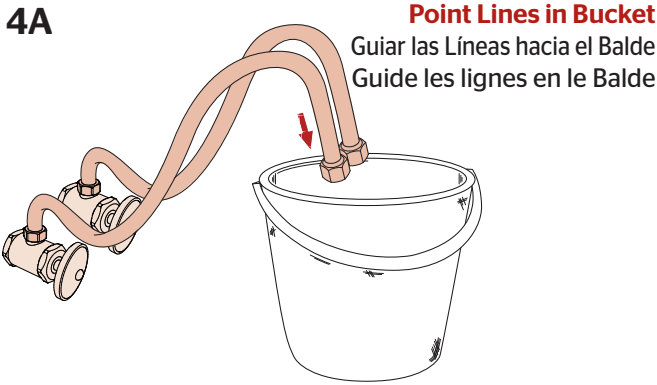

Allow water to run for at least 30 seconds.

Deje correr el agua durante al menos 15 segundos.

Permettez à l'eau couler au moins 15 secondes.

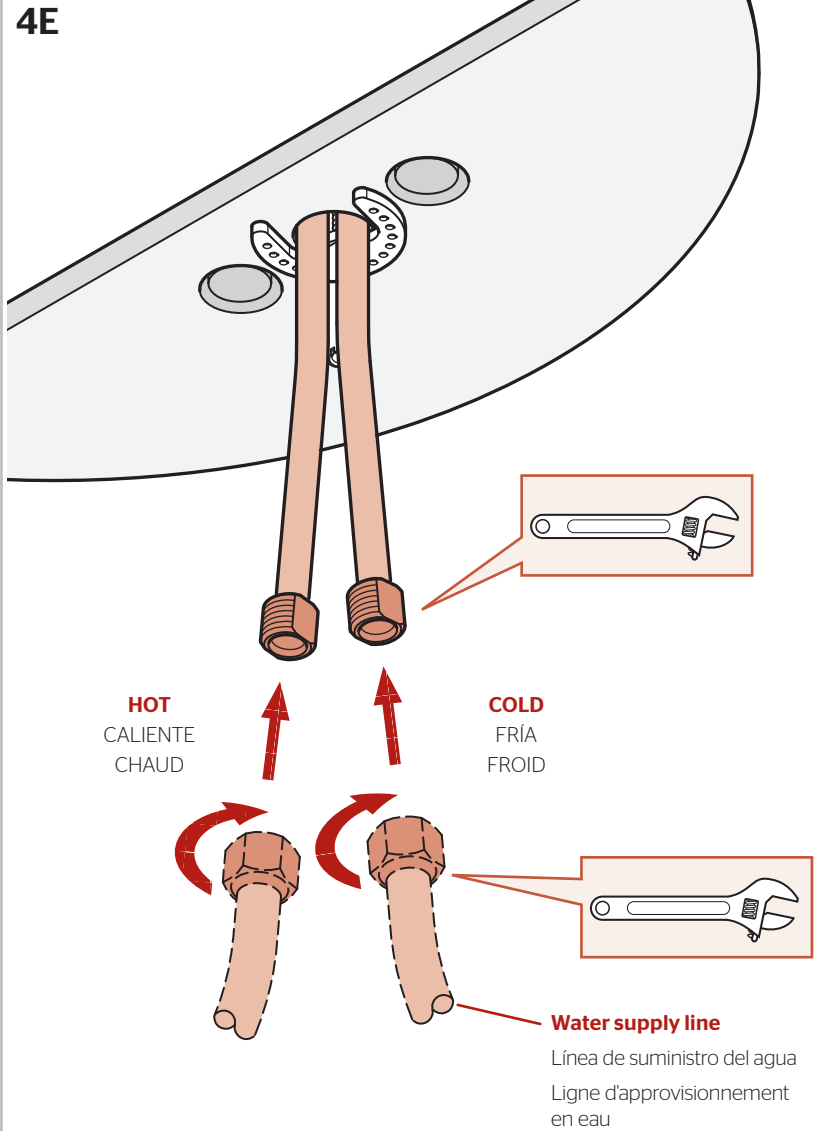
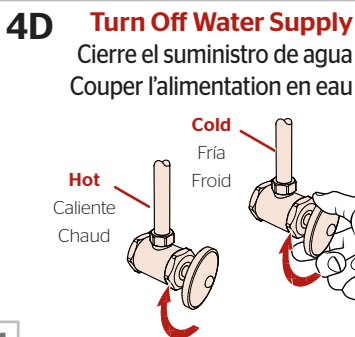

5

Prepare & Install Push & Seal™ Drain

Prepare y instale cuerpo de drenaje Push & Seal™

Préparez & installez le corps de drainage Push & Seal™

No Tools Required for This Step
No se necesitan herramientas para este paso
Pas d'outil nécessaire pour cette étape

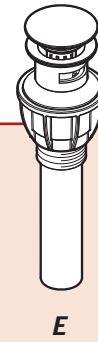

5A Disassemble Pop-Up Desensamble el cuerpo de drenaje Démontez le corps de drainage

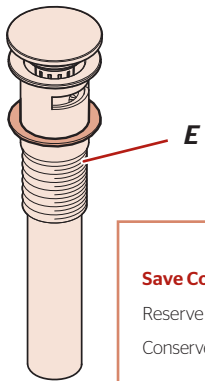

Save Components.

Reserve los componentes.
Conservez les composants.

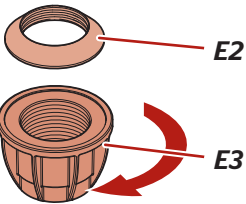

5B



Align logo to sink

Alinee la insignia con el fregadero
Alignez le logo sur l'évier

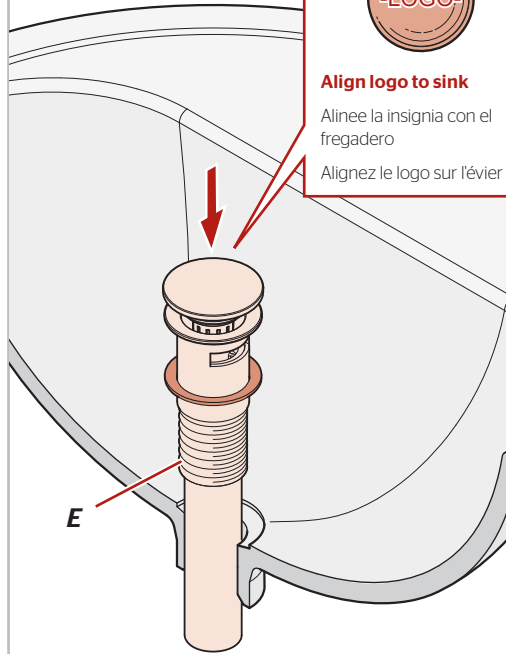

5C

Partially thread drain body to sink.

Rosque parcialmente el cuerpo de drenaje en el fregadero.

Filetez partiellement le corps de drainage dans l'évier.

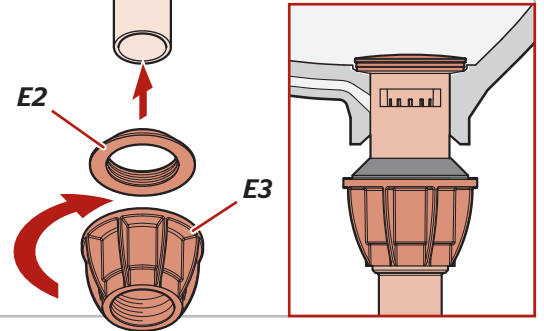

5D

Connect to Drain

Conexión al desagüe
Branchez au drainage

Drain
Desagüe
Drainage

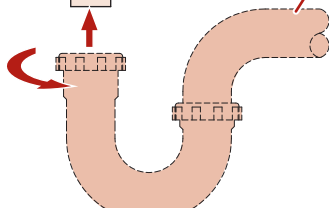

5E

PUSH TO ACTIVATE
EMPUJE PARA ACTIVAR
POUSSEZ POUR ACTIVER

Firmly thread drain body into sink.

Rosque firmemente el cuerpo de drenaje.
Filetez fermement le corps de drainage.

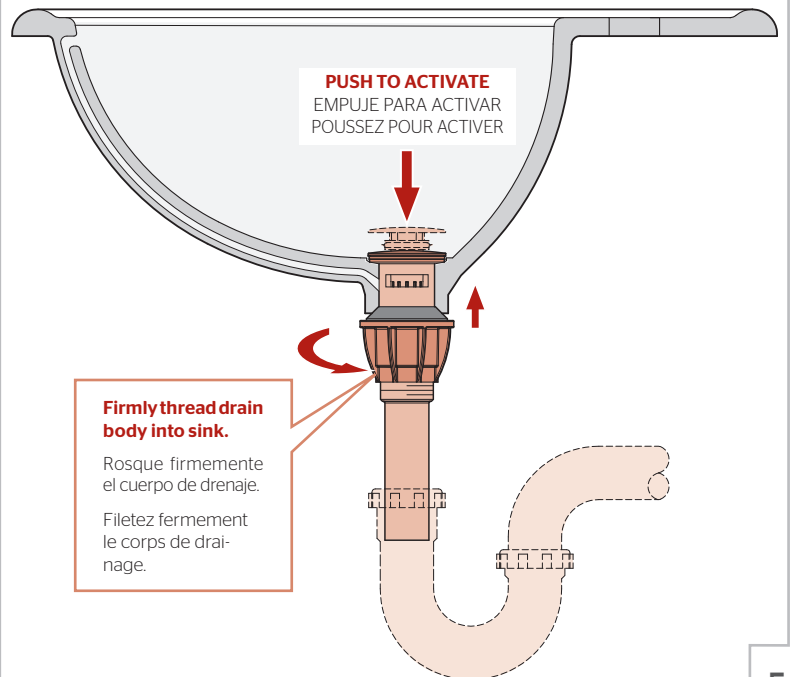

6 Turn On Water & Confirm Proper Installation

Active el suministro de agua y confirme que la instalación está adecuadamente efectuada
Ouvrez l'eau et confirmez que l'installation est correcte

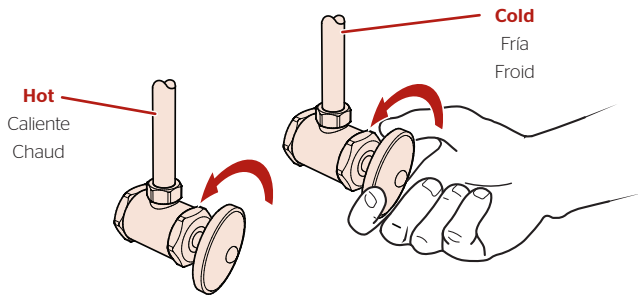

Check for leaks above and below the sink.

Revise si hay fugas encima y debajo del fregadero

Assurez-vous qu'il n'y a pas de fuite au dessus ou au dessous du lavabo.

7 Faucet Function

Funciones del grifo

Fonctionnement du robinet

Open
Abierta
Ouvverte

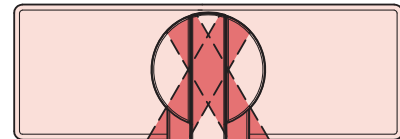
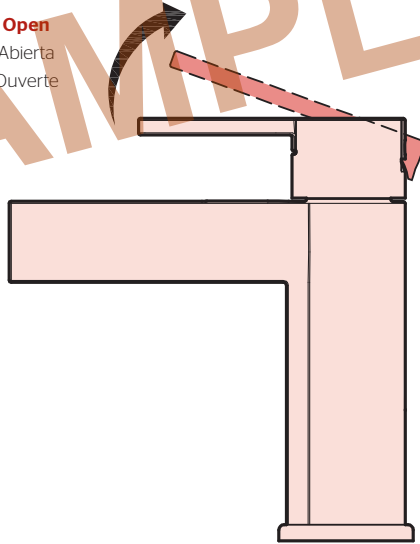

Hot
Caliente
Chaud

Cold
Fría
Froid

For Additional Installation Help:
Para la instalación adicionales de ayuda:
Pour les aides supplémentaires à l'installation:

Pfister

1-800-PFAUCET (732-8238)
pfisterfaucets.com