



Installation Support • Soporte de instalación • Support d'installation

Personal Assistance, Product Specs, & "How-to" Questions:

Asistencia personal, especificaciones del producto y preguntas sobre "cómo hacerlo":

Aide personnelle, spécifications du produit et questions « pratique-pratiques » :

1-800-PFAUCET (732-8238)

pfisterfaucets.com/support

Installation Videos Available
Videos de instalación a disposición
Vidéos d'installation disponibles



pfisterfaucets.com/videos



WARNING / ADVERTENCIA / AVERTISSEMENT

To reduce the risk of injury or property damage, read all instructions before installing product. Wear safety goggles. Product must be installed in accordance with all state & local plumbing & building codes. This product may take two people to install. Call a professional if you are uncertain about installing this product.

Para disminuir el riesgo de lesiones o daños a la propiedad, lea todas las instrucciones antes de instalar el producto. Utilice gafas de seguridad. El producto deberá instalarse de acuerdo con la normativa de plomería y construcción estatal y local. Este producto se puede tomar a dos personas para instalar. Llame a un profesional si no está seguro sobre cómo instalar este producto.

Pour réduire le risque de blessures ou de dommages, lire toutes les instructions avant d'installer le produit. Porter des lunettes de sécurité. Le produit doit être installé en conformité avec tous les codes de construction et de plomberie locaux et de l'état. Ce produit peut prendre deux personnes pour installer. Appelez un professionnel si vous n'êtes pas certain de la façon d'installer ce produit.

Required Tools

Herramientas necesarias
Outils nécessaires

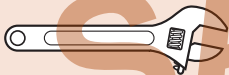

Adjustable Wrench
Llave ajustable
Clé à Mollette



Safety Goggles
Anteojos de seguridad
Lunettes de sûreté

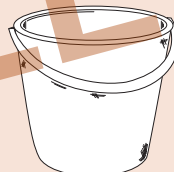

Bucket
Balde
Seau

Additional Helpful Tools

Otras herramientas útiles
Outils supplémentaires utiles

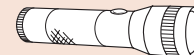

Flashlight
Linterna
Lampe-torche



Cloth
Paño de limpieza
Chiffon

Parts in the Box

Piezas en la caja
Pièces dans la boîte

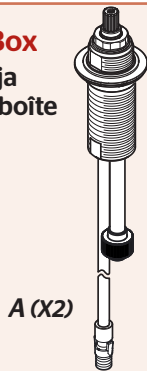

A (x2)



B (x2)



D (x2)



C (x2)



E

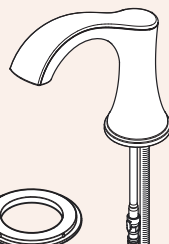

F

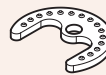

G



H



J (x2)



K



L



Supplied Install Tool
Instalar la herramienta
Outil d'installation fourni



Aerator Tool
Herramienta aireador
Outil d'aérateur

1 Turn Off Water Supply • Cierre el suministro de agua • Couper l'alimentation en eau



Locate water supply inlets and shut off the water supply valves. These are usually found under the sink or near the water meter. If you are replacing an existing faucet, remove the old faucet from the sink and clean the sink surface thoroughly.

Ubique las entradas del suministro de agua y cierre las válvulas de suministro de agua. Generalmente se encuentran debajo del fregadero o cerca del medidor de agua. Si se trata de un reemplazo de grifo, quite el grifo viejo y limpie completamente la superficie del fregadero.

Recherchez les entrées d'approvisionnement et fermer leurs robinets. Ces robinets se trouvent généralement sous l'évier ou près du compteur d'eau. Si vous remplacez un robinet existant, retirez, le vieux robinet et nettoyer soigneusement la surface de l'évier.

Hot
Caliente
Chaud

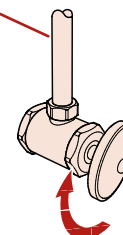

Cold
Fría
Froid

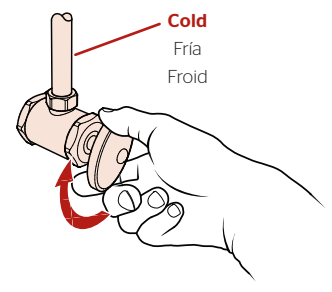

2

Valve Installation Instalación de las válvulas Montage des valves

No Tools Required for This Step
No se necesitan herramientas para este paso
Pas d'outil nécessaire pour cette étape

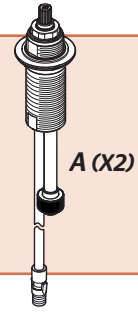

2A

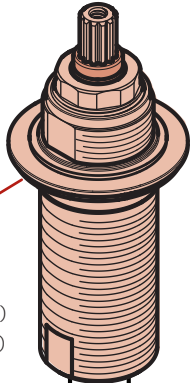

HOT (RED)
CALIENTE (ROJO)
CHAUD (ROUGE)

The HOT valve, with Red Ring should be positioned to the left side of the spout.

La válvula del agua CALIENTE, con el anillo rojo, debe colocarse a la izquierda del surtidor.

La valve d'eau CHAUDE, avec l'anneau rouge, doit être placée sur le côté gauche du bec.

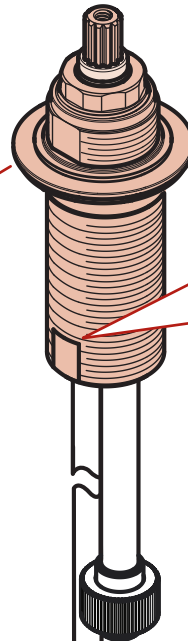

COLD (BLUE)
FRÍA (AZUL)
FROID (BLEUE)

x2
Location of flats may vary.

Localización de el plano puede ser diferente.
Localisation de la fente peut être différent

2B

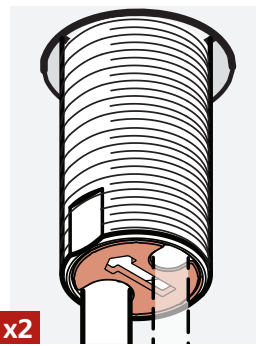

! **x2**
Position valve arrow to face sink, this ensures handle will be aligned.

Posicione la flecha para enfrentar el fregadero, esto asegura manivela estará alineada.

Positionnez la flèche pour faire face à l'évier ce qui assure poignée est aligné.

3 Secure Valve Bodies & Install Handles

Asegurar el cuerpo de la válvula y instale las manijas

Fixez les corps de valve et Installez les poignées

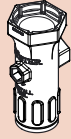

Supplied Install Tool
Instalar la herramienta
Outil d'installation fourni



B (X2)



C (X2)



D (X2)

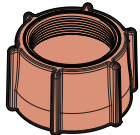
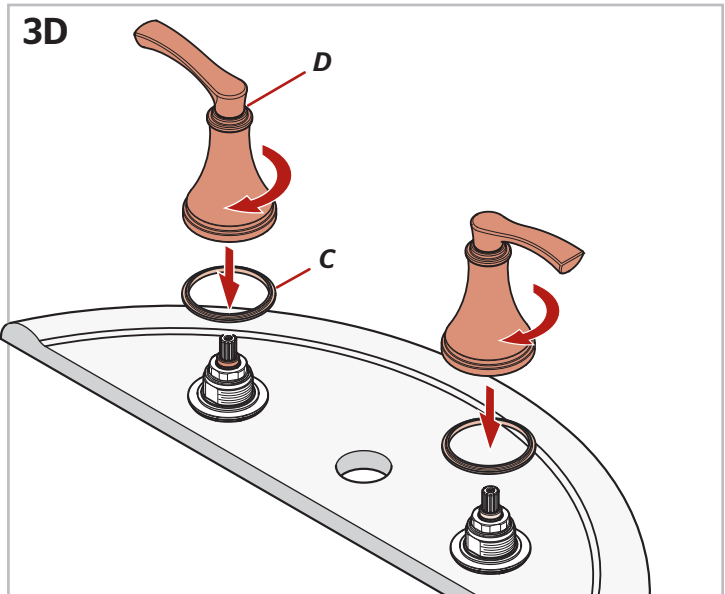
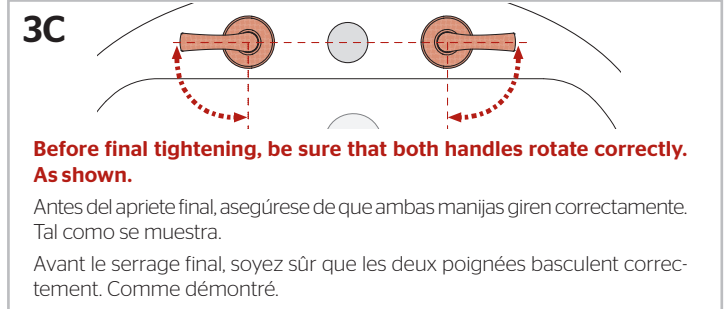
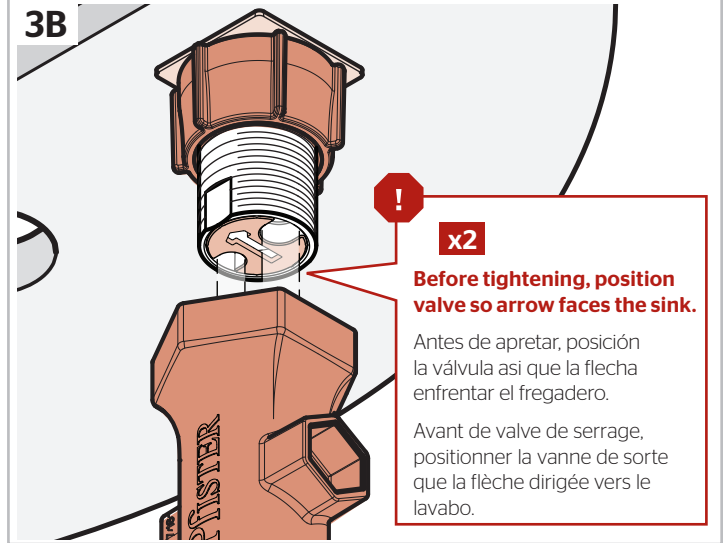
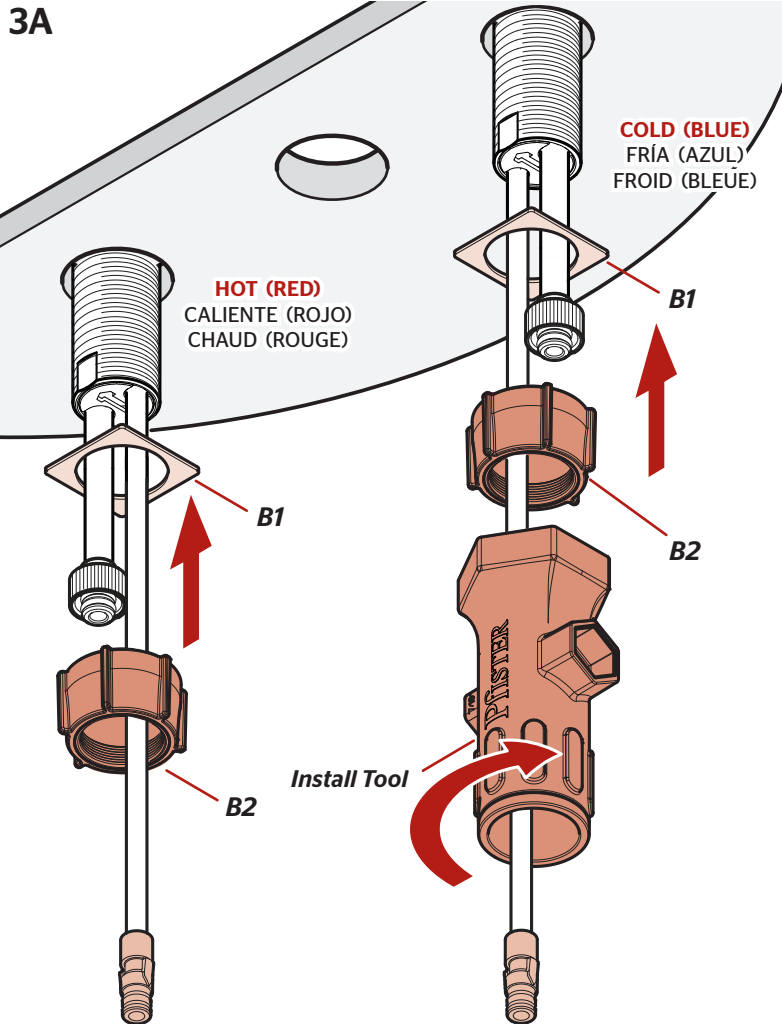

Use nut with threads up for decks up to 2" thick.

Utilice la tuerca con rosca para cubiertas de hasta 51mm de espesor.

Utiliser l'écrou avec filetage pour les ponts jusqu'à 51mm d'épaisseur.

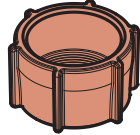

Use nut with threads down for decks up to 1-1/2" thick.

Utilice la tuerca con rosca hacia abajo para cubiertas de hasta 38mm de espesor.

Utiliser l'écrou avec des fils vers le bas pour les terrasses jusqu'à 38mm d'épaisseur.

If deck is thicker than 2", order Valve Extension Kit 900-058 / 900-059.

Si la plataforma es más gruesa de 51mm, pida la pieza de repuesto 900-058 / 900-059.
Si le pont est plus épais que 51mm, commandez le kit d'extension 900-058 / 900-059.

4 Install Spout Instale el surtidor Installez le bec



Supplied Install Tool
Instalar la herramienta
Outil d'installation fourni

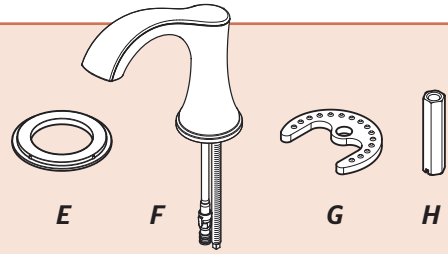

4A

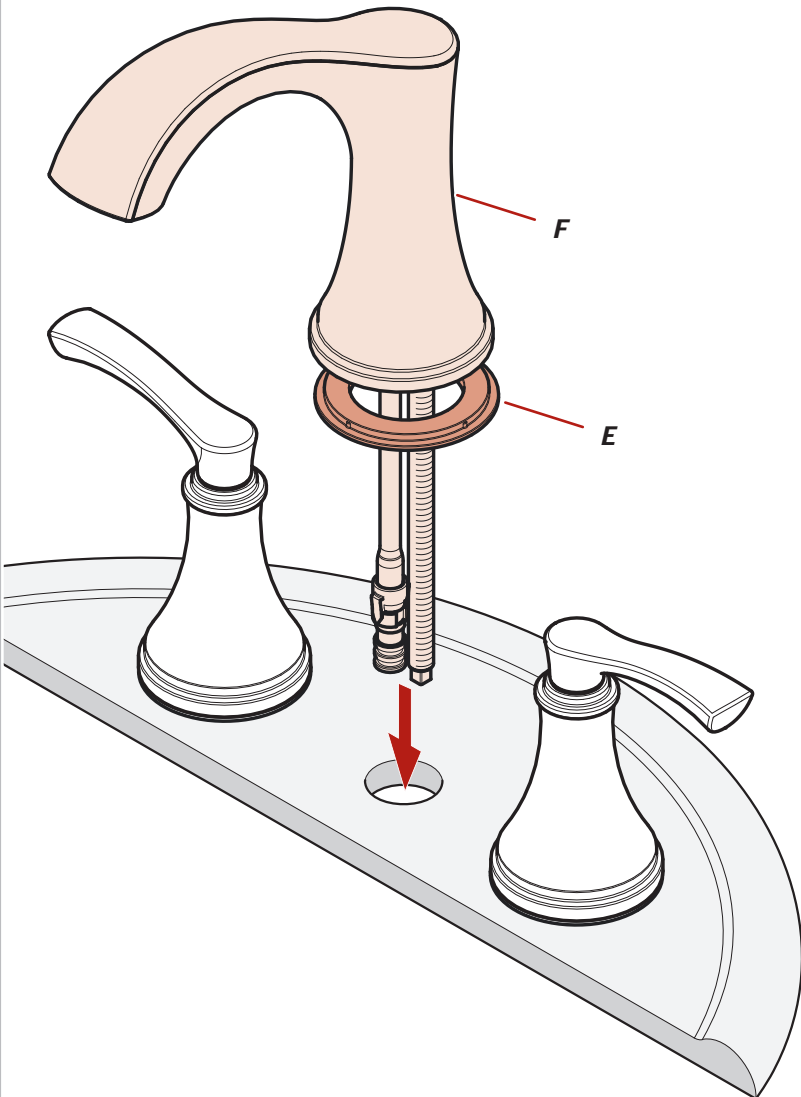

4C

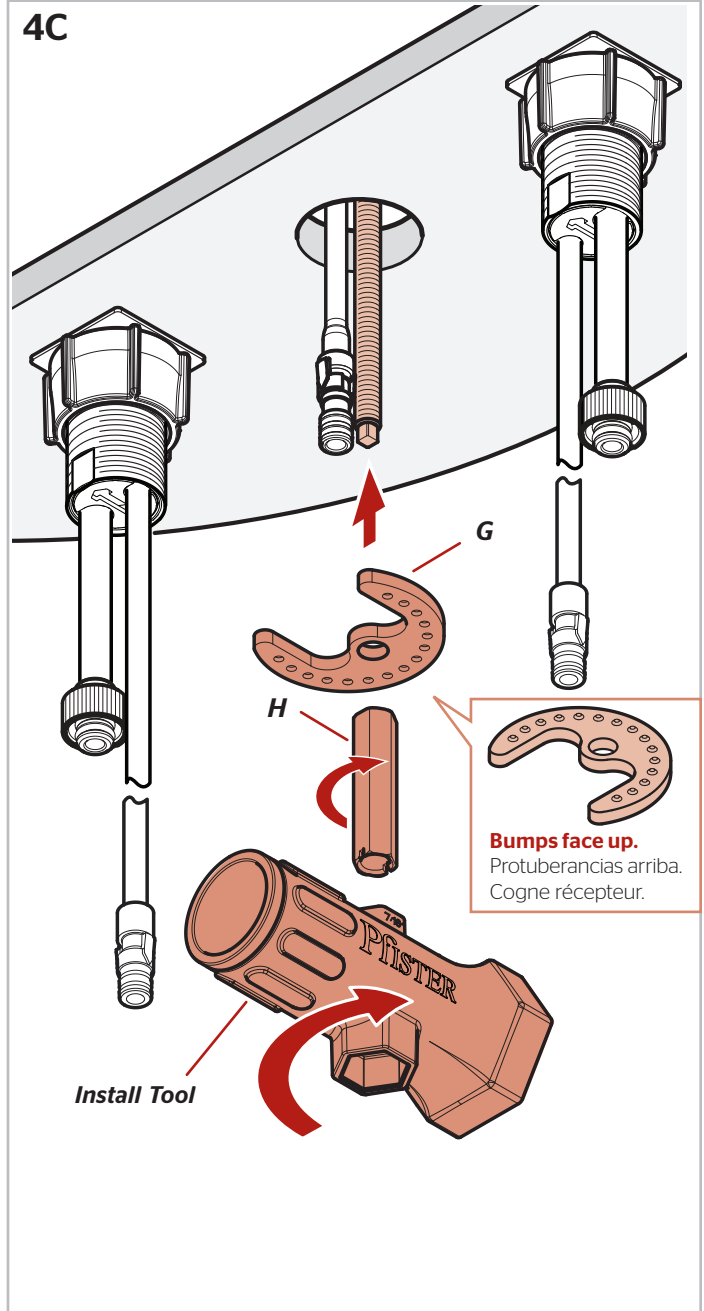

5

Hose Connections

Conecciones de la manguera

Connexions des tuyaux

No Tools Required for This Step
 No se necesitan herramientas para este paso
 Pas d'outil nécessaire pour cette étape



K

5A

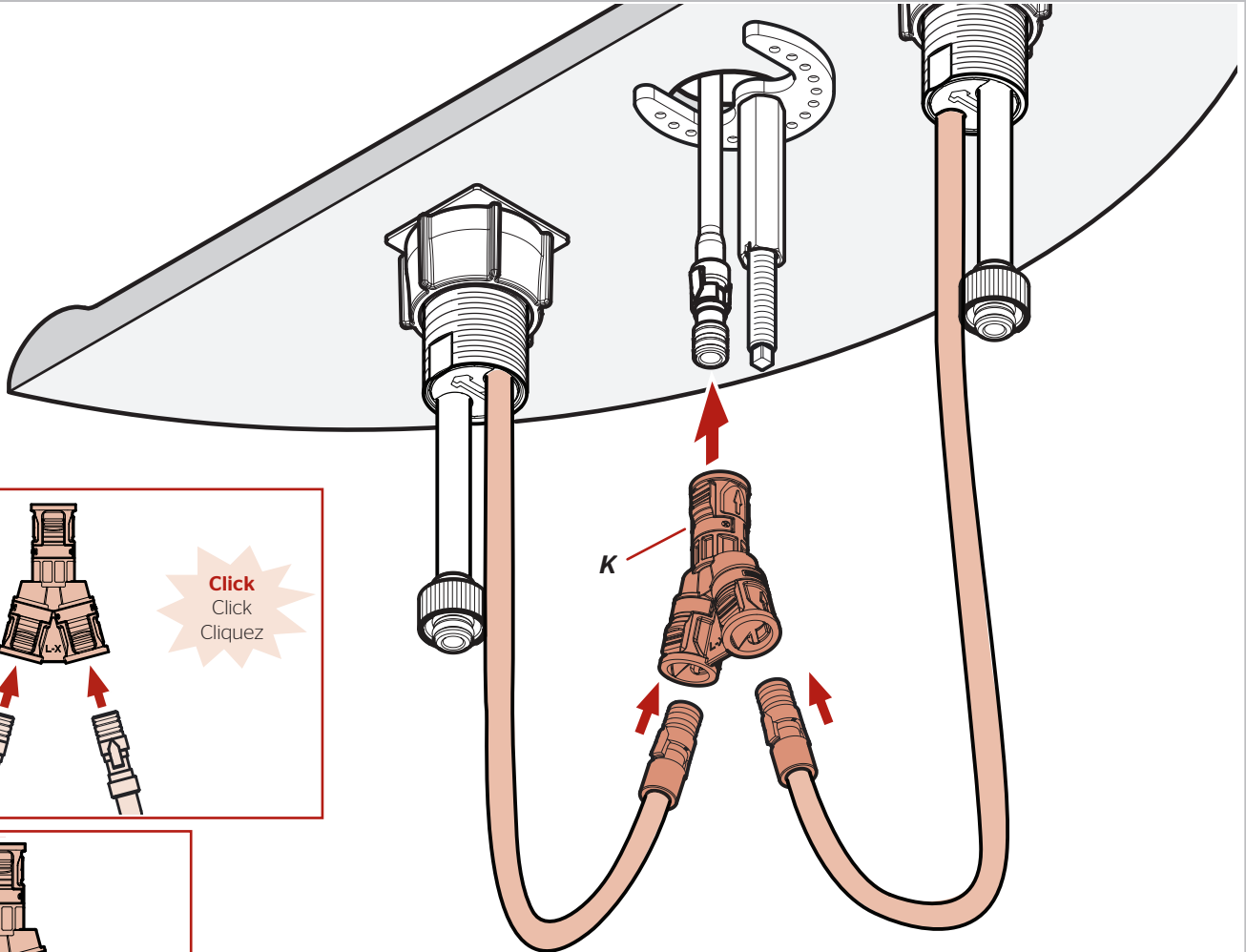

5B

Click
Click
Cliquez

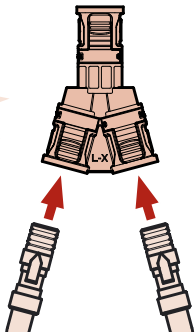

Click
Click
Cliquez

5C

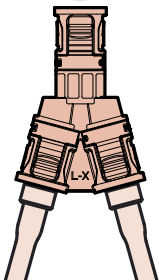

Check that connections are secure by pulling down on the tubes while avoiding buttons. They should not come off the spout connector.

Compruebe que las conexiones estén aseguradas tirando abajo de los tubos evitando botones. No deben salir de la conexión del surtidor.

Vérifiez que les connexions sont sécurisées en tirant vers le bas les tubes en évitant les leviers. Ils ne doivent pas laisser la connexion bec.

5D

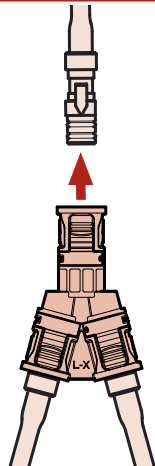

5E

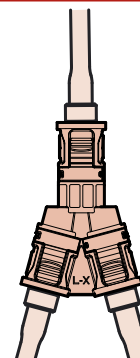

Check that the connection is secure by pulling down on the spout connector.

Compruebe que la conexión es segura tirando hacia abajo el conector de boquilla.

Assurez-vous que la connexion est sécurisée en tirant le connecteur de la buse.

6 Connect Water Supply Lines

Conecte las tuberías de suministro de agua

Raccorder les conduites d'alimentation en eau

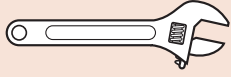

Adjustable Wrench
Llave ajustable
Clé à Mollette



Supplied Install Tool
Instalar la herramienta
Outil d'installation fourni

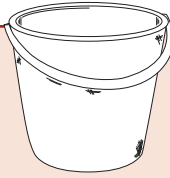

Bucket
Balde
Seau

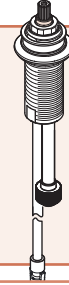

A



J(x2)

Water Supply Lines not included. Please consult manufacturer and/or its instructions for the correct method of installation of supply lines & fittings.

IMPORTANT: Incorrect application of supply lines and fittings may result in the failure or leak of the supply lines and fitting.

Las tuberías de suministro de agua no están incluidas. Consulte por favor el fabricante y/o sus instrucciones para el método correcto de instalación de líneas de suministro y de guarniciones.

IMPORTANT: El uso incorrecto de líneas de suministro y de guarniciones puede dar lugar a la falta o al escape de las líneas de suministro y de la guarnición.

Les tuyaux d'arrivée d'eau ne sont pas fournis. Veuillez consulter le fabricant et/ou ses instructions pour la méthode correcte d'installation des conduites d'alimentation en eau et des accessoires.

IMPORTANT: Mauvaise application des lignes d'alimentation et accessoires peut entraîner la défaillance ou la fuite.

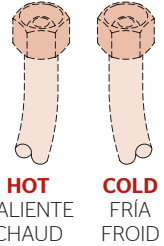

HOT
CALIENTE
CHAUD

COLD
FRÍA
FROID

6A **Point Lines in Bucket**
Guiar las Líneas hacia el Balde
Guide les lignes en le Balde

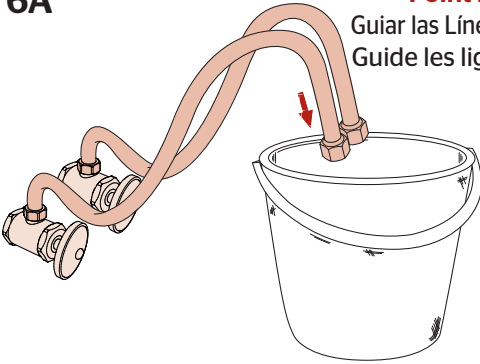

6B **Turn On Water**
Active el suministro de agua
Ouvrez l'eau

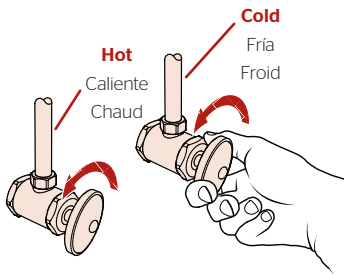

6C **Flush Lines**
Enjuagar las Líneas
Rincer les Lignes

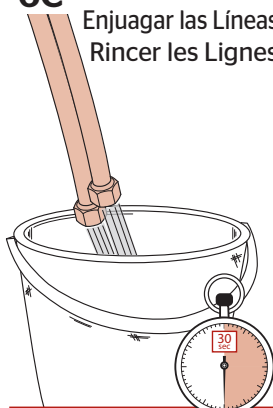

Allow water to run for at least 30 seconds.

Deje correr el agua durante al menos 15 segundos.
Permettez à l'eau couler au moins 15 secondes.

6D **Turn Off Water Supply**
Cierre el suministro de agua
Couper l'alimentation en eau

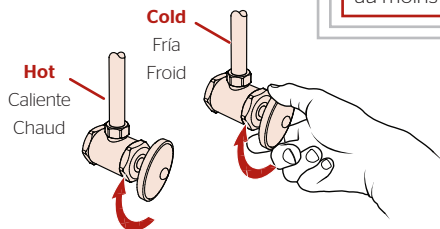

6E **x2**
Hot & Cold
Caliente y fría
Chaud et froid

Quick Install™ Tool

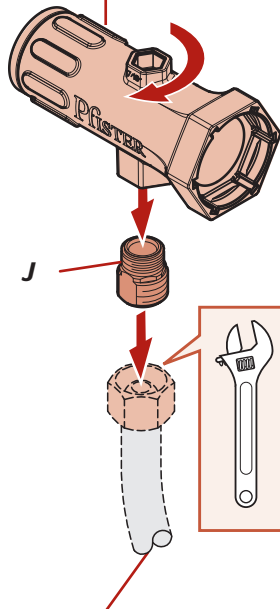

Water supply line

línea de suministro del agua
Ligne d'approvisionnement en eau

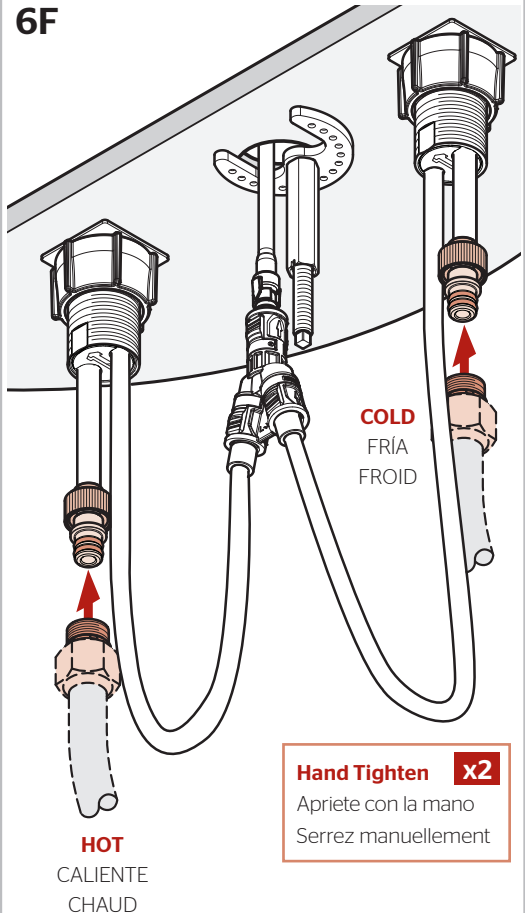

Hand Tighten x2
Apriete con la mano
Serrez manuellement

x2
Hot & Cold
Caliente y fría
Chaud et froid

Water supply line
línea de suministro del agua
Ligne d'approvisionnement en eau

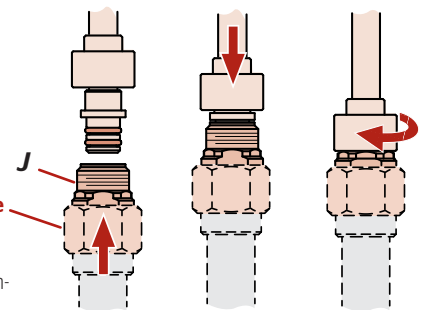

7 Prepare & Install Push & Seal™ Drain

Prepare y instale cuerpo de drenaje Push & Seal™

Préparez & installez le corps de drainage Push & Seal™

No Tools Required for This Step
 No se necesitan herramientas para este paso
 Pas d'outil nécessaire pour cette étape

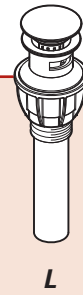

7A Disassemble Pop-Up

Desensamble el cuerpo de drenaje
 Démontez le corps de drainage

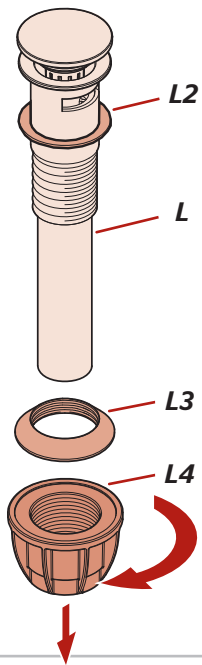

Save Components.
 Reserve los componentes.
 Conservez les composants.

7B

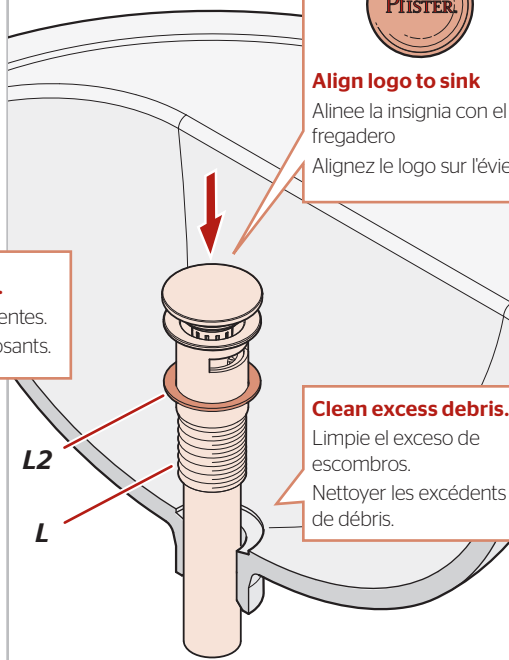

Align logo to sink
 Alinee la insignia con el fregadero
 Alignez le logo sur l'évier

Clean excess debris.
 Limpie el exceso de escombros.
 Nettoyer les excédents de débris.

7C

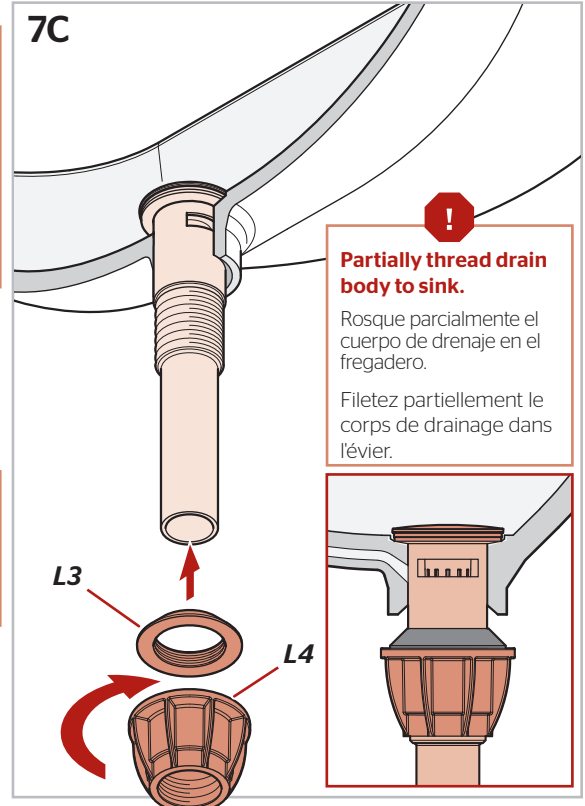

Partially thread drain body to sink.
 Rosque parcialmente el cuerpo de drenaje en el fregadero.
 Filetez partiellement le corps de drainage dans l'évier.

7D

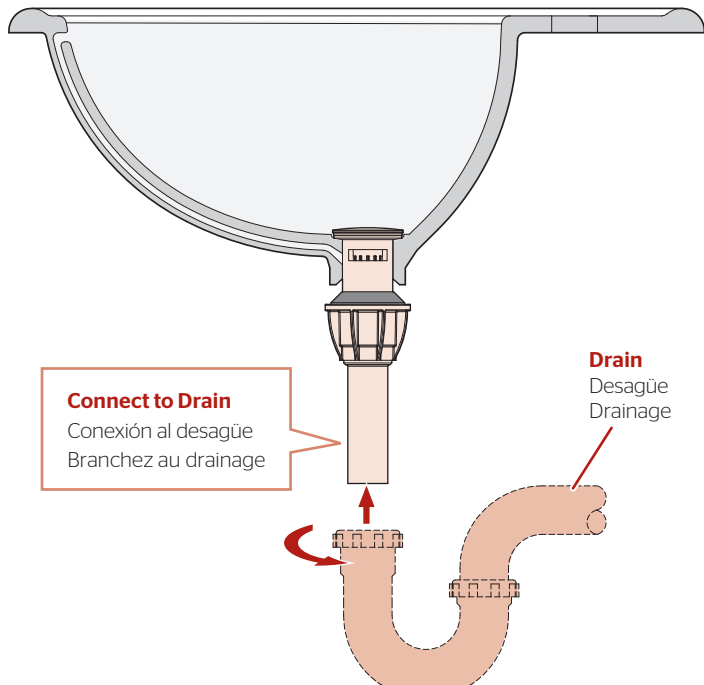

Connect to Drain
 Conexión al desagüe
 Branchez au drainage

Drain
 Desagüe
 Drainage

7E

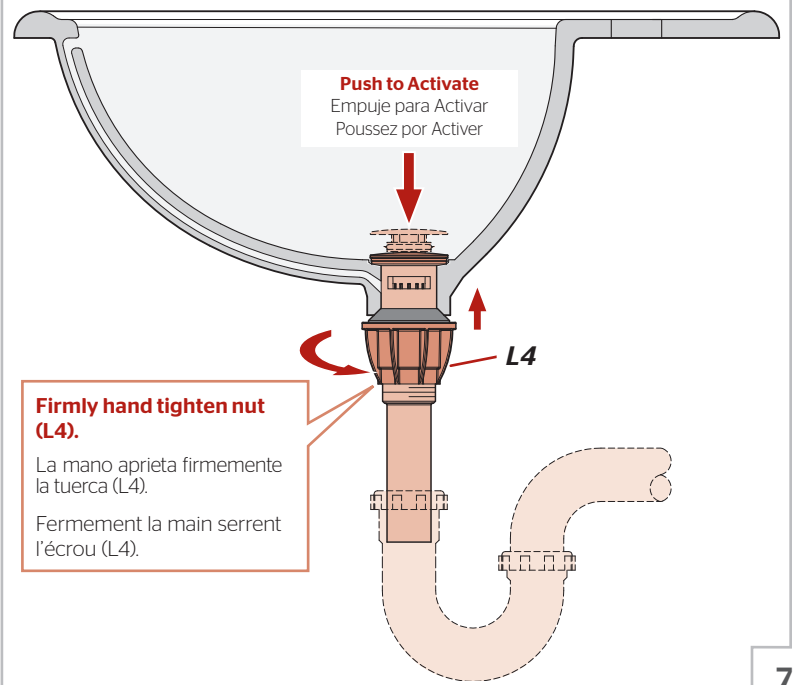

Push to Activate
 Empuje para Activar
 Poussez por Activer

Firmly hand tighten nut (L4).
 La mano aprieta firmemente la tuerca (L4).
 Fermelement la main serrent l'écrou (L4).

8

Turn On Water & Confirm Proper Installation

Active el suministro de agua y confirme que la instalación está adecuadamente efectuada

Ouvrez l'eau et confirmez que l'installation est correcte

8A Remove Aerator Retire el aereador Retirez l'aérateur

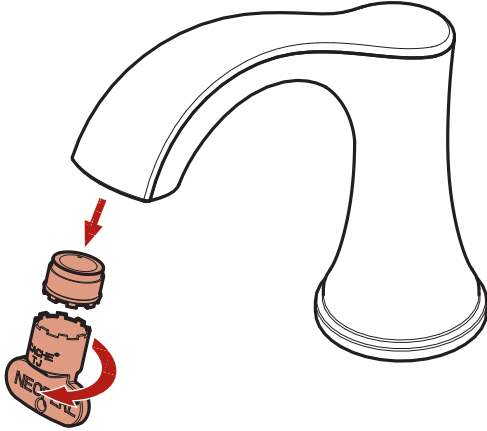

8B

Turn On Water Supply Abra el suministro de agua Ouvrez l'alimentation en eau

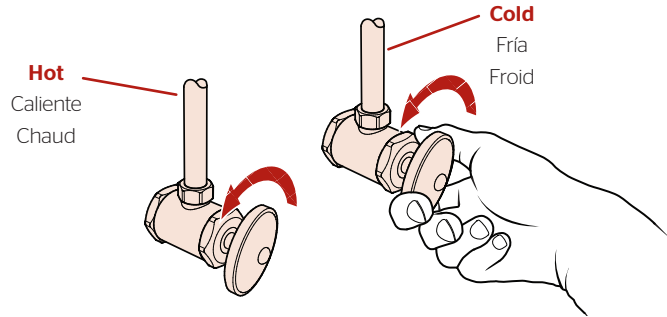

Check for leaks above and below the sink.

Revise si hay fugas encima y debajo del fregadero.

Assurez-vous qu'il n'y a pas de fuite au dessus ou au dessous du lavabo.

8C Turn On Faucet Active el grifo Ouvrez le robinet

Open
Abierta
Ouvverte

Hot
Caliente
Chaud

Open Slowly
Abra lentamente
Ouvrez lentement

Cold
Fría
Froid

Open
Abierta
Ouvverte

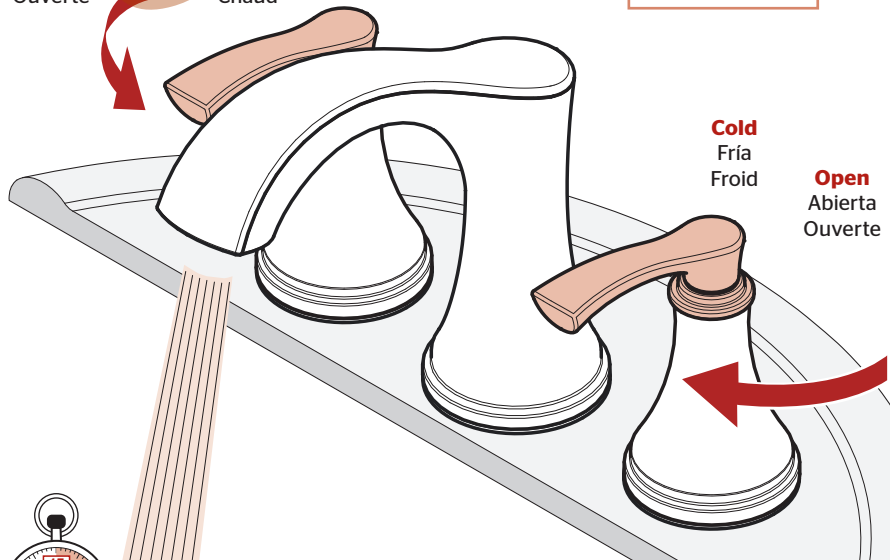

Allow hot & cold water to run for at least 15 seconds each.

Deje correr el agua caliente y fría durante al menos 15 segundos cada una.

Laissez couler l'eau chaude et l'eau froide pendant au moins 15 secondes.

8D Reinstall Aerator Reinstale el aereador Réinstallez l'aérateur

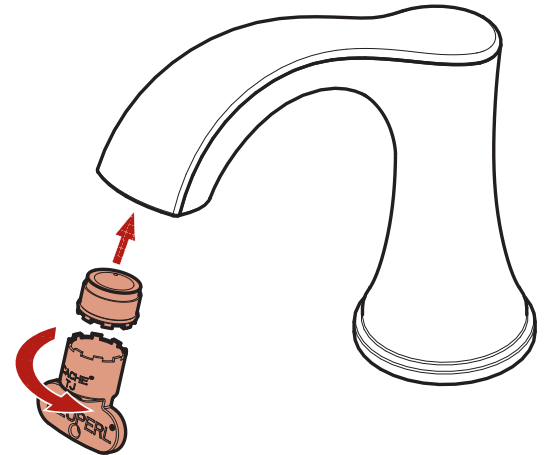

Hand Tighten

Apriete con la mano
Serrez manuellement

For Additional Installation Help:

Para la instalación adicionales de ayuda:

Pour les aides supplémentaires à l'installation:

Pfister

1-800-PFAUCET (732-8238)
pfisterfaucets.com