

Barrette Vinyl Fence Kits

Assembly and Installation Instructions

PLEASE READ OWNER'S MANUAL COMPLETELY
BEFORE ASSEMBLING YOUR FENCE.

ALL STATED SIZES ARE NOMINAL DIMENSIONS.

34106808BOM V2 11/13

Owner's Manual

Version

2.0

Privacy Panels

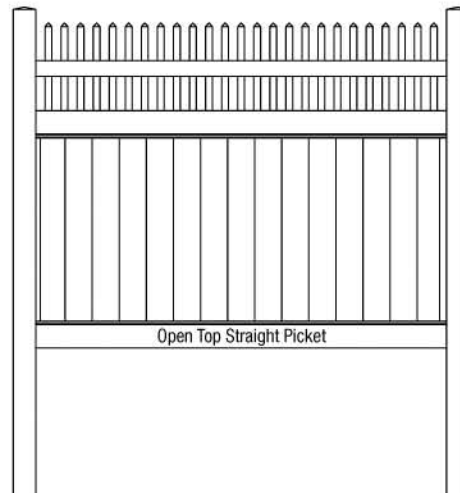
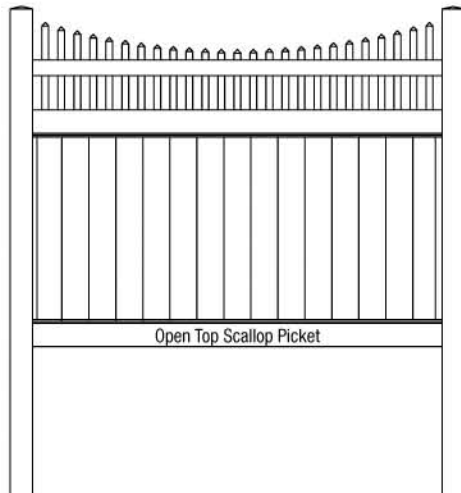
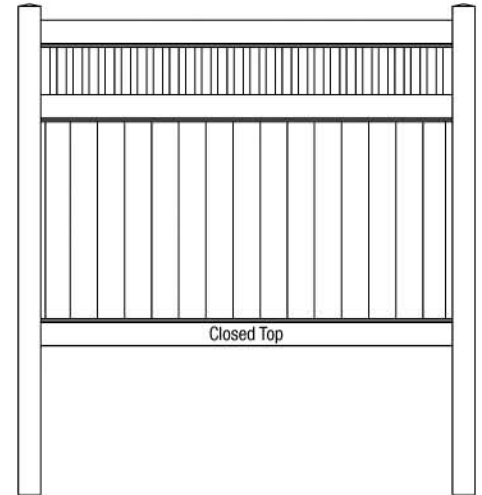
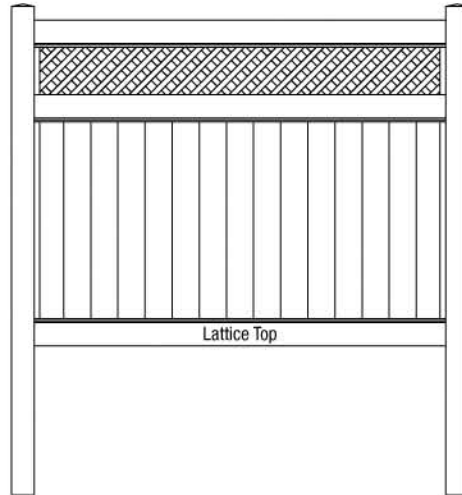
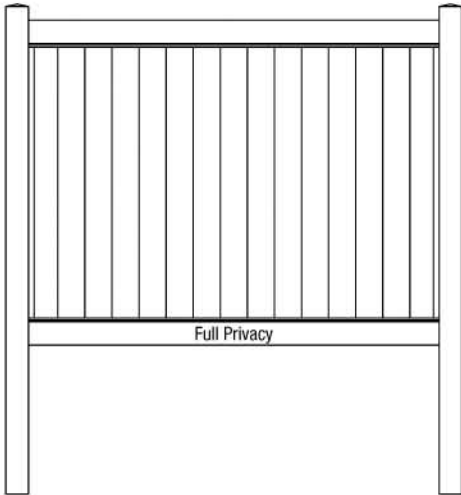

* Select styles available by retailer

To register your product, please visit: www.barretteoutdoorliving.com/product-registration



Transferable Limited Lifetime Warranty

What is covered: Barrette Outdoor Living warrants vinyl and aluminum products to include; vinyl and aluminum fence, vinyl and aluminum railing and plastic lattice against defects or workmanship for as long as you own your home. Barrette Outdoor Living will at its option replace the product in question with new product of the same or equivalent value at no charge. Barrette Outdoor Living warrants these products against peeling, flaking, splintering, corrosion, rusting or abnormal discoloration under normal use. This warranty extends to the original purchaser or transferee as specified herein on the products noted above. Separate and distinct warranties for hardware and other products are not covered under this warranty.

What this warranty does not cover: This limited warranty does not cover damage resulting from accident, unreasonable use, neglect, alteration, improper service, improper installation, acts of God or any other causes not arising out of defects in materials or workmanship. Additionally, this warranty does not cover costs of installation, removal, reinstallation or surface mold and mildew created by excessive environmental conditions. Any service or repair provided outside the scope of this limited warranty shall be at Barrette Outdoor Living's rate and terms then in effect.

What do we do to correct the problems? Should your Barrette Outdoor Living product prove defective under warranty, reference the website or call the phone number listed below. Your problem will be assigned a tracking number and an authorized Barrette Outdoor Living representative will contact you to arrange a convenient time to schedule an onsite inspection, or request pictures, if need be. If after inspection product is deemed to be manufacturer defect we will make arrangements to rectify the issue. You must have proof of your purchase in order for the problem to be corrected.

Transferee Coverage: Warranty coverage will be extended to one transferee on the above listed products with the following limitations. Transferee must obtain an original or copy of the initial sales receipt (with proof of date) from the previous owner(s). Additionally, if fence is purchased from a builder or installer, documentation must be supplied that names the product installed on property and date of transfer.

Registration: To activate this warranty, the online registration card must be completed and returned to Barrette Outdoor Living within 30 days of installation.

Additionally, this Warranty does not cover damage associated with surface mold and mildew resulting from environmental conditions including air pollution, or any other causes not arising out of defects in materials or workmanship by Barrette Outdoor Living.

This Warranty does not cover costs of removal or disposal of product, or reinstallation of replacement product. Any service provided outside the scope of this limited Warranty shall be at Barrette Outdoor Living's standard rate and terms then in effect.

Barrette Outdoor Living reserves the right to discontinue or modify any of its products, including the color of its products, without notice to the homeowner/consumer, and Barrette Outdoor Living does not warrant that any replacement material will match or be identical to the original product as replacement products may vary in color or gloss in comparison to the original product as a result of normal weathering. If Barrette Outdoor Living replaces any material under this Warranty, it may substitute products designated by Barrette Outdoor Living to be of comparable quality or price range in the event the product initially installed has been discontinued or modified.

THIS WARRANTY IS IN LIEU OF ALL CONDITIONS OR WARRANTIES, EXPRESS, OR IMPLIED INCLUDING BUT NOT LIMITED TO ANY IMPLIED CONDITIONS OR WARRANTIES OR MERCHANTABILITY OR FITNESS FOR A PARTICULAR PURPOSE ON THE PART OF Barrette OR ITS LICENSORS, SOME STATES DO NOT ALLOW THE EXCLUSIONS OF IMPLIED WARRANTIES OR LIMITATIONS OF HOW LONG AN IMPLIED WARRANTY LASTS, SO THE ABOVE LIMITATIONS MAY NOT APPLY TO YOU. IF THE PRODUCT IS DEFECTIVE PER THE ABOVE COVERAGES, YOUR SOLE AND EXCLUSIVE REMEDY SHALL BE REPAIR OR REPLACEMENT AS PROVIDED ABOVE. BARRETTE AND ITS LICENSORS SHALL NOT BE LIABLE FOR ANY DAMAGES, LOSS OF USE, LOSS OF PROFITS OR INTERRUPTION OF BUSINESS WHETHER SUCH ALLEGED DAMAGES ARE BASED IN WARRANTY, TORT, CONTRACT, OR INDEMNITY. SOME STATES DO NOT ALLOW THE EXCLUSION OF LIMITATIONS OF INCIDENTAL OR CONSEQUENTIAL DAMAGES, SO THE ABOVE LIMITATIONS MAY NOT APPLY TO YOU. This warranty is valid only in the United States and Canada.

For any specific questions about the Barrette Outdoor Living Warranty or to make a warranty claim please contact Barrette Outdoor Living by visiting our website www.barretteoutdoorliving.com, emailing or calling 1-800-336-2383.

Begin your warranty coverage and register your Barrette Outdoor Living product at
www.BarretteOutdoorLiving.com

13

Measure panel plus the dimensions from center of 2nd post to center of next and dig the third post hole accordingly. Repeat steps until completed.

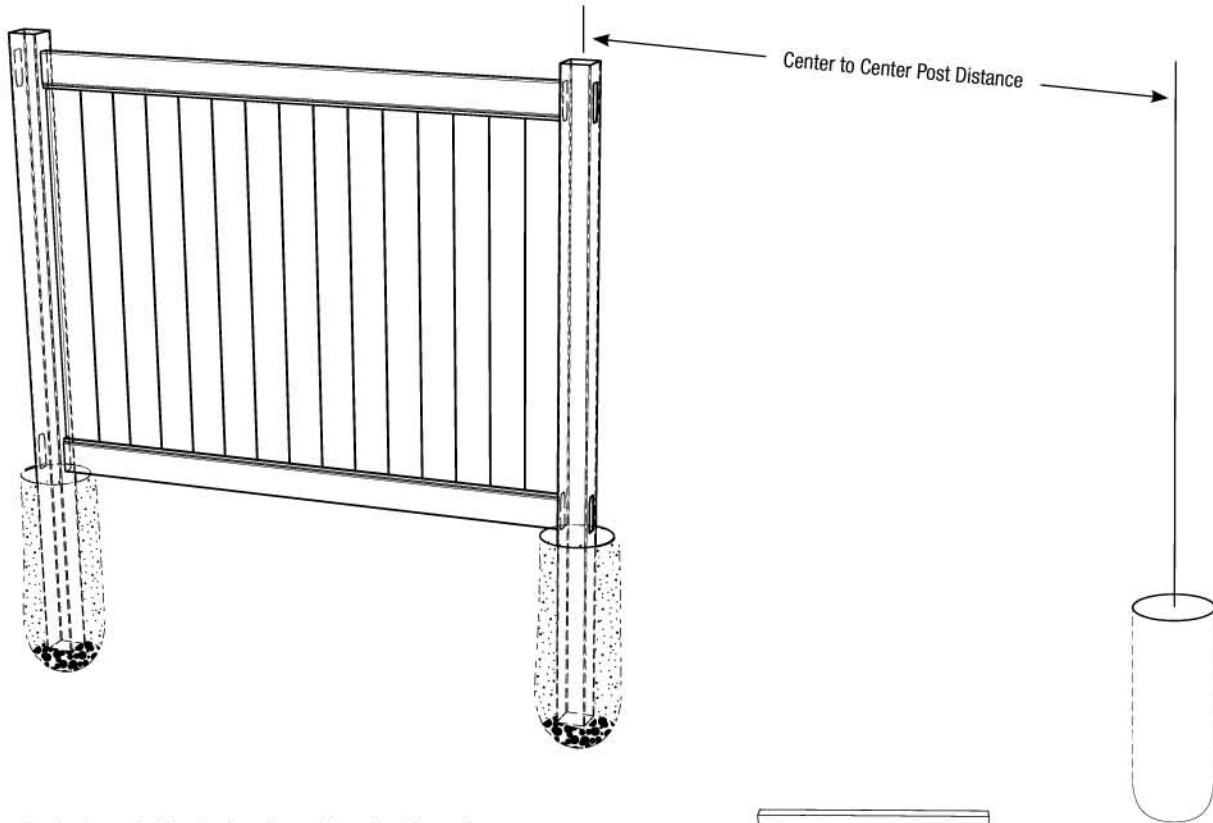
**14**

Apply glue on inside rim of post caps then attach to posts.

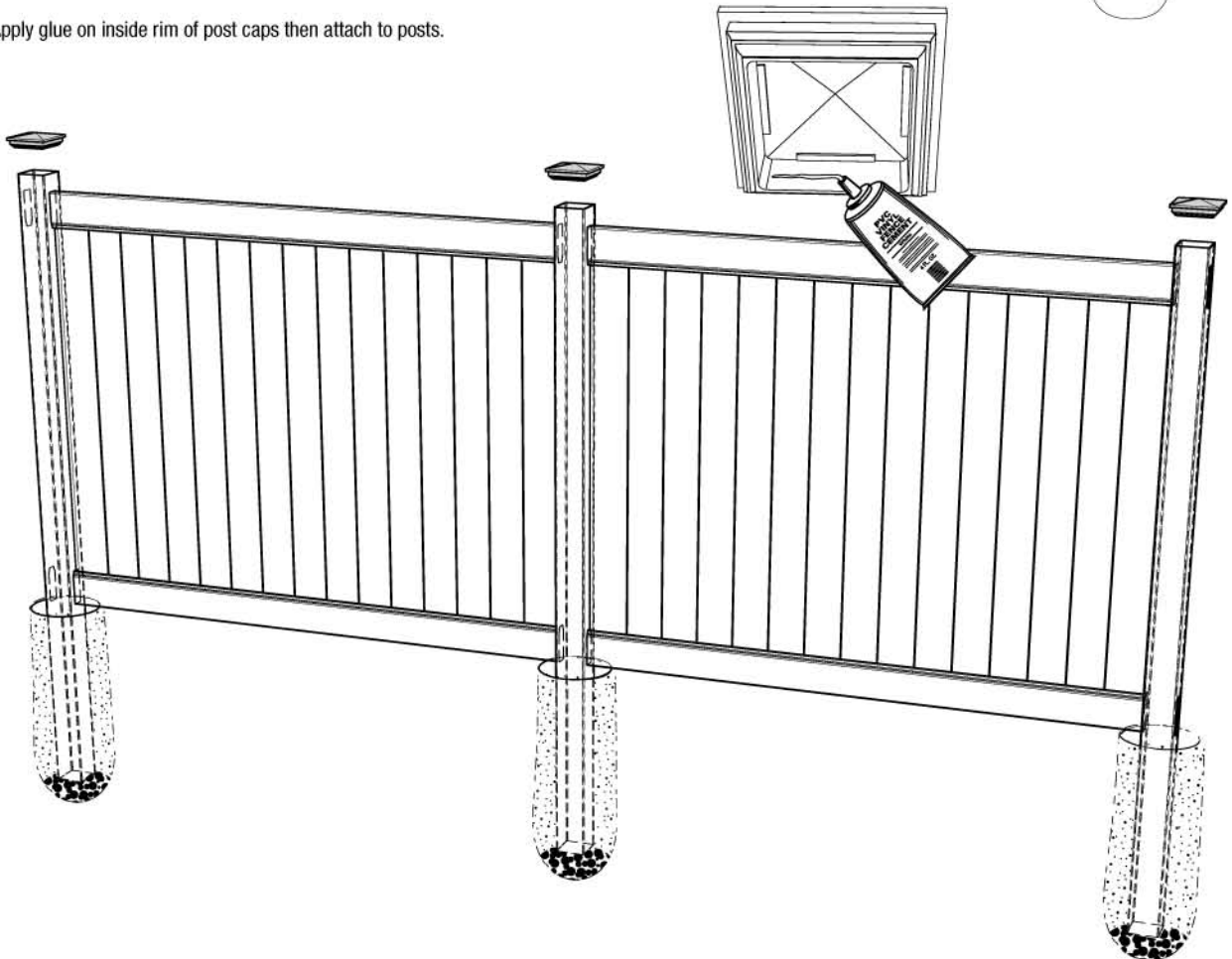

10_c

Insert the top rail into post route holes of first post then guide rail over picket tops. Proceed to Step 12.

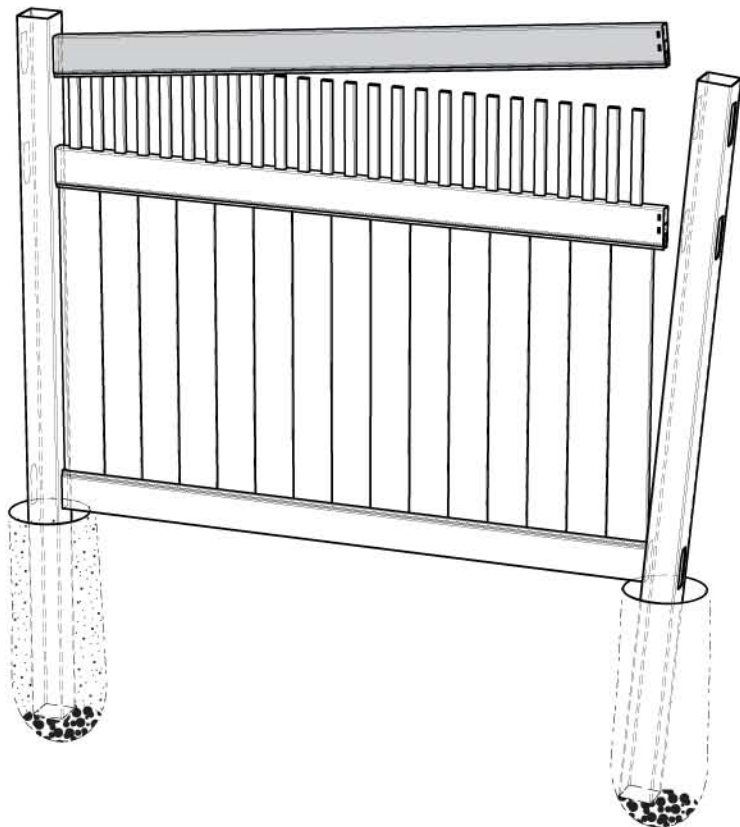

11_a

For open top picket fences follow Step 11 for assembly. Attach middle rail into left side of post route only then guide rail over boards. Insert top rail into left post route holes of first post only.

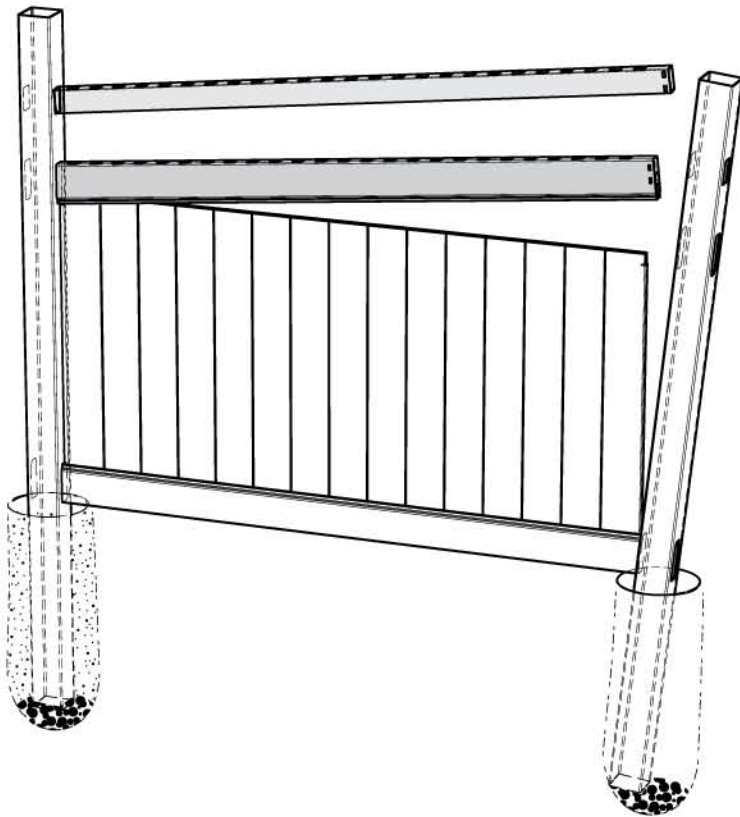

11_b

Insert pickets down through top and middle rail. Note: Scalloped and Arched panels have pickets/boards that are numbered. Start from left side with the #1 picket/board first.

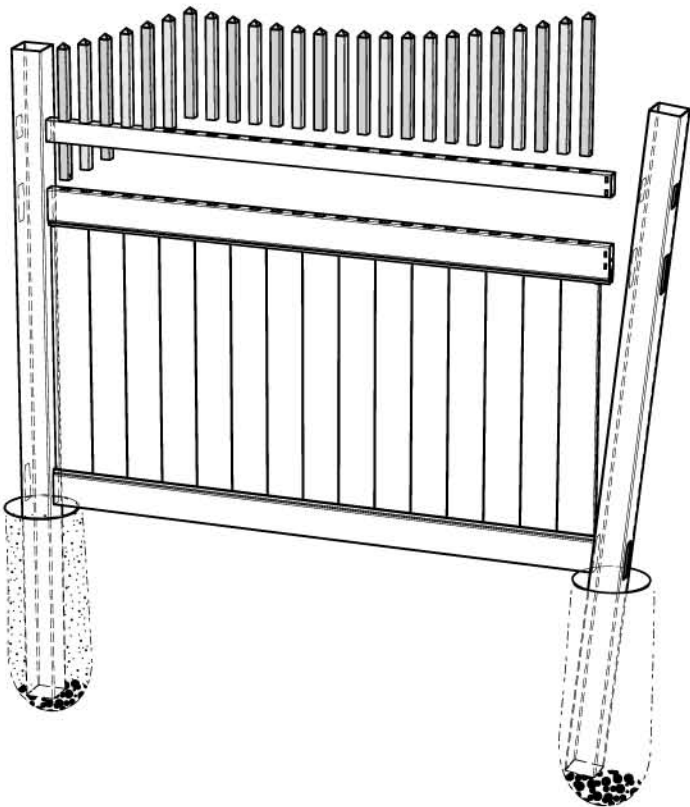

12

Insert the completed fence panel into the route holes of the second fence post. Plumb and level the post and add concrete according to manufacturers instructions to top of hole.

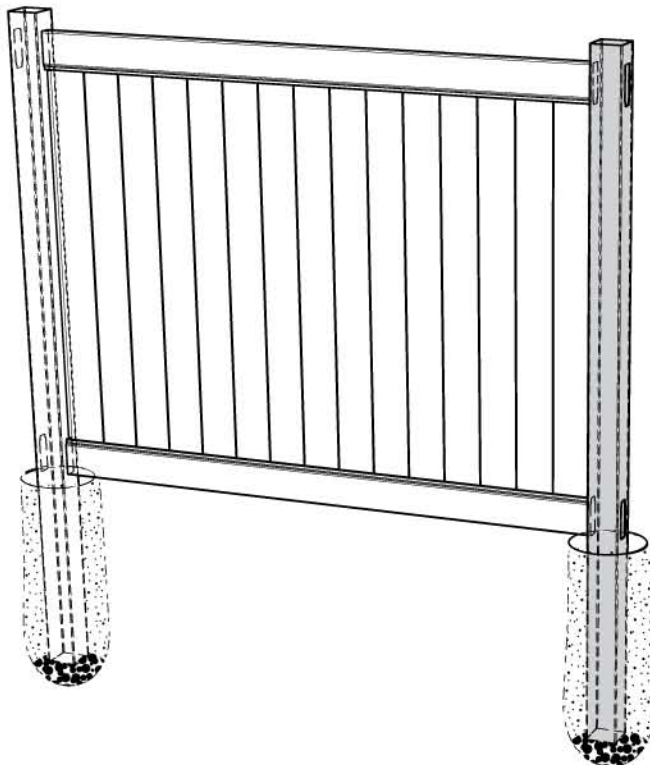

- 9_a** For lattice top fences follow Step 9 for assembly. Add the lattice insert over the top of the lattice (May not be required for certain styles). Place into the middle rail followed by the top rail.

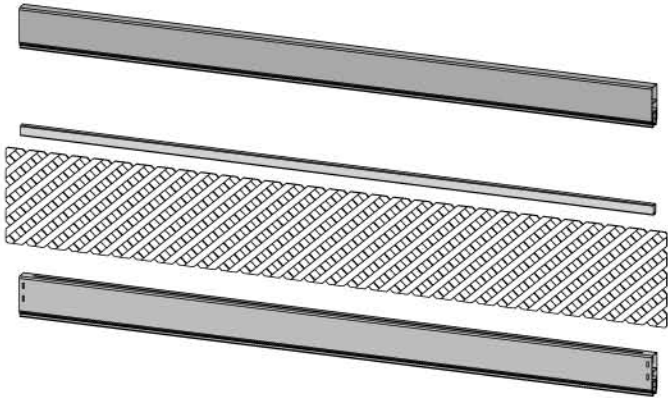

- 9_b** Finally, add the completed assembly into the route holes of the first post. Proceed to Step 12.

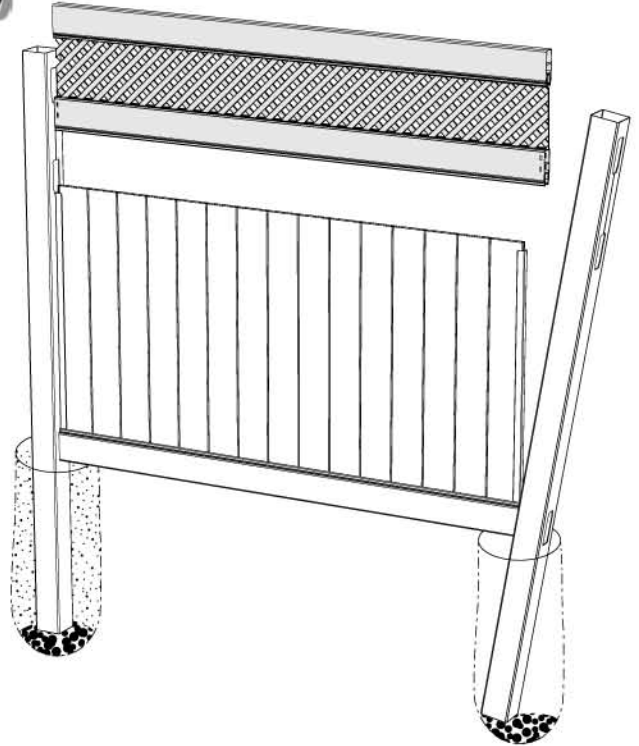

- 10_a** For closed picket top fences follow Step 10 for assembly. Attach middle rail into left side of post route then guide rail over boards.

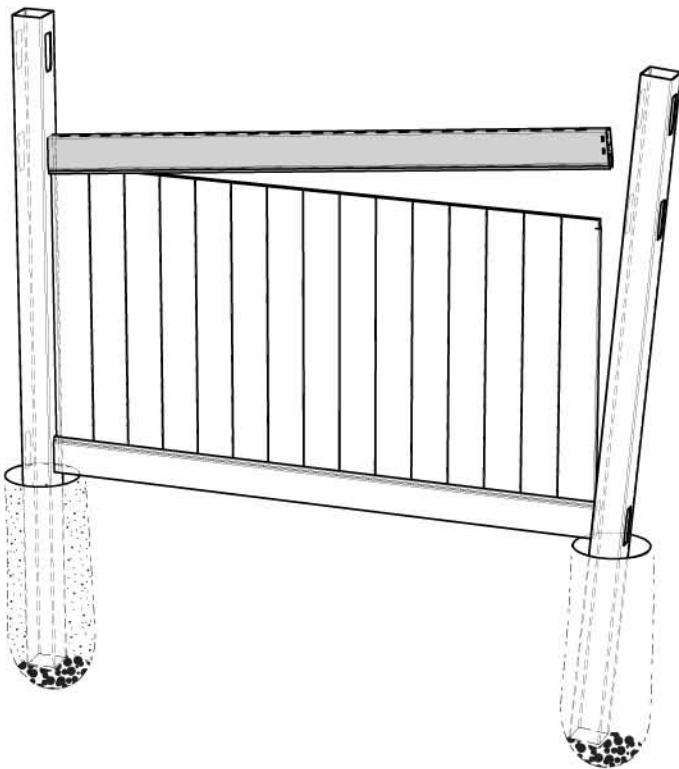

- 10_b** Insert pickets down through middle rail.

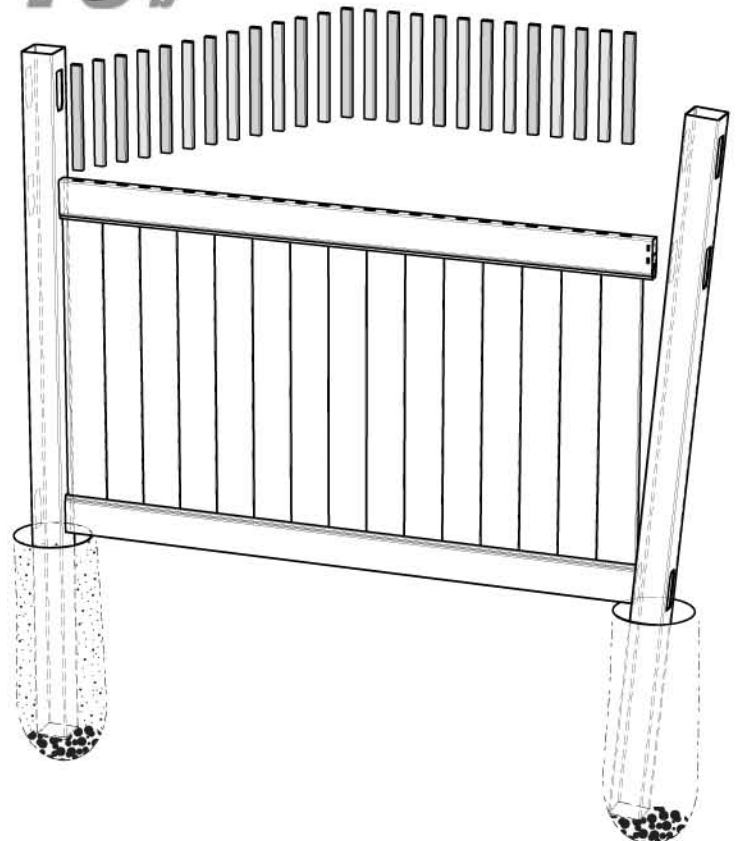

5 When present or included, insert aluminum into bottom rail, then insert bottom rail into bottom post route hole of first post only. Panels with 7" rails do not require aluminum inserts.

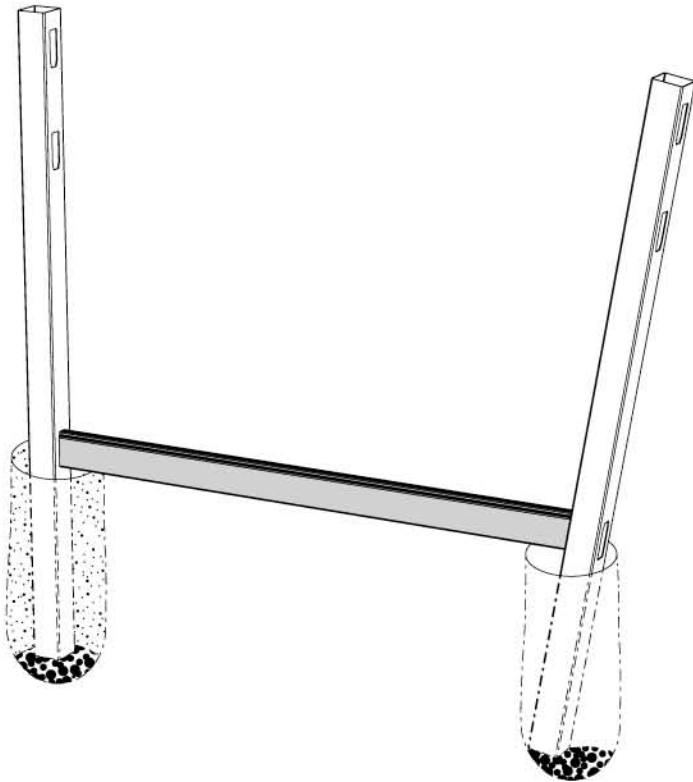

6 Next, attach U-Channels to boards.

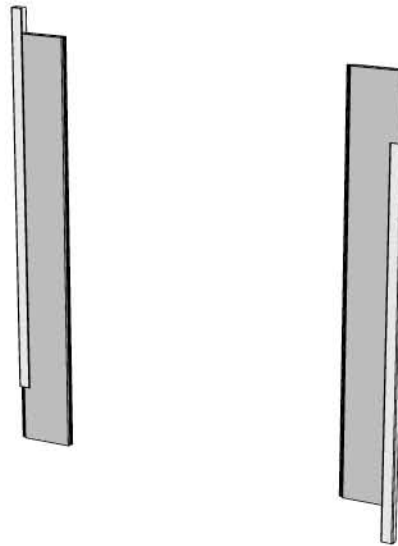

7 Insert boards into bottom rail ensuring U-Channels are on both ends. Start from first installed post and work towards second post

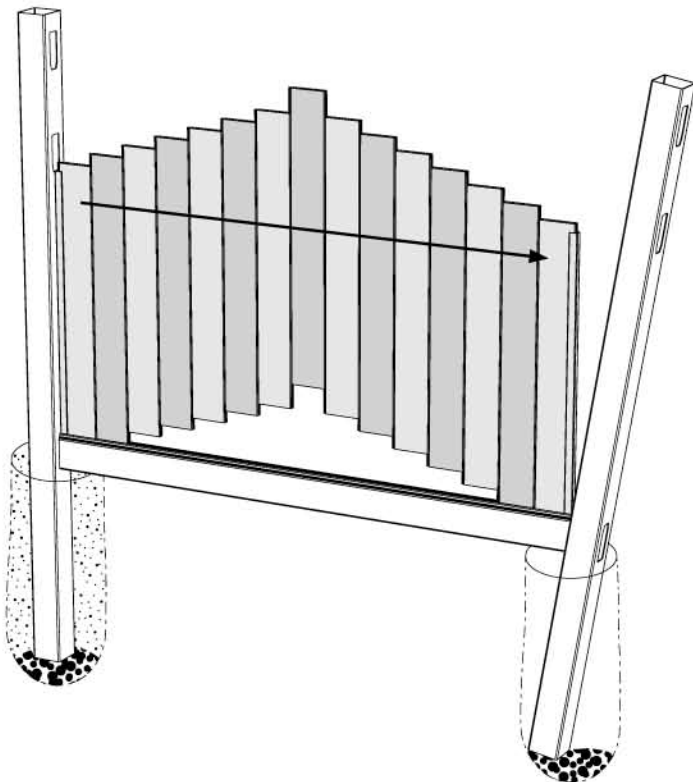

8 For full privacy fences follow Step 8 for assembly. Insert the top rail into the first top hole post route then guide over top of boards. Proceed to Step 12.

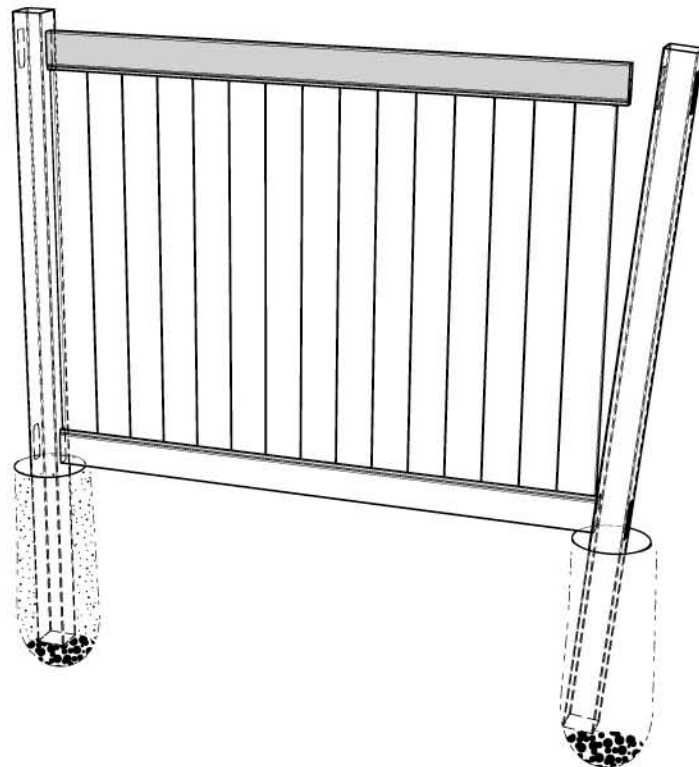

1

Mark the fence location using string and line stakes.

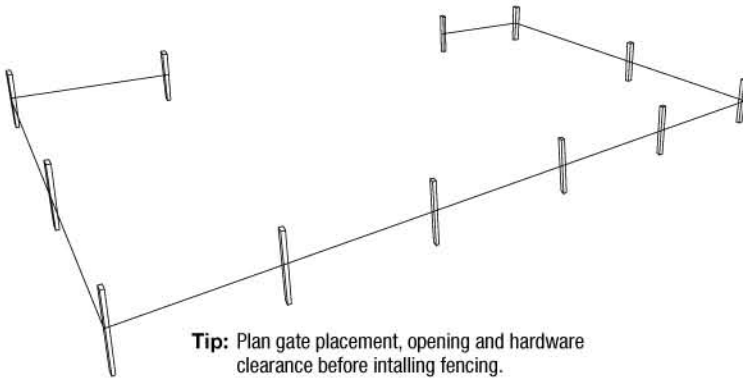

Tip: Do not pre-dig all post holes. To ensure proper post spacing install post-panel-post-panel-etc.

2

Dig post holes 10" in diameter to your specified frost line, plus 6". Use the Center to Center measurements of the fence model being installed for the Center to Center Post Distance.

If a fence panel is being used that is less than the width of a full panel, or if posts are being used other than 5" in width, measure the width of the panel and add the width of one post, that will be the Center-to-Center post distance of the holes.

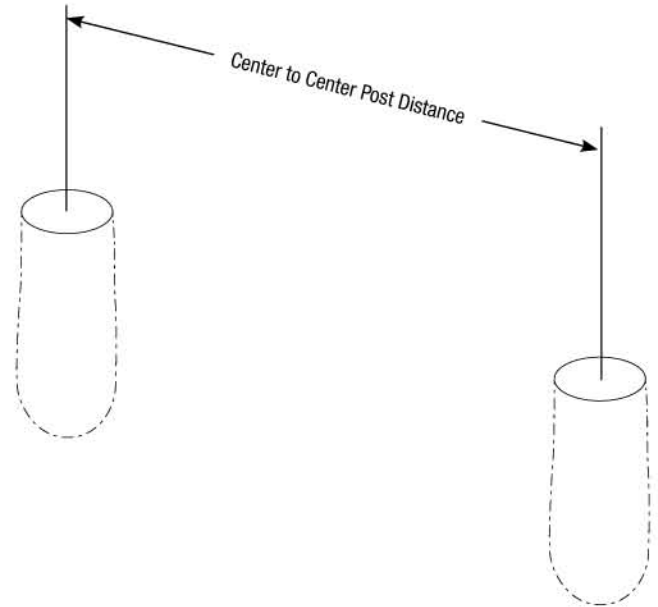

3

*If frost line does not exceed 30", put 6" of gravel into bottom of both holes and insert posts. Add concrete to first post hole according to manufacturers instructions to top of hole. Ensure first post is plumb and level. Let concrete set making sure panel will be 2" above ground. Do not add concrete to second hole until later in installation.

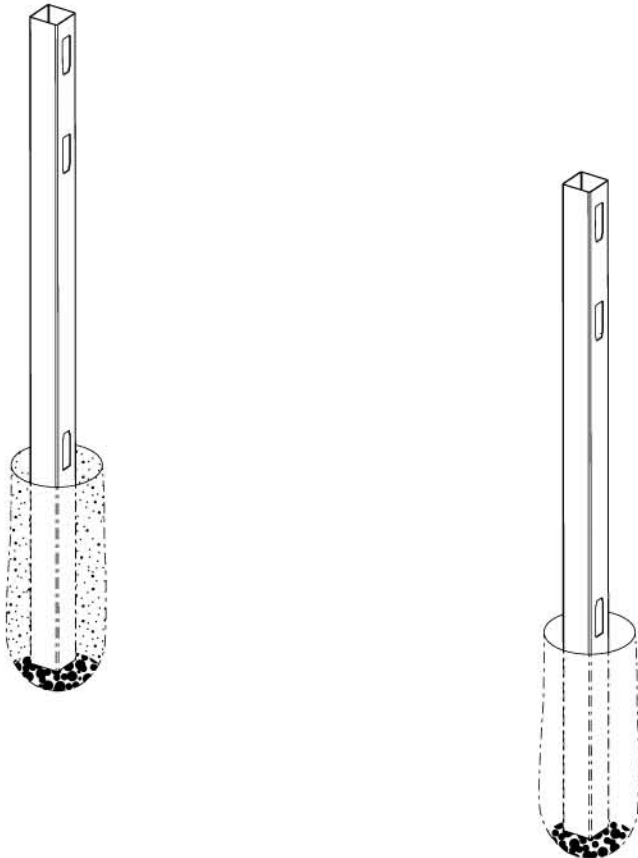

4

If frost line exceeds 30" dig hole to the appropriate depth and then add 6" of gravel for post drainage. Add concrete according to manufacturers instructions until a depth of 30" remains and let concrete set to create a footing. Set post in hole ensuring it is plumb and level. Fill hole with concrete according to manufacturers instructions. Make sure panel will be 2" above ground, or check with local building codes on fence height requirements. Go to step 5.

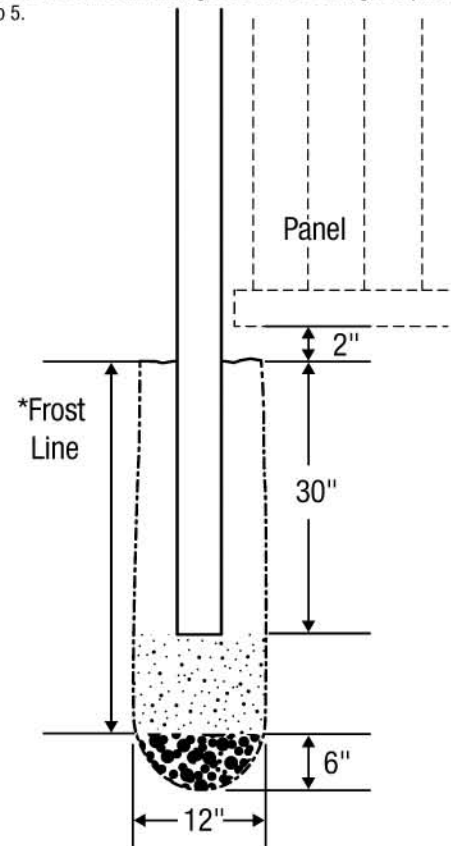

*Check local codes for frost line depth and regulations.

Thank you for choosing the Barrette Outdoor Living Fence. Please read the instructions completely before assembling your fence. Retain manual and your dated sales slip for future reference and warranty claims.

Before You Begin...

Check your local zoning laws.

- Local zoning laws and Home Owners Associations may regulate the location, style and height of your fence or even require a permit signoff beforehand.
- Check local codes for frost line depth and regulations.
- Additional products and assembly may be required to meet wind code requirements. Notice of acceptance (NOA) can be found at www.miamidade.gov/building/pc-search_app.asp

Contact your local utilities companies.

- You must have the utility companies clearly mark your property for electrical, gas or water lines to avoid puncturing any unseen underground utilities.



Pay to mark your property line.

- Being proactive will save you time and money from any disputes from neighbors.

Panel Assembly:

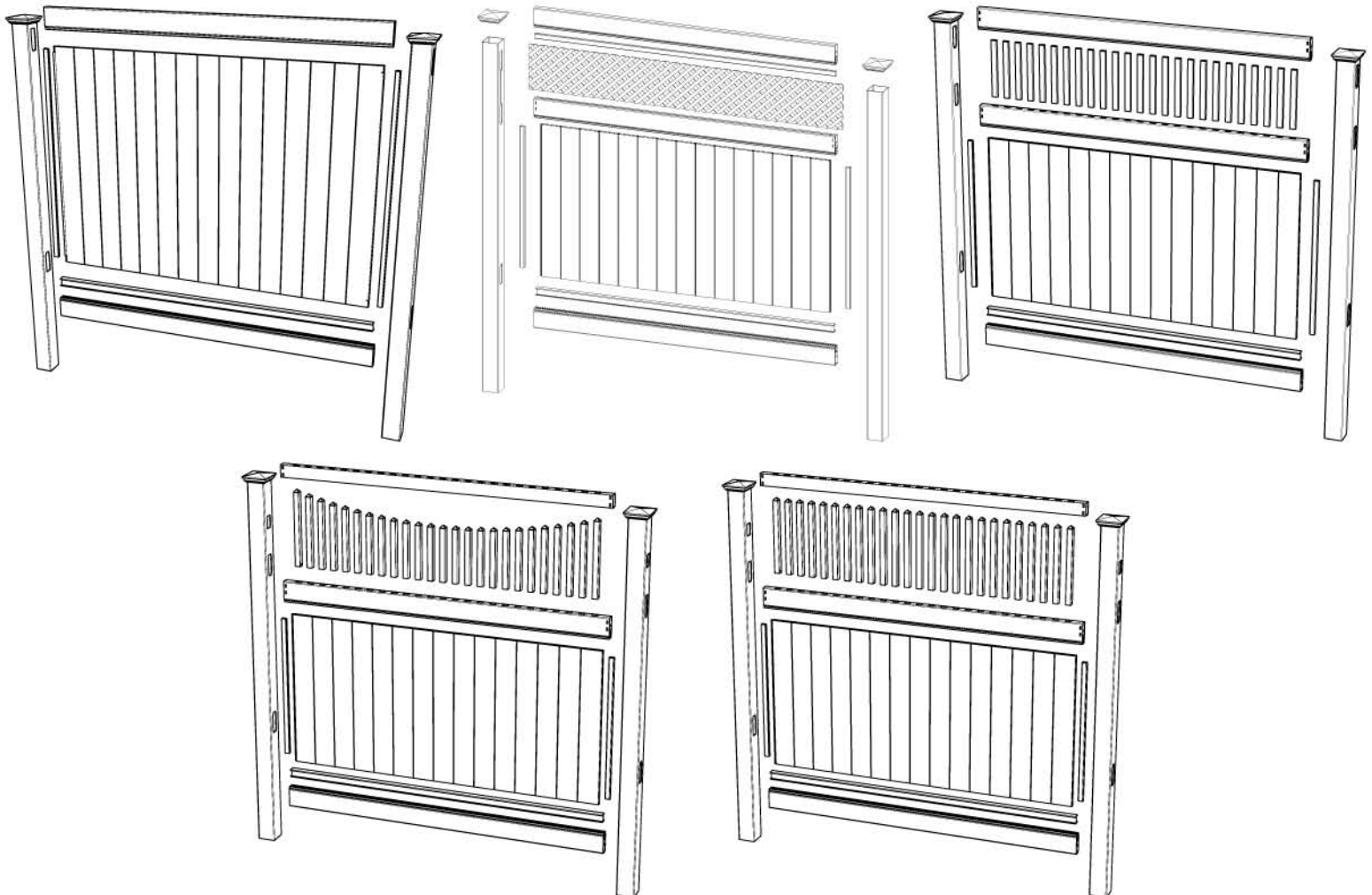

*Not all styles require an aluminum insert in bottom rail

Material Checklist:

- | | |
|--|---|
| <input type="checkbox"/> Flat Head Screwdriver | <input type="checkbox"/> Safety Glasses |
| <input type="checkbox"/> Circular Saw or Hand Saw | <input type="checkbox"/> String Line Stakes |
| <input type="checkbox"/> Concrete | <input type="checkbox"/> Spool of String |
| <input type="checkbox"/> Coarse Gravel (6" per hole) | <input type="checkbox"/> Vinyl Cement |
| <input type="checkbox"/> Water for Concrete | <input type="checkbox"/> Line Level |
| <input type="checkbox"/> Clean Rags | <input type="checkbox"/> Tape Measure |
| <input type="checkbox"/> Post Hole Digger | <input type="checkbox"/> Shovel |
| | <input type="checkbox"/> Rubber Mallet |

ATTENTION: Before you assemble the fence:

PLEASE TAKE A COMPLETE INVENTORY OF ALL PARTS USING THE KIT CONTENTS.

DO NOT ATTEMPT TO ASSEMBLE THE FENCE IF PARTS ARE MISSING OR DAMAGED.

Please do not return the product to the store, for assistance or replacement parts call:

1-800-336-2383