



Aluminum Railing

INSTALLATION INSTRUCTIONS
FOR POST, RAIL AND STAIR RAIL



Read all instructions prior to installing product.

Refer to manufacturers safety instructions when operating any tools.

To register your product, please visit:

freedom.barretteoutdoorliving.com

⚠ WARNING:

- Improper installation of this product can result in personal injury. Always wear safety goggles when cutting, drilling and assembling the product.
- Incorrect installation may cause harm to the product or individual.
- Not pool code approved.

NOTICE:

- DO NOT attempt to assemble the kit if parts are missing or damaged.
- DO NOT return the product to the store, for assistance or replacement parts call: 1-800-336-2383.

BEFORE YOU BEGIN:

It is the responsibility of the installer to meet and/or exceed all code and safety requirements and to obtain all required building code permits.

The deck and railing installer should determine and implement appropriate installation techniques for each installation.

FASTENERS NEEDED:

Depending on Installation Method

5/16" Diameter Galvanized Bolts with Nuts (For Concrete)
5/16" Masonry Anchors (For Concrete)
#10x3 1/2" Deck Screws (For Deck/Wood)

TOOLS NEEDED:

Safety Glasses
Pencil
Level
Chalk Line
3/8" & 1/8" Drill Bits
Drill
Hacksaw or Chopsaw
Tape Measure
Scissors or Utility Knife
Tape
Rubber Mallet
Clamps
Fine-tooth Carbide Blade
Deck Board (for Stair Rail Spacing)
2"x8" Wooden Blocks (For Post Support)
Shims (Steel Washers)

Post Kit

Components:

Description
Post
Pyramid Post Top
Base Trim
Secondary Mounting Plate
1/4" x 2 1/2" Phillips Flat Head Screws
Template

Rail Kit

Components:

Description
Rail Cap
Top Rail
Bottom Rail
Snap&Stay™ Locking Strips
Support Block(s)
Rail Bracket Kit*
Angle Bracket Kit*

*Bracket kits are sold separately and include 1 1/2" screws.

Stair Rail Kit

Components:

Description
Rail Cap
Top Rail
Bottom Rail
Snap&Stay™ Locking Strips
Stair Bracket Kit*

*Bracket kits are sold separately and include 1 1/2" screws.

Baluster Kits:

(Sold Separately)

Description
Square Baluster Kit
Twisted Baluster Kit
Glass Kit

1

Planning:

- a. Posts are designed and manufactured to accept $\frac{5}{16}$ " fasteners (sold separately). Be sure to use appropriate fasteners for your installation.
- b. Determine the desired rail placement and snap a chalk line onto the mounting surface to ensure that all posts are aligned properly (Fig 1).
- c. Plumb and level the posts using steel washers as shims (sold separately) (Fig. 2), secure the posts in place with appropriate fasteners (sold separately) and install base trim on each post (Fig. 3).
- d. Determine the appropriate method for installing your posts below.

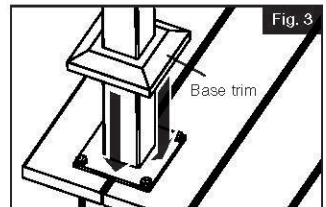
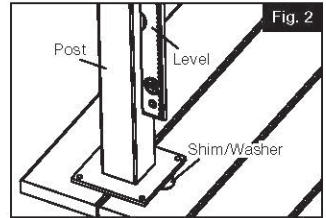
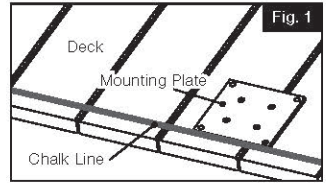

Concrete Surface Installations:

- a. Purchase four $\frac{5}{16}$ " masonry anchors according to local building codes.
- b. Mark holes through mounting plate onto concrete surface and follow masonry anchor manufacturer installation instructions.
- c. Install base trim around post (Fig. 3).

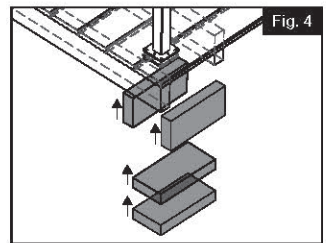

Deck/Wood Surface Installations:

- a. For decking applications, use the provided secondary mounting plate when securing posts in place.
- b. Beneath all post locations install at least two 2"x8" blocks using at least three #10x3 $\frac{1}{2}$ " deck screws penetrating through the joists at least 1 $\frac{1}{2}$ " into the blocks (sold separately) (Fig. 4 & 5).
- c. Mark holes through the bottom plate of steel post onto deck surface. Remove steel post and drill $\frac{3}{8}$ " holes in all four marks through deck board and blocking.
- d. Purchase $\frac{5}{16}$ " diameter galvanized bolts and nuts approximately 1" longer than the distance between steel mounting plates (minimum 5").
- e. Push bolts through post plate and attach separate bottom plate from beneath deck surface (Fig. 6). Posts can be leveled as needed by using shims.
- f. Tighten bolts, secure in place and install base trim around each post (Fig. 3).

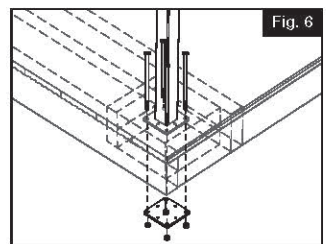
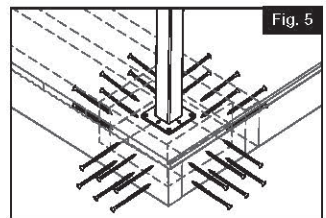

2

- a. Cut out bracket template from side of post box, and align it with the base trim and post. Secure template in place using a piece of tape. Pre-drill through the desired marked locations on the template using a $\frac{1}{8}$ " drill bit.
- b. Remove template, align brackets (Fig. 7) with the holes ensuring the brackets are square, and fasten brackets in place using the $1\frac{1}{2}$ " screws provided.

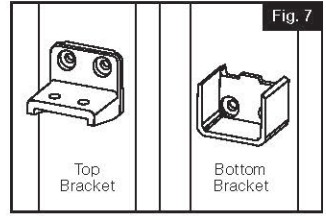

RAIL INSTALLATION - FOR SQUARE AND/OR TWISTED BALUSTERS

1

Cut Rails to Length (Top & Bottom Rails, Top Rail Cap):

- a. Place bottom rail across post opening leaving equivalent spacing from last baluster to post on each end. Make sure there is even spacing from baluster hole to post (Fig. 1)
- b. Mark rail flush to post.
- c. From marked lines, mark additional parallel line $\frac{1}{4}$ " from first line to allow for bracket clearance (Fig. 2).
- d. Align top rail and top rail cap with bottom rail and mark all before cutting to size. Then cut all to same length with a fine-tooth carbide blade. (Fig. 3).

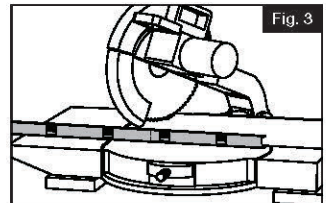
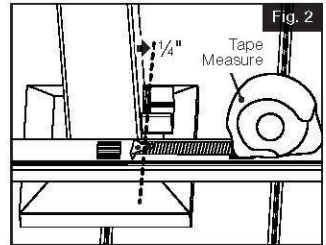
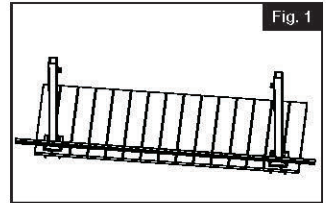
**2**

Assemble Railing Section:

- a. Place top and bottom rail on a smooth, flat and clean surface. Then, align the top and bottom rails so that the ridges inside the rails are oriented on the same side (Fig. 4).

NOTE:

There are two (2) ridges on both sides that are different sizes.

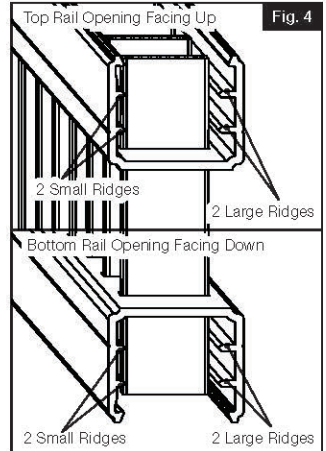
**4**

b. Insert all balusters through the square holes in rails, making sure the hole in each baluster goes in the same direction facing the side with the two (2) small ridges (Fig. 5).

c. Make sure the balusters in the rails are about 2" above the rail and in-line with each other (Fig. 5).

d. Snap in bumps from locking strip into holes of the baluster for both top and bottom rails. Make sure arrows on locking strip face rails (Fig. 6).

e. If the rails were cut shorter in step 1, then there will be some extra locking strip at the end of install. Use scissors or a utility knife to trim off the excess, while leaving approximately 2" after the last engaged bump.

f. Pull the top and bottom rails towards ends, guiding the rails over the locking strips until snug.

g. Stand rail section up and fully lock balusters into the rails. Place one foot on the top of the bottom rail, between the second and third baluster while at the same time placing a hand under the bottom of the top rail between the second and third baluster. Push with foot and pull with hand until locking is completed. You should hear a snap as the strip locks into the rail. Repeat this process for the middle and the end of the panel (Fig. 7 & 8).

NOTE:

If no snap is heard or felt, use a rubber mallet to tap underneath of top rail to ensure a full connection.

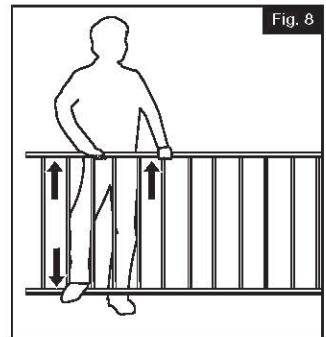
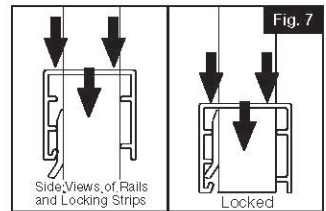
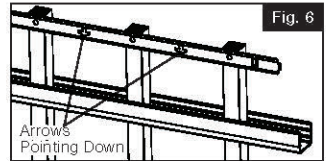
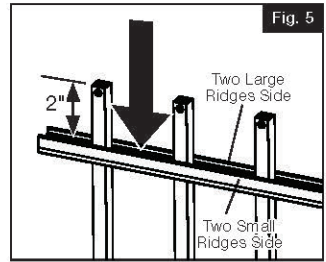

3

Install Support Block:

Pivot support block in place under the rail (Fig. 9).

NOTE:

If using a section longer than 6', use two (2) support blocks (included with 8' panels) and distribute evenly across length of panel. Secure support block(s) to the mounting surface using 1½" screw(s) provided and press cover into place using plastic plug(s) (Fig. 10).

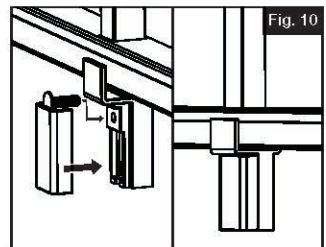
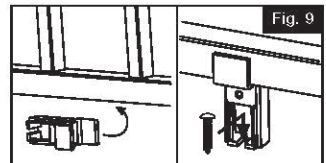

4

Attaching Bottom Rail Bracket Cover:

Test fit the rail panel. Once proper fit is ensured, press bottom bracket covers onto the ends of the bottom rail (Fig. 11) and set panel in place on brackets.

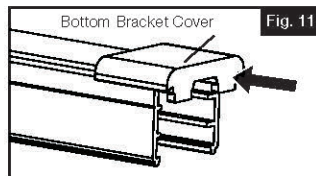

5

Connect Rails to Brackets:

a. Press top rail cap and end covers onto the top rail that was cut in step 1 onto the top of the panel. Press down on the top rail cap to ensure that it fits snug onto the panel and that the top rail end covers are being held in place by the line bracket (Fig. 12).

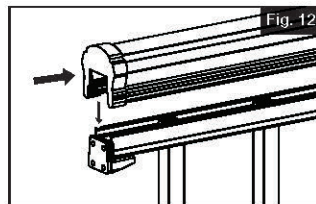

b. Using the holes in the bracket as a guide, pre-drill two (2) 1/8" holes from under the bottom of the rail up through the top rail. Drive two (2) 1 1/2" screws up through the hole locking the bracket, panel and top rail together, being careful not to drill through the top of the top rail (Fig. 13).

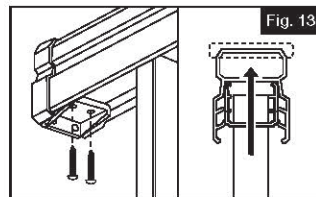

c. Install pyramid post top onto each post (Fig. 14).

NOTE:

A rubber mallet may be needed for a proper fit.

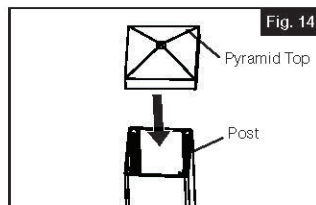

RAIL INSTALLATION - FOR GLASS SLATS

1

a. Slide metal spacer pieces over the end of top and bottom rail channels (Fig. 1).

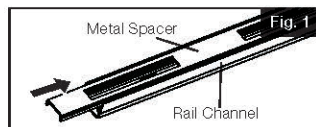

2

Cut Rails to Length (Top & Bottom Rails, Top Rail Cap):

a. Place bottom rail across post opening leaving equivalent spacing from last glass opening to post on each end. Make sure there is even spacing from glass hole to post (Fig. 2)

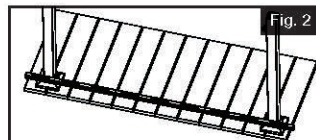

b. Mark rail flush to post.

c. From marked lines, mark additional parallel line 1/4" from first line to allow for bracket clearance (Fig. 3).

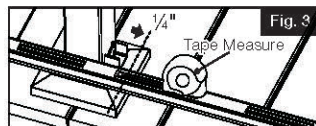

d. Cut rails to length (Fig. 4).

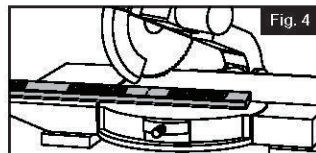

6

3**Install Support Block:**

Pivot support block in place under the rail (Fig. 5).

NOTE:

If using a section longer than 6', use two (2) support blocks (included with 8' panels) and distribute evenly across length of panel. Secure support block(s) to the mounting surface using 1½" screw(s) provided and press cover into place using plastic plug(s) (Fig. 6).

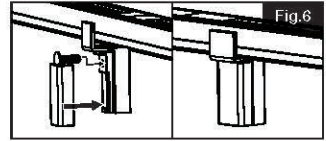
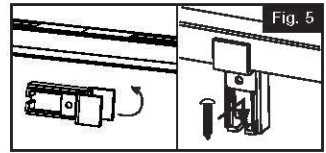
**4****Attaching Bottom Rail Bracket Cover:**

Test fit the rail panel. Once proper fit is ensured, press bottom bracket covers onto the ends of the bottom rail (Fig. 7) and set panel in place onto brackets previously mounted on posts.

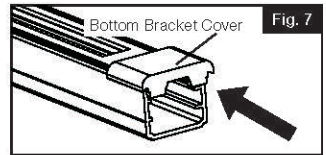
**5****Connect Rails to Brackets:**

- a. Press top rail cap and end covers onto the top rail that was cut in step 1 onto the top of the panel. Press down on the top rail cap to ensure that it fits snug onto the panel and that the top rail end covers are being held in place by the line bracket (Fig. 8).
- b. Using the holes in the bracket as a guide, pre-drill two (2) ¼" holes from under the bottom of the rail up through the top rail. Drive two (2) 1½" screws up through the hole locking the bracket, panel and top rail together, being careful not to drill through the top of the top rail (Fig. 9).
- c. Install pyramid post top onto each post (Fig. 10).

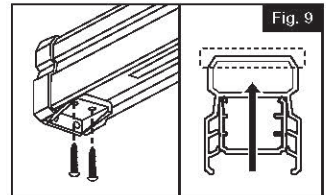
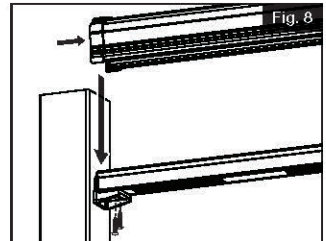
**NOTE:**

A rubber mallet may be needed for a proper fit.

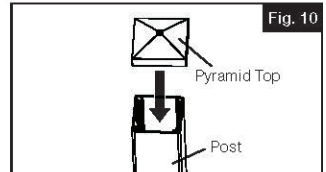
**6****Install The Glass Slats:**

- a. Snap gaskets into bottom rail slots (Fig. 11).
- b. Slide top gasket over the glass slat (Fig. 12.) and place glass slat into top rail. Position glass slat to allow them to "drop into" the bottom rail gasket.
- c. Slide top rail gasket up into top rail ensuring a snug fit (Fig. 12).
- d. Repeat for all other slats.

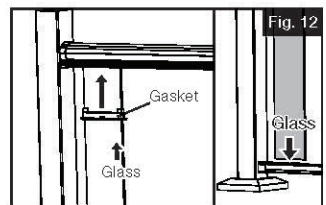
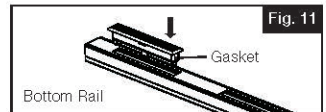

STAIR RAIL INSTALLATION

1 Assemble rail panels as described in "Rail Installation."

NOTE:

- Do not install glass slats on stair railings, only use square or twisted balusters.
- Taller posts (sold separately) may be needed for either bottom or top of the stairs, depending on the angle of the stairway or the location of where the posts will be installed relative to the nose of the stair tread. Bottom stair posts may also be moved out from bottom step (Fig. 1).

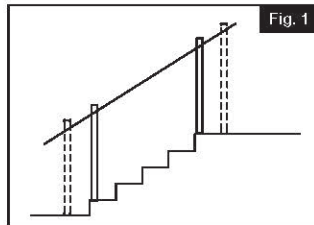

See "Post Installation" section for "Deck/Wood Surface Installations."

2 Place a deck board on the stair noses spanning from post to post. Place the stair panel on the board across the opening and plumb balusters while ensuring equal spacing on each end. Clamp the panel in place at this location (Fig. 2).

NOTE:

Use the proper deck board thickness to result in the desired finished rail height.

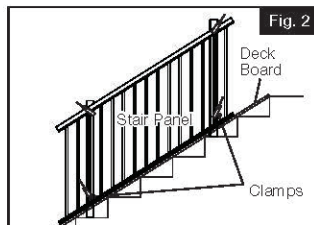

3 Temporarily assemble top and bottom stair mounting brackets. Brackets slide into bracket bases, bracket cover is aligned, and the bracket is fastened together using the hinge bolt provided (Fig. 3 & 4).

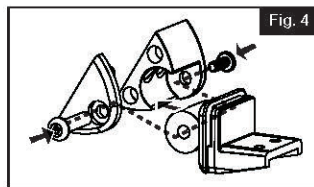
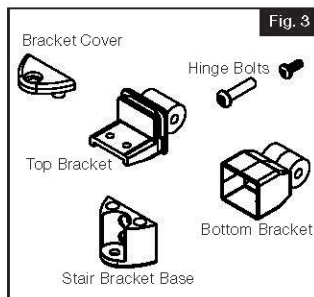

4 a. Hold each respective bracket (angled) against the post face, align bracket with stair panel and mark all four (4) ends of the rail panel (Fig. 5).

b. Repeat this on the opposite side of the panel and be sure to label the top rail to simplify placement after cutting.

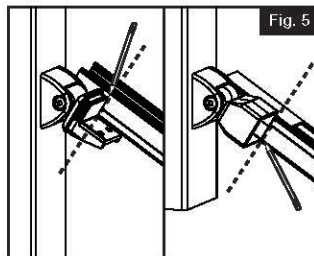

5

- For the bottom rail only, add $\frac{3}{4}$ " (toward the rail end or post) to the marks made on the panel in step 3 (Fig. 6) and cut the panel at these marks.
- For the top rail, cut the panel directly on the marks made in step 3. Insert the bottom brackets onto bottom rail, align top brackets (temporarily secure brackets in place with tape), and test the panel for proper fit.
- Once proper fit is ensured, mark the bracket positions at all four (4) locations (Fig. 7) and remove brackets from the rail panel.

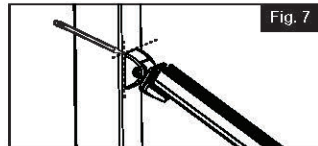
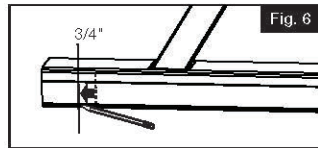
**6**

- Loosely assemble the stair bracket base and cover and use it as a template to mark locations for pre-drilling.

NOTE:

If base is centered without bracket cover, rail will NOT be centered.

- Place the stair bracket base on the post aligned with the marks made in step 5 (Fig. 7) ensuring that brackets are properly oriented.
- Mark the two hole locations shown (Fig. 8) for each bracket and pre-drill using a $\frac{1}{8}$ " bit.
- Secure brackets to post using the non-painted flat head $1\frac{1}{2}$ " screws provided

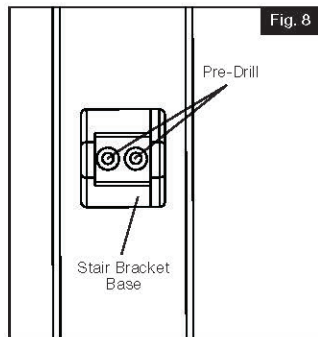
**7**

- Measure the length of the rail panel and cut the top rail (sold separately) to match. Press down on the top rail to ensure that it fits snugly onto the panel (Fig. 9).
- Align top stair bracket with the rail end only at the top of the stairs (Fig. 9). Using the pre-drilled holes as a guide, drill through the railing using a $\frac{1}{8}$ " drill bit being careful not to drill through the top of top rail. Do this for the top of the stairs only (Fig. 10).

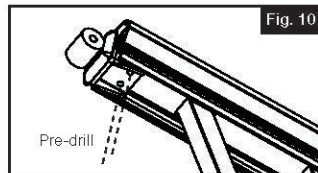
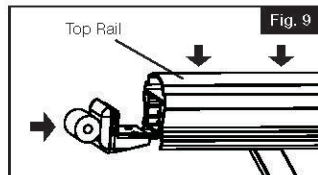
**8**

- Press top rail cap and end covers onto both ends of the top rail. Slide top brackets in place on the rail ends, ensuring that the top rail cap and covers nest into the grooves of the brackets (Fig. 11).
- Align the bracket, panel and top rail. Drive two (2) $1\frac{1}{2}$ " painted pan head screws through the pre-drilled holes locking the assembly together at the top of the stair rail only.

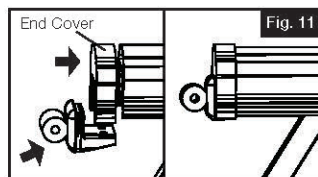

9

- a. Press bottom brackets onto the bottom rails. Slide all four (4) brackets into bracket bases which are connected to the posts.
- b. Slide bracket covers onto the bases and loosely secure in place with provided hinge bolts (Fig. 12).

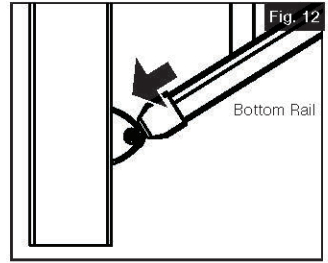
**10**

- a. Pre-drill the top rail at the bottom stair post using the bracket holes as a guide (Fig. 13).
- b. Drive two (2) 1½" painted pan head screws up through the holes locking the bracket, panel and top rail together. Once the top rail is secured, tighten all four (4) of the hinge bolts to lock stair panels in place.

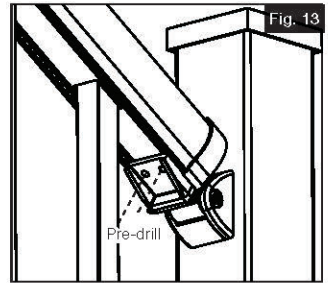
**11**

Install pyramid post top onto each post (Fig. 14).

NOTE:

A rubber mallet may be needed for a proper fit.

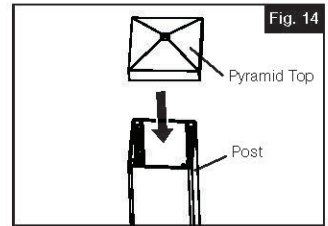

ANGLE RAIL INSTALLATION

NOTE:

Angle rail installation uses a combination of features used in both the rail and stair applications. This installation will use the same bracket base of the stair brackets and similar components, while using the preset layout of the installation template for quick and easy installation.

1

Angle rail brackets must be purchased separately. Angle rail mounting varies greatly on each installation.

10

2

- Cut out bracket template from side of post box. Refer to angle bracket components (Fig. 1).
- Align bottom of template with top of the base trim and secure in place with a piece of tape.
- Follow instructions on template for pre-drilling using a $\frac{1}{8}$ " drill bit, then remove the template.
- Align top and bottom bracket bases with covers attached (Fig. 2) with the holes ensuring that they are square. Fasten bracket bases in place using the non-painted flat head $1\frac{1}{2}$ " screws provided.

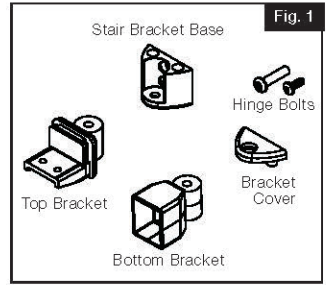
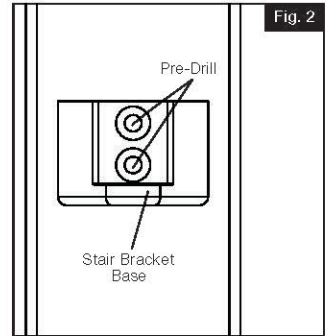
**Fig. 1****Fig. 2****3**

- Temporarily assemble top and bottom level angle brackets. Mounting brackets slide into bracket base, bracket cover is aligned, and the bracket is fastened together using the hinge bolt provided (Fig. 3).
- Align panel on desired angle and mark the top rails (Fig. 4) and bottom rails (Fig. 5).
- Repeat this on the other side of the panel. Label the top of the rail panel to simplify installation.

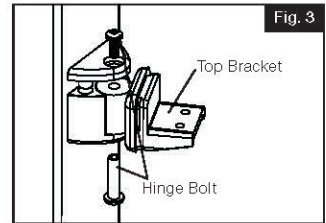
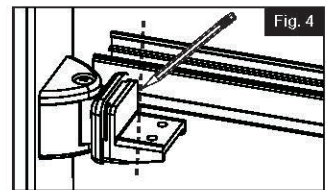
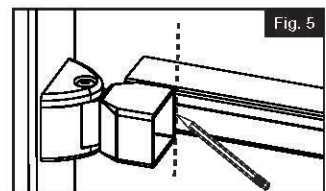
**Fig. 3****Fig. 4****Fig. 5**

4

- For the bottom rail only, add $\frac{3}{4}$ " (toward the rail end or post (Fig. 6) to the marks made on the panel in step 3 (Fig. 5) and cut the panel at these marks.
- For the top rail, cut the panel directly on the marks made in Step 3 (Fig. 4).
- Cut the top rail to the same length.

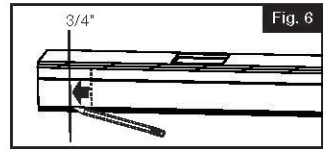

5

Assemble Railing Section:

- Place top and bottom rail on a smooth, flat and clean surface. Then, align the top and bottom rails so that the ridges inside the rails are oriented on the same side (Fig. 7).

NOTE:

There are two (2) ridges on both sides that are different sizes.

- Insert all balusters through the square holes in rails, making sure the hole in each baluster goes in the same direction facing the side with the two (2) small ridges (Fig. 8).
- Make sure the balusters in the rails are about 2" above the rail and in-line with each other (Fig. 8).
- Snap in bumps from locking strip into holes of the baluster for both top and bottom rails. Make sure arrows on locking strip face rails (Fig. 9).
- If the rails were cut shorter in step 3, then there will be some extra locking strip at the end of install. Use scissors or a utility knife to trim off the excess, while leaving approximately 2" after the last engaged bump.
- Pull the top and bottom rails towards ends, guiding the rails over the locking strips until snug.

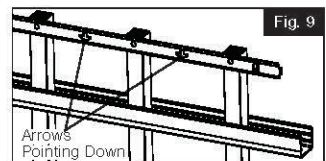
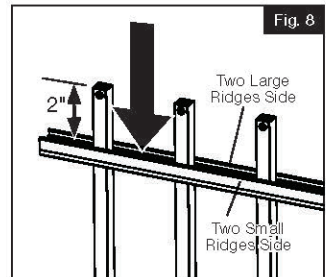
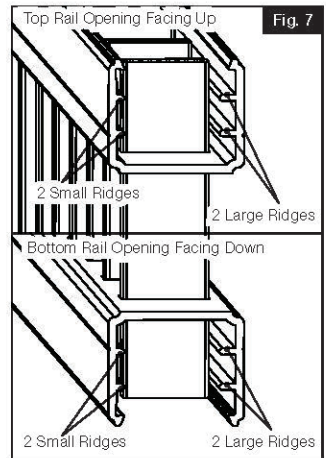

- g. Stand rail section up and fully lock balusters into the rails. Place one foot on the top of the bottom rail, between the second and third baluster while at the same time placing a hand under the bottom of the top rail between the second and third baluster. Push with foot and pull with hand until locking is completed. You should hear a snap as the strip locks into the rail. Repeat this process for the middle and the end of the panel (Fig. 10).

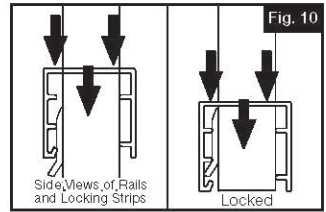

NOTE:

If no snap is heard or felt, use a rubber mallet to tap underneath of top rail to ensure a full connection

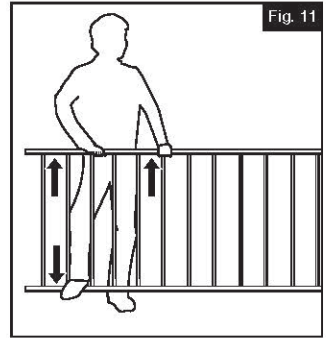

6 Install Support Block:

Pivot support block in place under the rail (Fig. 12).

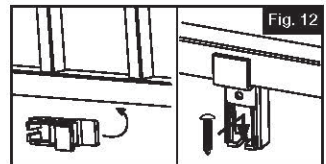

NOTE:

If using a section longer than 6', use two (2) support blocks (included with 8' panels) and distribute evenly across length of panel. Secure support block(s) to the mounting surface using 1½" screw(s) provided and press cover into place using plastic plug(s) (Fig. 13).

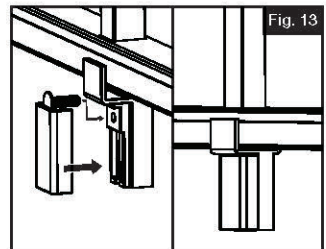

- 7** a. Remove the hinge bolts from the bottom brackets. Remove the bottom brackets from the bracket bases, and insert the bottom brackets into each end of the bottom rail (Fig. 14).

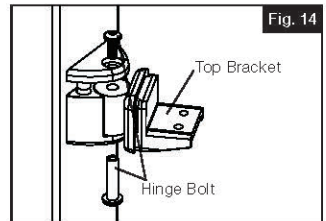

- b. Slide the bottom bracket (and rail) into the bottom mounting base while setting the top rail on top of the top rail bracket.

- c. Reinsert the hinge bolt through the bottom brackets to lock assembly into place.

Connect Rails to Brackets:

- Press top rail bracket end covers onto each end of the top rail cap that was previously cut. Press down on the top rail cap to ensure that it fits snug onto the panel and that the top rail end bracket covers are being held in place by the line bracket (Fig. 15).
- Using the holes in the bracket as a guide, pre-drill two (2) $\frac{1}{8}$ " holes from under the bottom of the rail up through the top rail. Drive two (2) $1\frac{1}{2}$ " screws up through the hole locking the bracket, panel and top rail together, being careful not to drill through the top of the top rail (Fig. 16).
- Install pyramid post top onto each post (Fig.17).

NOTE:

A rubber mallet may be needed for a proper fit.

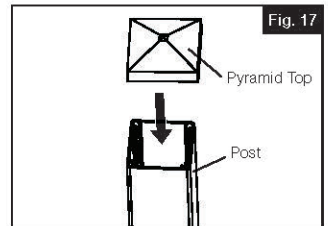
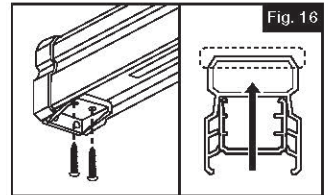
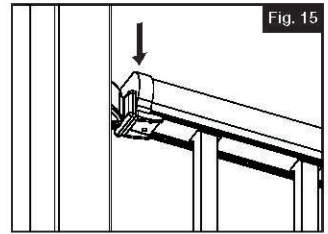

Transferable Limited Lifetime Warranty

What is covered: Barrette Outdoor Living warrants vinyl and aluminum products to include; vinyl and aluminum fence, vinyl and aluminum railing and plastic lattice against defects or workmanship for as long as you own your home. Barrette Outdoor Living will at its option replace the product in question with new product of the same or equivalent value at no charge. Barrette Outdoor Living warrants these products against peeling, flaking, splintering, corrosion, rusting or abnormal discoloration under normal use and service per ASTM D 2244. This warranty extends to the original purchaser or transferee as specified herein on the products noted above. Separate and distinct warranties for hardware and other products are not covered under this warranty.

What this warranty does not cover: This limited warranty does not cover damage resulting from accident, unreasonable use, neglect, alteration, improper service, improper installation, acts of God or any other causes not arising out of defects in materials or workmanship. Additionally, this warranty does not cover costs of installation, removal, reinstallation or surface mold and mildew created by excessive environmental conditions. Any service or repair provided outside the scope of this limited warranty shall be at Barrette Outdoor Living's rate and terms then in effect.

What do we do to correct the problems? Should your Barrette Outdoor Living product prove defective under warranty, reference the website or call the phone number listed below. Your problem will be assigned a tracking number and an authorized Barrette Outdoor Living representative will contact you to arrange a convenient time to schedule an onsite inspection, or request pictures, if need be. If after inspection product is deemed to be manufacturer defect we will make arrangements to rectify the issue. You must have proof of your purchase in order for the problem to be corrected.

Transferee Coverage: Warranty coverage will be extended to one transferee on the above listed products with the following limitations. Transferee must obtain an original or copy of the initial sales receipt (with proof of date) from the previous owner(s). Additionally, if fence is purchased from a builder or installer, documentation must be supplied that names the product installed on property and date of transfer.

THIS WARRANTY IS IN LIEU OF ALL CONDITIONS OR WARRANTIES, EXPRESS OR IMPLIED, INCLUDING BUT NOT LIMITED TO ANY IMPLIED CONDITIONS OR WARRANTIES OR MERCHANTABILITY OR FITNESS FOR A PARTICULAR PURPOSE ON THE PART OF BARRETTE OR ITS LICENSORS, SOME STATES DO NOT ALLOW THE EXCLUSIONS OF IMPLIED WARRANTIES OR LIMITATIONS OF HOW LONG AN IMPLIED WARRANTY LASTS, SO THE ABOVE LIMITATIONS MAY NOT APPLY TO YOU. IF THE PRODUCT IS DEFECTIVE PER THE ABOVE COVERAGES, YOUR SOLE AND EXCLUSIVE REMEDY SHALL BE REPAIR OR REPLACEMENT AS PROVIDED ABOVE. BARRETTE AND ITS LICENSORS SHALL NOT BE LIABLE FOR ANY DAMAGES, LOSS OF USE, LOSS OF PROFITS OR INTERRUPTION OF BUSINESS WHETHER SUCH ALLEGED DAMAGES ARE BASED IN WARRANTY, TORT, CONTRACT, OR INDEMNITY. SOME STATES DO NOT ALLOW THE EXCLUSION OF LIMITATIONS OF INCIDENTAL OR CONSEQUENTIAL DAMAGES, SO THE ABOVE LIMITATIONS MAY NOT APPLY TO YOU. THIS WARRANTY IS VALID ONLY IN THE UNITED STATES AND CANADA.

For any specific questions about the Barrette Outdoor Living Warranty please contact Barrette Outdoor Living by visiting our website www.barretteoutdoorliving.com, emailing or calling 1-800-336-2383.

To begin your warranty coverage and register your product visit: www.barretteoutdoorliving.com. Retain manual and your dated sales slip for future reference or warranty claims.

BARRETTE OUTDOOR LIVING

7830 FREEWAY CIRCLE
MIDDLEBURG HEIGHTS, OHIO 44130

TEL: (800) 336-2383
WWW.FREEDOM.BARRETTEOUTDOORLIVING.COM

