

# WoodHaven™

CEILING PLANKS



5" x 84" x 3/8"  
127 mm x 1981 mm x 10 mm

10<sub>planks</sub> 29<sub>sq. ft.</sub>



- **Natural, wood-grain look**  
Eleven beautiful colors to choose from
- **Prefinished, durable laminate surface**  
Excellent resistance to surface impact
- **Superior humidity and sag resistance**  
Ideal for any room — even kitchens and baths
- **Maintenance free**  
Cleans with a damp cloth
- **Easy installation**  
Interlocking tongue-and-groove planks
- **Wainscoting**  
Installs easily on walls\*
- **10 year limited warranty**

\* Only 1148 WoodHaven Painted White and 1149 Beadboard recommended for wainscot.



**Simple Clip Installation  
System Included In  
Every Package!**

Inspiring Great Spaces™

**Armstrong®**

## WoodHaven™ Ceiling Plank Installation Instructions

WoodHaven planks can be directly attached to existing ceiling joists (joists must be no more than 24" on center), drywall or plaster ceilings using the clips included in every package. WoodHaven can also be suspended with a standard 15/16" grid system using Easy Up® clips.

If the following special circumstances exist you should utilize the Armstrong Easy Up Guaranteed Installation System. Refer to the instructions below for installing WoodHaven Planks with Easy Up®. Easy Up tracks and clips sold separately.

- You need to even out your existing ceiling's substrate: Easy Up allows you to shim the system to create a flatter surface.
- You have an area of high humidity: Easy Up track allows a small space above the planks for air circulation. Or a 15/16th suspension system with Easy Up clips will also provide the gap for air circulation.
- You need access to systems above your plank ceiling: Easy Up clips used to install planks on a 15/16th suspension system or Easy Up Track allow for easy access to pipes, ducts, and wiring above.
- You need to lower your existing ceiling: Easy up clips used to install planks on a 15/16th suspension system allow you to lower your ceiling.

### Before you begin:

- Remove ceiling planks from cartons 24 hours before installation and allow to adjust to normal interior conditions of the installation area.
- Do not apply loose fill or batt insulation so it comes in direct contact with the back of the plank.
- Do not install ceiling planks below imbedded radiant-heat coils.
- Plan for lighting or other fixtures that may be included in your room. Mount electrical boxes so they are 3/8" lower than the surface you will attach the plank to. Use light fixtures that will not raise the temperature of the planks above 230 degrees Fahrenheit to prevent discoloration of the plank. Contact the light manufacturer for any questions about the amount of heat generated by the light.

### SAFETY:

- ⚠ Caution:** Wood Dust. Sawing, sanding and machining wood products can produce dust. Airborne wood dust can cause respiratory, eye and skin irritation. The International Agency for Research on Cancer (IARC) has classified wood dust as a nasal carcinogen in humans.
- Establish and maintain adequate ventilation in the work area. Use an appropriate NIOSH-designated dust respirator. All power cutting tools must be equipped with dust collectors.
- Wear long-sleeve, loose fitting clothing and gloves.
- Persons who are sensitive to odor and/or chemicals should avoid the work area during this process.
- Wear safety glasses to minimize the risk of eye injury.
- Store cutting equipment properly when not in use.
- Follow manufacturer's instructions when working with adhesives for beaded plank installation. Armstrong does guarantee the performance of adhesives.

### Maintenance Hints:

- Wipe with a damp cloth.

### Tools & Materials You May Need:

**Note: Be sure to follow the manufacturer's recommendations when using power tools.**

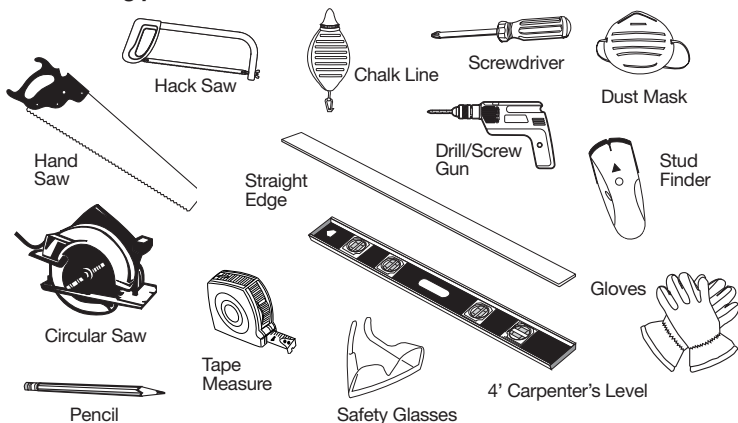

## Installing WoodHaven™ Planks Directly To Ceiling Joists:

Locate ceiling joists if not exposed. Tap on the plaster or drywall ceiling until you hear a solid thud, or use a stud finder. Generally, joists are spaced 16" or 24" on center.

### Determine border plank size for a balanced appearance:

	Example:	Your Room:
1. Measure room width same direction as the joists	Room = 178"	_____
2. Divide by 5"		_____
3. Multiply the remainder by 5"	$178 \div 5 = 35.6$	_____
4. Add 5" to the result	$0.6 \times 5 = 3"$	_____
5. Divide result by 2	$3 + 5 = 8"$	_____
6. Record your border plank width	$8 \div 2 = 4"$	_____
	Border plank width = 4"	_____

### Install Planks

#### Snap a Chalk Line

- Measure the calculated border plank width and snap a chalk line at that distance from the front wall.

illus. A

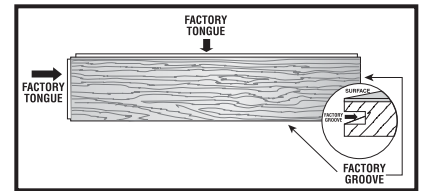

#### Cut First Border Plank

- Familiarize yourself with the plank edges and face before you begin cutting your first plank. (illus. A)
- Cut the first row of plank to the border plank width, removing the tongue edge.
- Each plank for the first row will be cut to the border plank width minus 1/2".

#### Install First Row of Planks

- Align the groove edge of the border plank with the chalk line. (illus. B)
- Slide clips into the groove at the joists and screw clips to the underside of the joists. Ensure screws are installed straight into joists. If installed at an angle the screw head could interfere with installation.

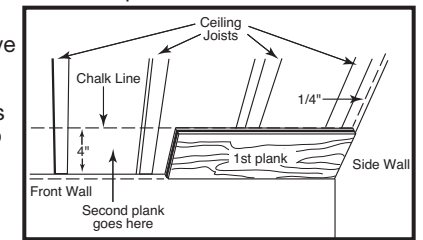

illus. B

- Face nail or screw to the joists along the cut edge. Be sure to nail or screw close enough to the front wall so molding will cover the nails or screws.

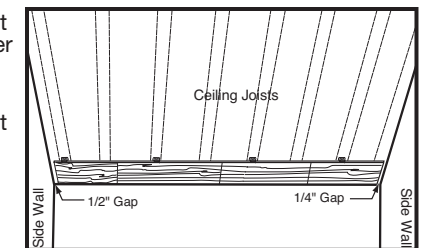

illus. C

- Continue measuring, cutting and installing first row of planks. Cut last plank to the length that leaves a 1/2" gap at the opposite side wall. (illus. C)

### Instructions if installing item 1149 Beadboard:

Plank ends meet with a shiplap joint. When you install the second plank with the shiplap joint facing up (illus. D) apply a small amount of water-based wood glue to the joint. Any material expansion due to room conditions will take place at the ends of each course of plank.

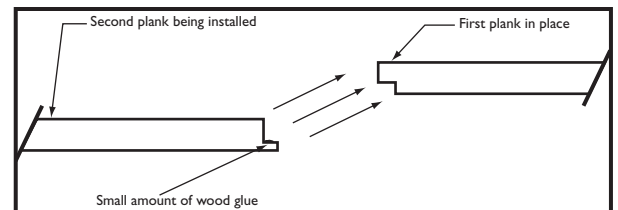

illus. D

### Install Remaining Planks

1. Seams from row to row should be staggered. Cut some length from the first plank of the second row to stagger the seams from row to row.
2. Start the second row by inserting the tongue into the groove of the piece in the first row. (illus. E)
3. To maintain staggered seams from row to row, the remaining rows can start with the remaining piece of plank cut from the last plank of each prior row.
4. Measure and cut the width of the last row of planks 1/2" short of the end wall.
5. Install last row of planks into previous row and face nail or screw to joist along the cut edge. Be sure to nail or screw close enough to the end wall so molding will cover the nails or screws.

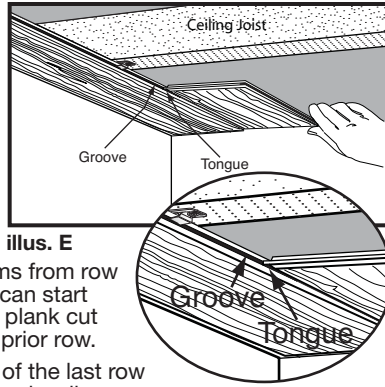

illus. E

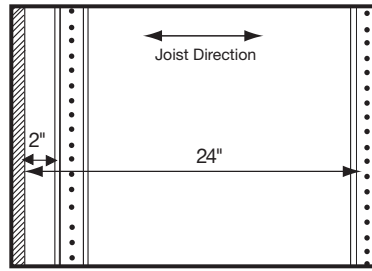

illus. H

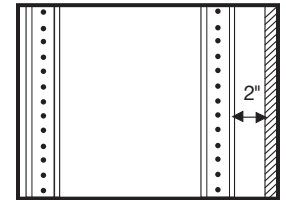

illus. I

### Install Molding

1. Choose molding wide enough to cover the expansion gap and face nail on the plank edge.
2. Paint or stain decorative molding before installing.
3. Install molding at the joint between the ceiling and walls.
4. Nail molding into the wall studs at least every 24". (illus. F)

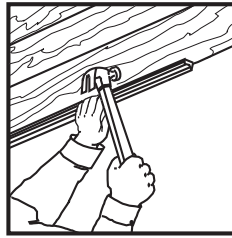

illus. F

### Cut First Border Plank:

1. Familiarize yourself with the plank edges and face before you begin cutting your first plank. (illus. J)
2. Cut first plank to the calculated border plank width. Measure and mark the face of the plank from the groove edge and cut plank to the border plank width, removing the tongue edge.
3. Each plank in the first row will be cut to the calculated border plank width.

illus. J

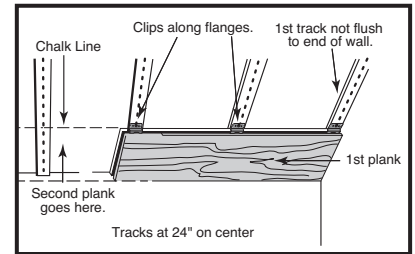
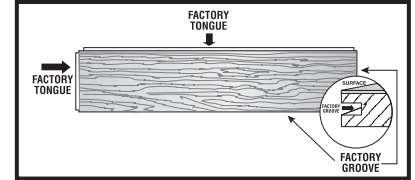

illus. K

### Install First Row of Planks (illus. K)

1. Starting 1/4" from the side wall, align the groove edge of the plank with the chalk line.
2. Face nail or screw through track to joist along the cut edge. Be sure to nail or screw close enough to the end wall so molding will cover the nails or screws.
3. Snap clips on each track and slide them into the groove side of the plank.
4. Continue measuring, cutting and installing first row of planks. Cut last plank to the length that leaves a 1/2" gap at the opposite wall. (illus. L)

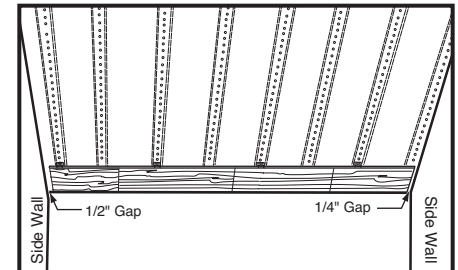

illus. L

## Installing WoodHaven™ Planks with Easy Up®:

Locate ceiling joists. Tap on the plaster or drywall ceiling until you hear a solid thud, or use a stud finder. Generally, joists are spaced 16" or 24" on center.

### Determine border plank size for a balanced appearance:

	Example:	Your Room:
1. Measure room width in the opposite direction as the joists	Room = 178"	_____
2. Divide by 5"	$178" \div 5" = 35.6$	_____
3. Multiply the remainder by 5"	$0.6 \times 5" = 3"$	_____
4. Add 5" to the result	$3" + 5" = 8"$	_____
5. Divide result by 2	$8" \div 2 = 4"$	_____
6. Record your border plank width	Border plank width = 4"	_____

### Install Track

1. Run Easy Up track opposite the direction of the joists. Install track with #6 coarse thread screws. Screw length may vary, depending on your existing ceiling type. Over plaster - 3" screw; over drywall - 2" screw; direct to joists - 1 5/8" screw.

**NOTE: If necessary, you can shim Easy Up tracks to improve the flatness of your existing ceiling.**

2. Screw first row of track 2" from the side wall. Use a screw at every joist. Continue installing first row of track end-to-end or overlapped side to side. (illus. G)

Track should be installed flush to the front and back walls. To finish a row of track, cut to fit using tin snips or a hacksaw.

3. Install remaining rows 24" on center. (illus. H)
4. Install the last track row 2" from the opposite side wall. (illus. I)

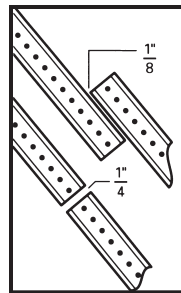

illus. G

### Snap a Chalk Line:

1. Snap a chalk line at the border tile width from the front wall across the Easy Up Tracks.

### Instructions if installing item 1149 Beadboard:

Plank ends meet with a shiplap joint. When you install the second plank with the shiplap joint facing up (illus. M) apply a small amount of water-based wood glue to the joint. Any material expansion due to room conditions will take place at the ends of each course of plank.

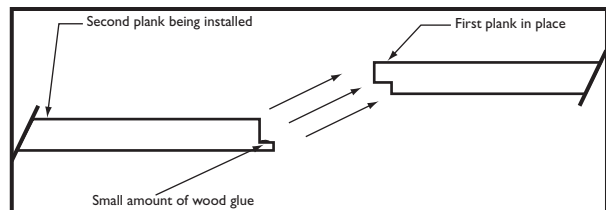

illus. M

### Install Remaining Planks

1. Seams from row to row should be staggered. Cut some length from the first plank of the second row to stagger the seams from row to row.
2. Start the second row by inserting the tongue into the groove of the piece in the first row. (illus. N)
3. To maintain staggered seams from row to row, the remaining rows can start with the remaining piece of plank cut from the last plank of each prior row.

- Measure and cut the width of the last row of planks  $\frac{1}{2}$ " short of the end wall.
- Install last row of planks into previous row and face nail or screw to joint along the cut edge. Be sure to nail or screw close enough to the end wall so molding will cover the nails or screws.

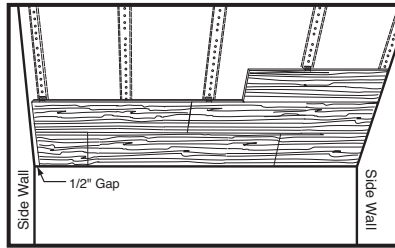

illus. N

#### INSTALL MOLDING

- Choose molding wide enough to cover the expansion gap and face nail on the plank edge.
- Paint or stain decorative molding before installing.
- Install molding at the joint between the ceiling and walls.
- Nail molding into the wall studs at least every 24". (illus. O)

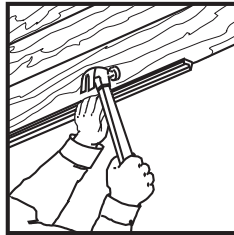

illus. O

### Installing WoodHaven™ Planks on a 15/16" Suspension System with Easy Up® Clips:

#### Important:

- Do not install WoodHaven planks over an existing acoustical tile ceiling. If you are updating an existing 15/16th suspension system be sure to remove the ceiling panels prior to installing WoodHaven planks.
- If you need instructions for installing a new Armstrong Prelude 15/16" suspension system please visit [www.armstrong.com](http://www.armstrong.com).
- Clips included in the WoodHaven packaging will only be utilized when a plank's leading edge lands on or near a parallel grid piece. See tip below.
- Easy Up clips are sold separately.

#### Determine Plank Direction

- Install planks perpendicular to the cross tees, parallel to the main beams on a 2'x4' grid system.
- Install planks perpendicular to or parallel with the cross tees on a 2'x2' grid system.

**Note:** To change plank direction, a 2'x4' system can be converted to a 2'x2' system by adding 2' cross tees.

Tip: If a plank's leading edge lands on or near a parallel grid piece, the Easy Up clips will not line up correctly with the plank. Use a WoodHaven clip provided with the plank packaging to screw the clip directly to the grid.

Tip: When starting or ending a WoodHaven Plank installation on 15/16" suspension system, screw the plank directly to the wall molding in lieu of joists.

Please use the "Installing WoodHaven Planks with Easy Up" instructions found on the previous page to install WoodHaven Planks on a 15/16" suspension system. (Note: Skip Install Track section)

### WoodHaven™ Wainscoting and Backsplash Installation Instructions

WoodHaven Painted White (1148) and Beadboard (1149) planks can also be used as a wainscoting or backsplash.

Before you start, unpack the planks in the room they will be installed 24 hours prior to adapt to the temperature.

#### Tools:

Hand saw, circular saw (optional), saber saw (optional), measuring tape, chalk line, cordless or hand screwdriver and pencil. When using power tools, be sure to follow the manufacturer's recommendations for their use.

For WoodHaven wainscoting, the maximum wall height to be covered is 42". To prevent wet floors from damaging the planks, install a piece of 3/8" thick lath on the wall at the floor so the bottom of the planks can butt against the top of the lath.

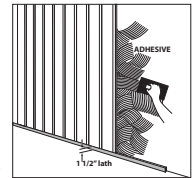

While the traditional orientation of wainscoting is vertical, the WoodHaven planks can be installed on walls either vertically or horizontally.

When installing the planks vertically, you should use a construction adhesive to secure the planks to the wall. Be sure to check that the adhesive is suitable for the wall surface you are adhering to. Follow the adhesive manufacturer's recommendations for surface preparation and application rate. If the planks do not stick to the wall immediately, use painter's tape to hold the planks to the wall until the adhesive sets up.

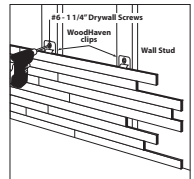

Planks can also be installed horizontally. When installing horizontally, you will use the WoodHaven clips enclosed in the WoodHaven carton. With the long tongue edge of the first plank resting on the lath, you place the clip over the flange at a stud location. Using #6 x 1-1/4" drywall screws sold separately (do not use the enclosed screws, they are too short for this application), secure the clip to a wall stud. Fasten clips at every stud location along the plank being installed.

For wainscoting, apply a baseboard of your choice over the bottom of the planks covering the lath and the bottom of the planks. A top trim of your choice can be installed at the top of the planks to serve as a chair rail and finish the installation.

#### Maintenance Hints:

Clean with a damp cloth.

### WoodHaven Ceiling Planks Come With A 10 Year Limited Warranty

For additional information and videos about installing ceilings, including special installation tips and warranty details, please visit our website at [www.armstrong.com](http://www.armstrong.com) or call 1-800-ARMSTRONG

#### CAUTION: WOOD DUST.

Sawing, sanding and machining wood products can produce dust. Airborne wood dust can cause respiratory, eye and skin irritation. The International Agency for Research on Cancer (IARC) has classified wood dust as a nasal carcinogen in humans.

Assembled for Armstrong World Industries Inc. in the United States of America with components of both domestic and foreign origin.  
LANCASTER, PA 17604

1 800-Armstrong [www.armstrong.com](http://www.armstrong.com)

Printed in United States of America

LA-295529-715

**Armstrong®**

Inspiring Great Spaces™