



Lock and Handle INSTALLATION INSTRUCTIONS

NOTE: Strike plate and key cylinder screw match your door color and are found in the closer kit. Handle style may vary.

Drawings in this instruction show a right hinge installation.

Tools Required

- Phillips screwdriver #2
- Allen wrench (provided)

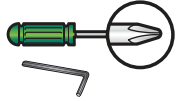

Handle Parts Illustration

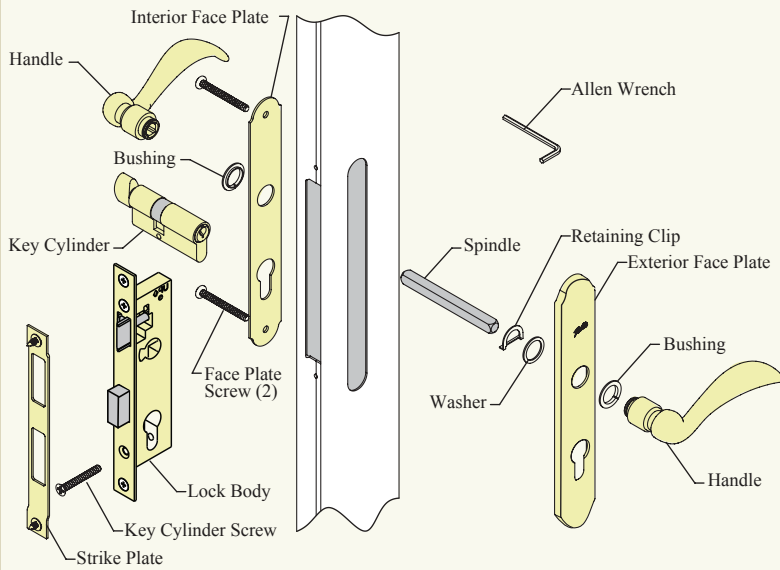

1 Remove lock body from edge of door and remove packaging.

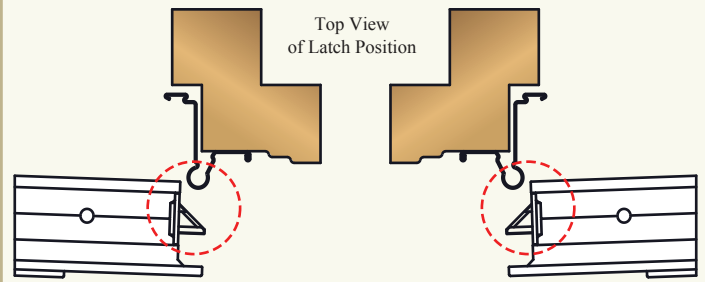

Left Hinge Installation

Right Hinge Installation

2 Right Hinge Installation: go to Step 3.
Left Hinge Installation: change the latch orientation.

- Lift up on locking tab.
- Push latch bolt through the mortise plate.
- Rotate latch bolt 180 degrees.
- Release latch bolt back through the mortise plate.
- Release locking tab and ensure it returns to its original position.

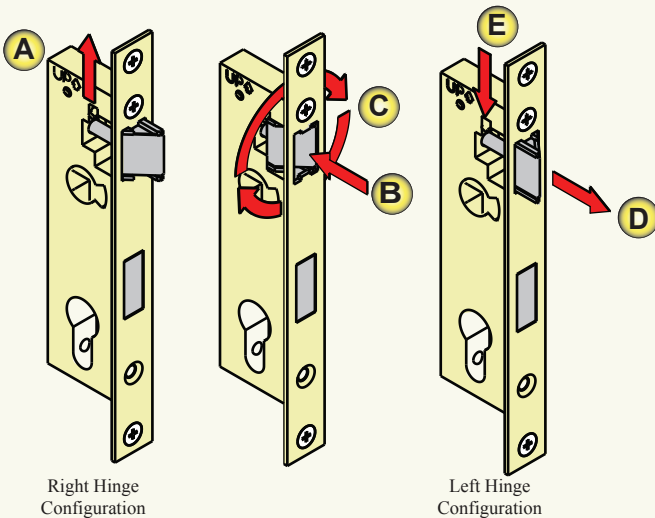

3 Install lock body with attached screws.

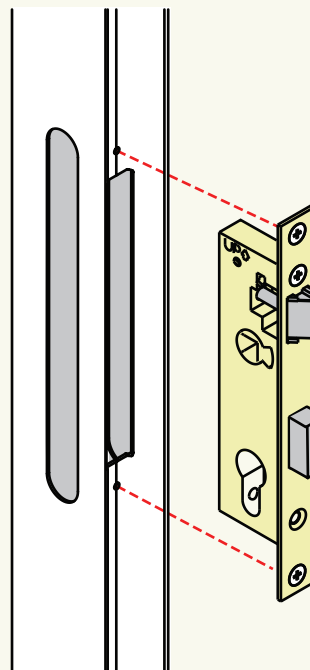

4 Insert key cylinder.

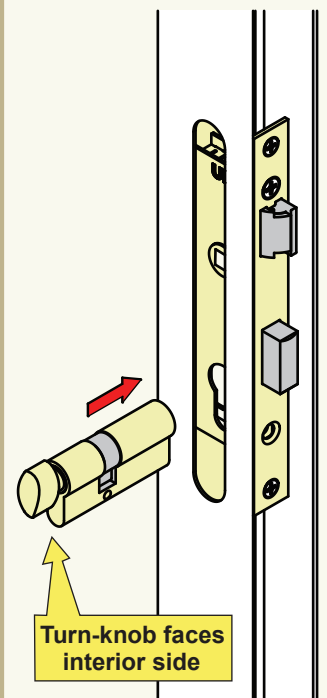

5 Assemble: Exterior handle, black bushing, exterior face plate, and flat washer.

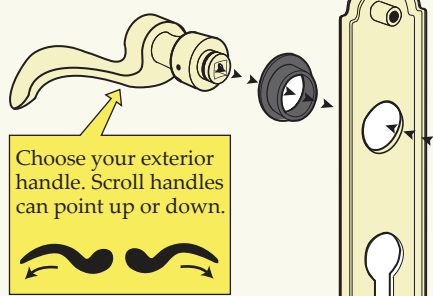

Choose your exterior handle. Scroll handles can point up or down.

Note: Black bushing may be pre-assembled to handle.

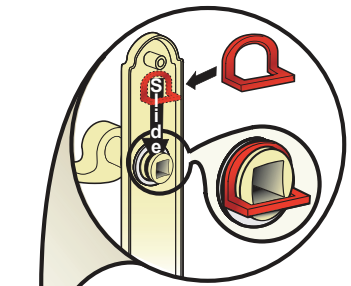

6 Secure with retaining clip.

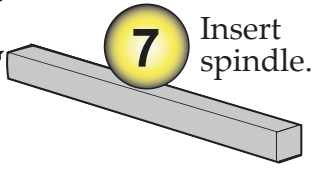

7 Insert spindle.

8 Tighten set screw with provided Allen wrench.

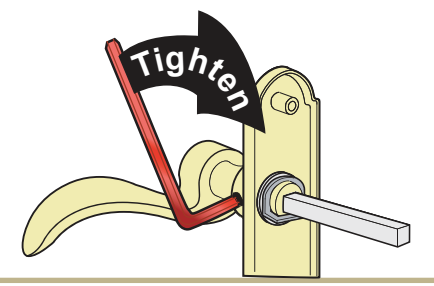

9 Loosely assemble: interior handle, black bushing, interior face plate, and exterior assembly. Install key cylinder screw, found in Bag C in the closer kit.

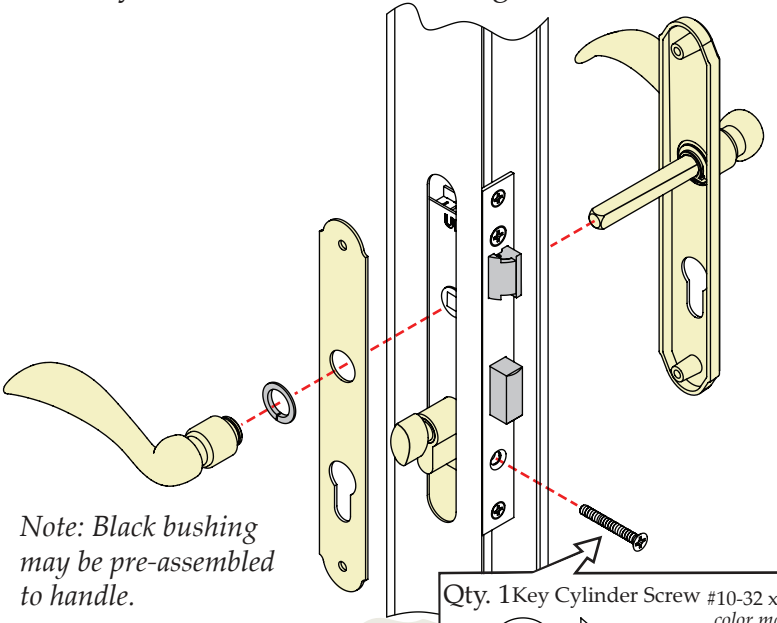

Note: Black bushing may be pre-assembled to handle.

Qty. 1 Key Cylinder Screw #10-32 x 1-1/2" Flat Head color matched to hardware

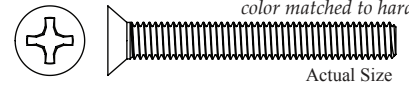

Actual Size

10 Hold handles together and tighten interior set screw. Secure with face plate screws.

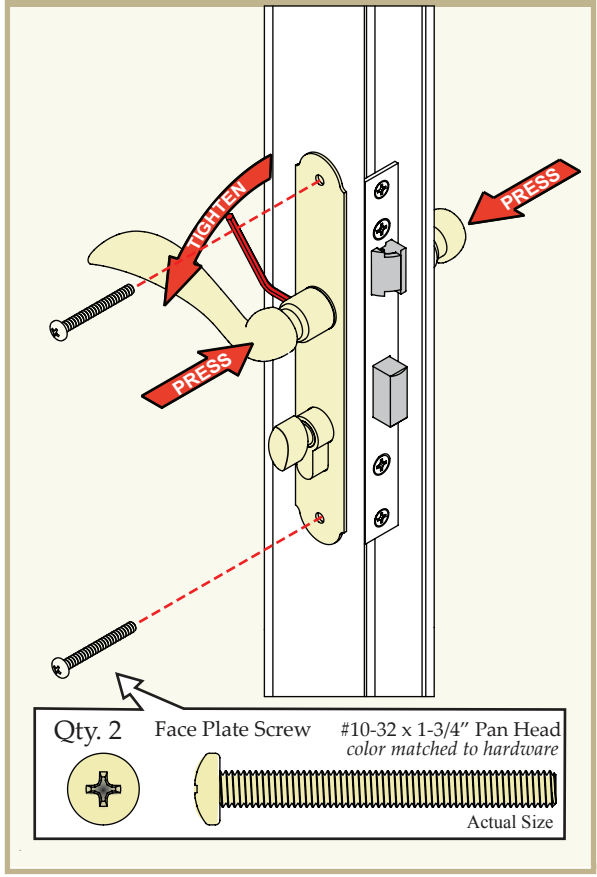

Qty. 2 Face Plate Screw #10-32 x 1-3/4" Pan Head color matched to hardware

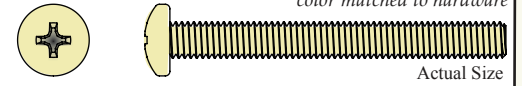

Actual Size

11 Locate strike plate with attached screws in the closer kit. Attach to the latch rail. Adjust if necessary.

Return to your "Owners Manual and Installation Guide" to complete the installation.