

# ASSEMBLING & INSTALLATION INSTRUCTIONS PRODUCT# HAMILTON SERIES OUTDOOR WALL MOUNT LIGHT FIXTURE

**WARNING! SHUT POWER OFF AT FUSE OR CIRCUIT BREAKER .**

## MOUNTING THE FIXTURE

### Installation (see fig.1)

1. Shut off the power at the circuit breaker and remove old fixture, including the cross bar.
2. Carefully unpack new fixture and lay all the parts on a clear surface. Take care not to lose any small parts necessary for installation.
3. Thread the two mounting screws about 1/4" into the pre-drilled holes in the mounting plate, spaced about the same distance apart as the holes in the fixture back plate. Attach the mounting plate to the junction box using two junction box screws. The side of the mounting plate marked "GND" must face out.
4. Follow wiring instructions carefully (see fig.2)
5. Put the candle sleeve(F) over the lamp holder. Attach the finial(H) to bottom screw hole of the lamp body(E) and lock it until tight.
6. Install the light bulbs in accordance with the fixture's specifications. **DO NOT EXCEED THE MAXIMUM WATTAGE RATING!**
7. Attach the back plate of the lamp body(E) onto the junction box, aligning the back plate's hole with mounting screw and lock it securely with the hex nuts(G).
8. Thread nipple of the finial(A) into cover (B) and lock it securely with the hex nut(D). Attach the cover(B) onto the lamp body(E) , aligning the cover's hole with the mounting screw and lock it securely with hex nut(C).
9. **With silicone caulking compound, caulk completely around where back of cover meets with the wall surface to prevent water from seeping into outlet box.**

### Wiring (see fig.2)

1. Connect the electrical wires as follows. Connect the black wire from the fixture to the black house (hot) Wire. Connect the white wire from the fixture to the white (neutral) house wire. Make sure all wire nuts are secured. You may wrap the connections with electrical tape.If your outlet box has a ground wire (green or bare copper) connect fixture's ground wire to it. Otherwise attach the bare copper fixture wire to the green ground screw on the cross bar.
2. Tuck the wire connections neatly into the wall junction box.

Fig.1

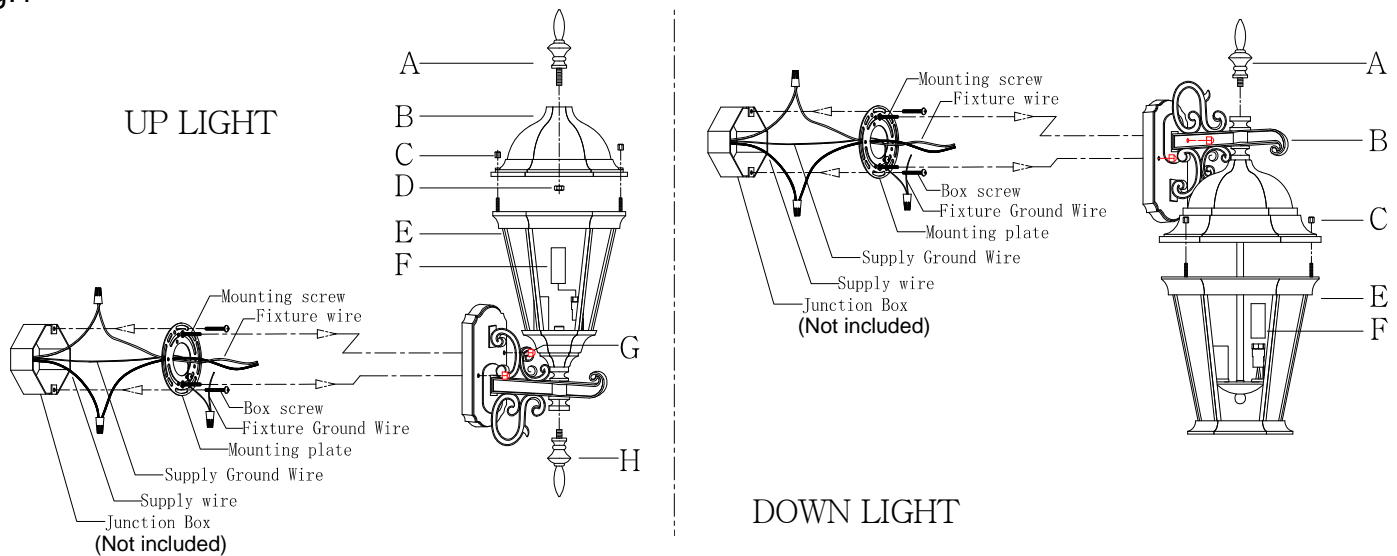







Fig.2

FIXTURE WIRES Black or Smooth		FIXTURE WIRES White or Ribbed		FIXTURE WIRES Bare Copper (Ground)	
HOUSE WIRES Black (Hot)		HOUSE WIRES White (Neutral)		HOUSE WIRES Green or Bare Copper (Ground)	



DOC20141207561