

Please go to www.quoizel.com for product cleaning tips. Go to the **Care + Maintenance** selection.

Tools Required: Flathead screwdriver, Phillips screwdriver, pliers, wire cutters, wire strippers, electrical tape, safety glasses.

Light Source: (6) A19 Medium Base 100W Maximum. Alternate Bulbs (6) 23W CFL.

Estimated Assembly Time: 30-45 minutes

Preparation: Identify and inspect all parts before beginning installation. Check package content list and diagrams below to be sure all parts are present. If any parts are missing or damaged, do not attempt to assemble, install, or operate the fixture. Contact customer service for replacement parts.

⚠ Warnings and Cautions

Turn off electricity at circuit breaker or main fuse box before installation. Consult a licensed electrician if in doubt.

These instructions are provided for your safety. It is very important you read them completely before installing the fixture. We strongly recommend that a licensed, professional electrician perform the installation.

Disconnect fixture from power source before replacing bulbs. Make sure bulbs are given sufficient time to cool before removal. Do not subject glass parts to any shock while in operation or shattering may result.

Package Contents

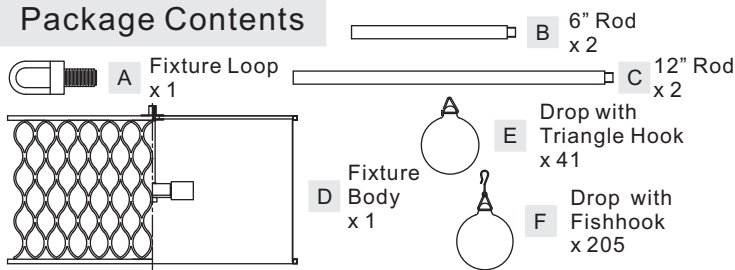

STEP 1 – Attach Drops onto Fixture Loop

- Attach Drop with Triangle Hook (E) to holes on first layer on the Fixture Body (D) properly.
- Attach Drop with Fishhook (F) to holes on other Layers on the Fixture Body (D) properly.

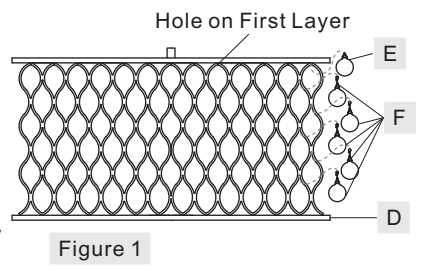

Figure 1

STEP 2 – Assemble the Rods and the Fixture Loop

- Determine the Rods (B/C) to be assembled to the Fixture Body (D) according to your hanging height.
- Pass the supply wires and ground wire through the chosen rods (B/C) and the Fixture Loop (A). Thread the Fixture Body (D), the chosen Rods (B/C) and the Fixture Loop (A) together. Hand tighten until snug.

Suggested rods for Ceiling height :
8' ceiling: use (1) 6" rod and (1) 12" rod
9' ceiling: use (1) 6" rod and (2) 12" rods
10' ceiling: use (2) 6" rods and (2) 12" rods

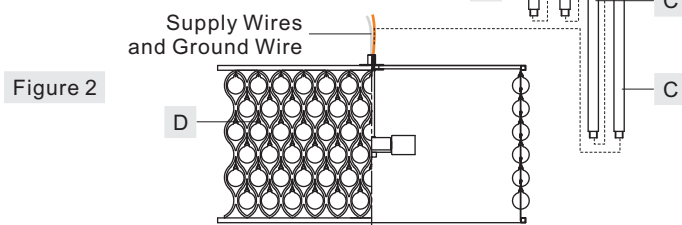
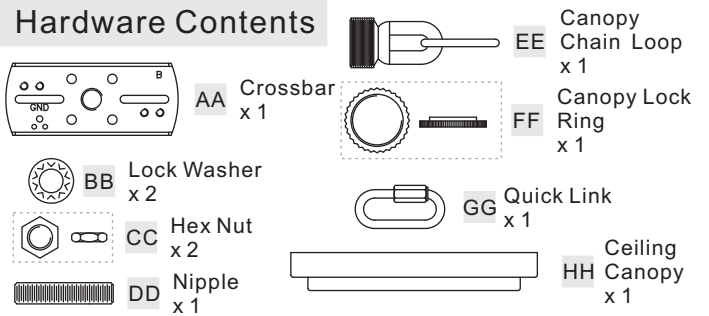

Figure 2

STEP 3 – Install Crossbar

- Attach the Crossbar (AA) to the Outlet Box with the head of the Green Ground Screw facing you. Secure it with Outlet Box Screws (not included). Tighten until snug.

Hardware Contents



Step 3 Continued

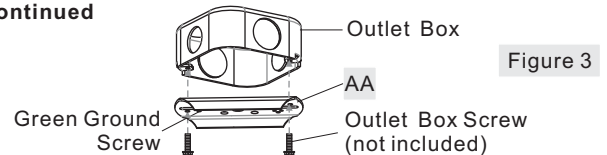

Figure 3

STEP 4 – Install Canopy Chain Loop and Nipple

* Pliers is required for this step.

- Thread one Hex Nut (CC) to one end of the Nipple (DD) until it is at least 0.25" from the end. Pass one Lock Washer (BB) over the end of the Nipple (DD) and thread the Canopy Chain Loop (EE) onto the Nipple (DD). By using pliers, thread the Hex Nut (CC) against the Canopy Chain Loop (EE) and hand tighten until snug.
- Thread another Hex Nut (CC) to the middle of the Nipple (DD). Place another Lock Washer (BB) over the Nipple (DD) and then thread the Nipple (DD) into the Crossbar (AA) until the Nipple (DD) is about 0.375" above the Crossbar (AA).

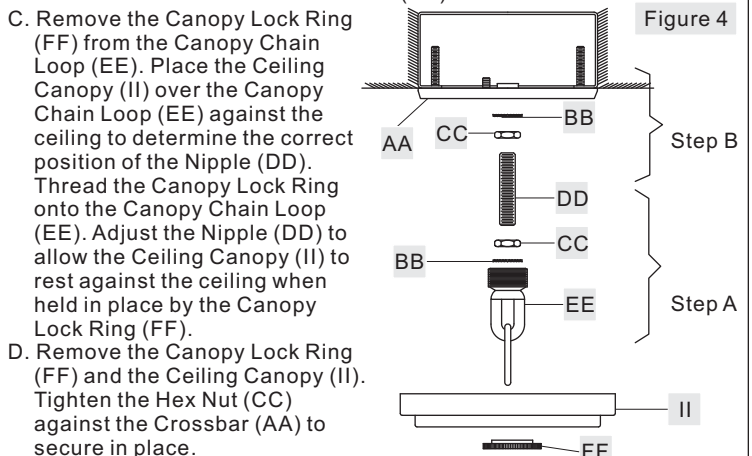

Figure 4

- Remove the Canopy Lock Ring (FF) from the Canopy Chain Loop (EE). Place the Ceiling Canopy (II) over the Canopy Chain Loop (EE) against the ceiling to determine the correct position of the Nipple (DD). Thread the Canopy Lock Ring onto the Canopy Chain Loop (EE). Adjust the Nipple (DD) to allow the Ceiling Canopy (II) to rest against the ceiling when held in place by the Canopy Lock Ring (FF).
- Remove the Canopy Lock Ring (FF) and the Ceiling Canopy (II). Tighten the Hex Nut (CC) against the Crossbar (AA) to secure in place.

Thank you for purchasing a Quoizel product.

Need assistance with parts or assembly? Call Quoizel customer service at 1-631-273-2700 or visit us on-line at www.quoizel.com

STEP 5 - Install Fixture Chain and Ceiling Canopy

- A. Pull the supply wires through the Canopy Lock Ring (FF) and the Ceiling Canopy (HH) in order.
- B. Connect the Fixture Loop (A) to Canopy Chain Loop (EE) by using the Quick Link (GG). The fixture will hang safely now. Close the Quick Link (GG).
- C. Feed the Supply Wires and Ground Wire through the Canopy Chain Loop (EE) and Nipple (DD) into the Outlet Box. Cut the wires leaving approximately 8" of wire extending from the Outlet Box.
- D. Refer to Step 6 for wire connections.
- E. Raise the Ceiling Canopy (HH) and Canopy Lock Ring (FF) up the Quick Link (GG) and over the Canopy Chain Loop (EE). Tighten the Canopy Lock Ring (FF) onto the Canopy Chain Loop (EE) until tight.

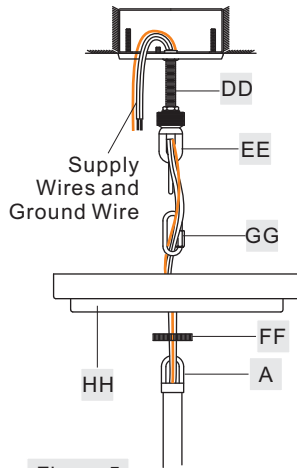

Figure 5

STEP 6 - Wire Connections

- A. Use standard wire connectors (not included) to make all wire connections. (Connectors are not included with fixture.) Twist connectors until wires are tightly joined together. Wrap each connection with approved electrical tape and carefully stuff all the connected wires into outlet box.

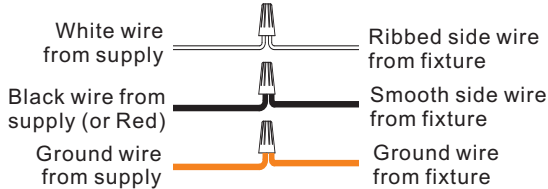

Figure 6

STEP 7 - Install Bulb

- A. This fixture uses standard bulb with standard screw base. Maximum 100 watts. Insert bulb and screw snugly into place.

Your fixture is now assembled and ready to use. Enjoy!

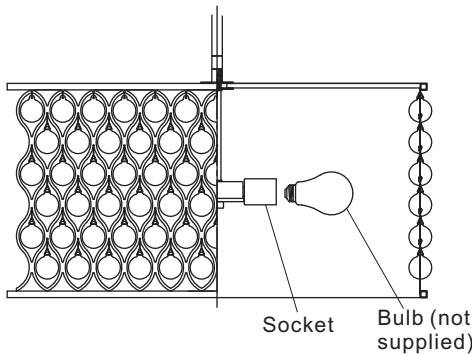
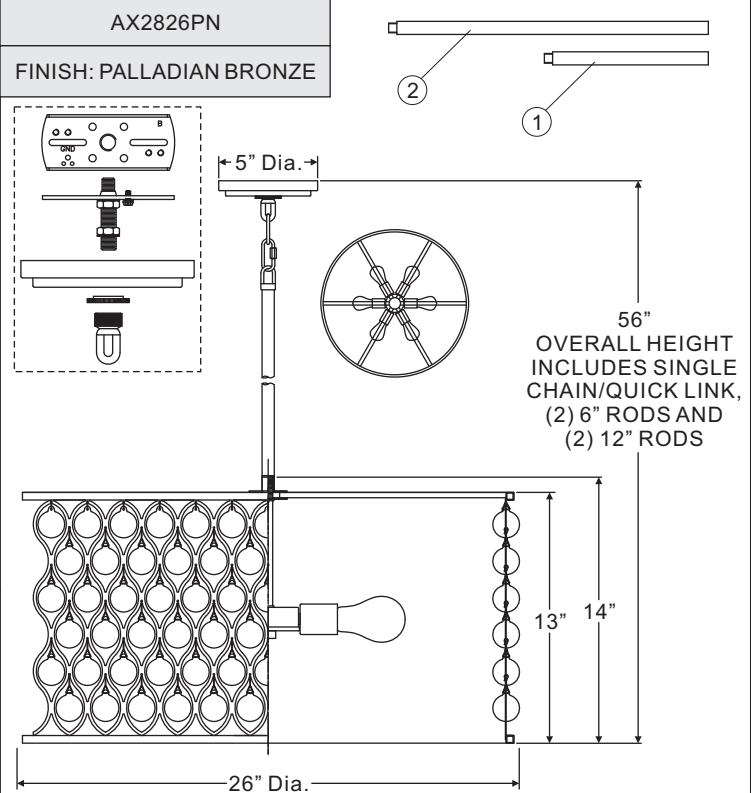

Figure 7



(6) 100W Medium Base Bulbs (Not Supplied)

NOTE: ALL DIMENSIONS ARE ROUNDED UP TO THE NEAREST 1/4"

NO.	PART NUMBER	REPLACEMENT PART	REQ.
1	9007EXPN	6" ROD	2
2	9008EXPN	12" ROD	2

Thank you for purchasing a Quoizel product.
Need assistance with parts or assembly? Call Quoizel customer service at 1-631-273-2700
or visit us on-line at www.quoise.com