

**QUOIZEL**6 CORPORATE PARKWAY  
GOOSE CREEK, SC. 29445  
www. quoizel. comQuoizel, Inc.  
6 Corporate Parkway  
Goose Creek, SC  
29445Customer Service  
Phone 631.273.2700  
Fax 631.231.7102  
[www. quoizel. com](http://www. quoizel. com)

# Assembly Instruction Sheet #IS-WSY5012IF

## For Style WSY5012IF

**Tools Required:** Flathead screwdriver, Phillips screwdriver, pliers, wire cutters, wire strippers, electrical tape, safety glasses.**Bulb Recommended:** (12) Candelabra Base 60W Maximum**Estimated Assembly Time:** 30-45 minutes**Preparation:** Identify and inspect all parts before beginning installation. Check package content list and diagrams below to be sure all parts are present. If any parts are missing or damaged, do not attempt to assemble, install, or operate the fixture. Contact customer service for replacement parts.

### Warnings and Cautions

Turn off electricity at circuit breaker or main fuse box before installation. Consult a licensed electrician if in doubt.

These instructions are provided for your safety. It is very important you read them completely before installing the fixture. We strongly recommend that a licensed, professional electrician perform the installation.

Disconnect fixture from power source before replacing bulbs. Make sure bulbs are given sufficient time to cool before removal. Do not subject glass parts to any shock while in operation or shattering may result.

### Package Contents

Part	Description	Quantity
A	Crossbar	1 pc.
B	Nipple	1 pc.
C	Lock Washer	2 pcs.
D	Hex Nut	2 pcs.
E	Ceiling Canopy	1 pc.
F	Canopy Chain Loop	1 pc.
G	Canopy Lock Ring	1 pc.
H	Fixture Chain	1 pc.
I	Fixture Loop	1 pc.
J	Fixture Body	1 pc.
K	Half Ball D20mm	1 pc.
L	Nipple L1-3/4"	1 pc.
M	Body	1 pc.
N	Cap	1 pc.
O	Half Ball D14mm	1 pc.

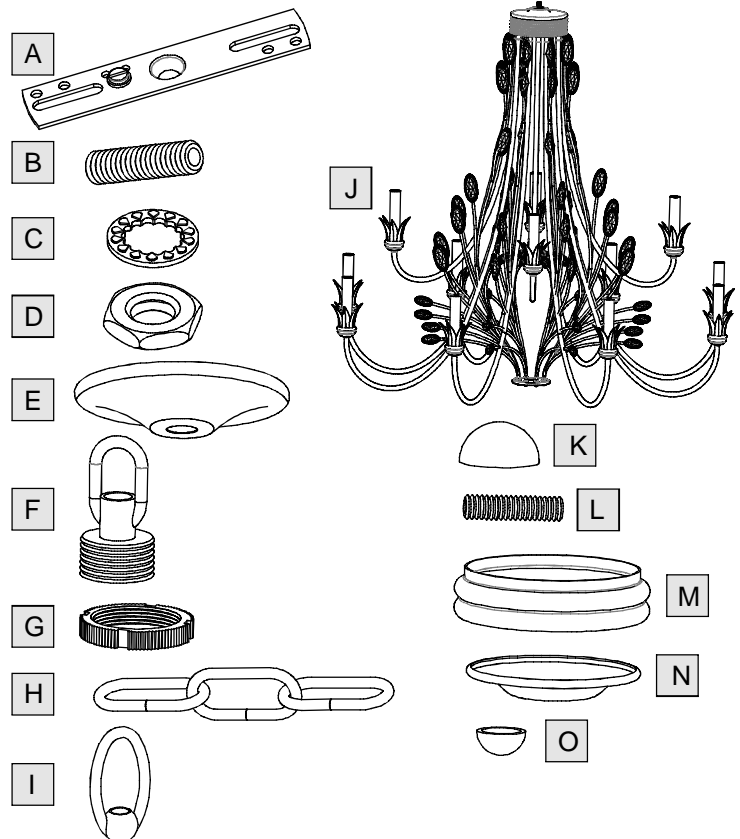

Thank you for purchasing a Quoizel product.

Need assistance with parts or assembly? Call Quoizel customer service at 1-631-273-2700  
or visit us on-line at [www. quoizel. com](http://www. quoizel. com)

WSY5012IF

FINISH: ITALIAN FRESCO

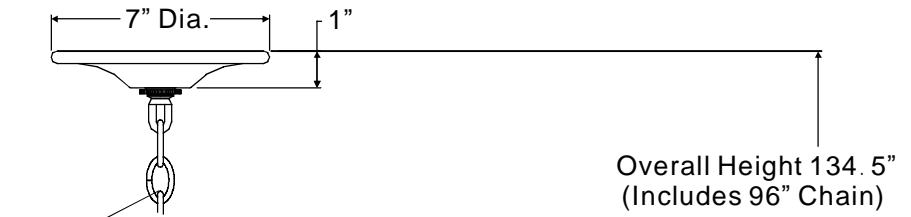
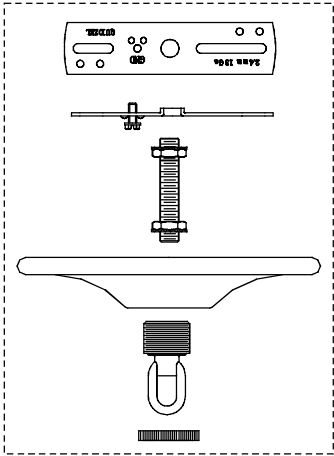

NOTE: FOUR LIGHTS SHOWN FOR ILLUSTRATION PURPOSES ONLY.

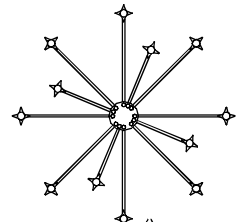
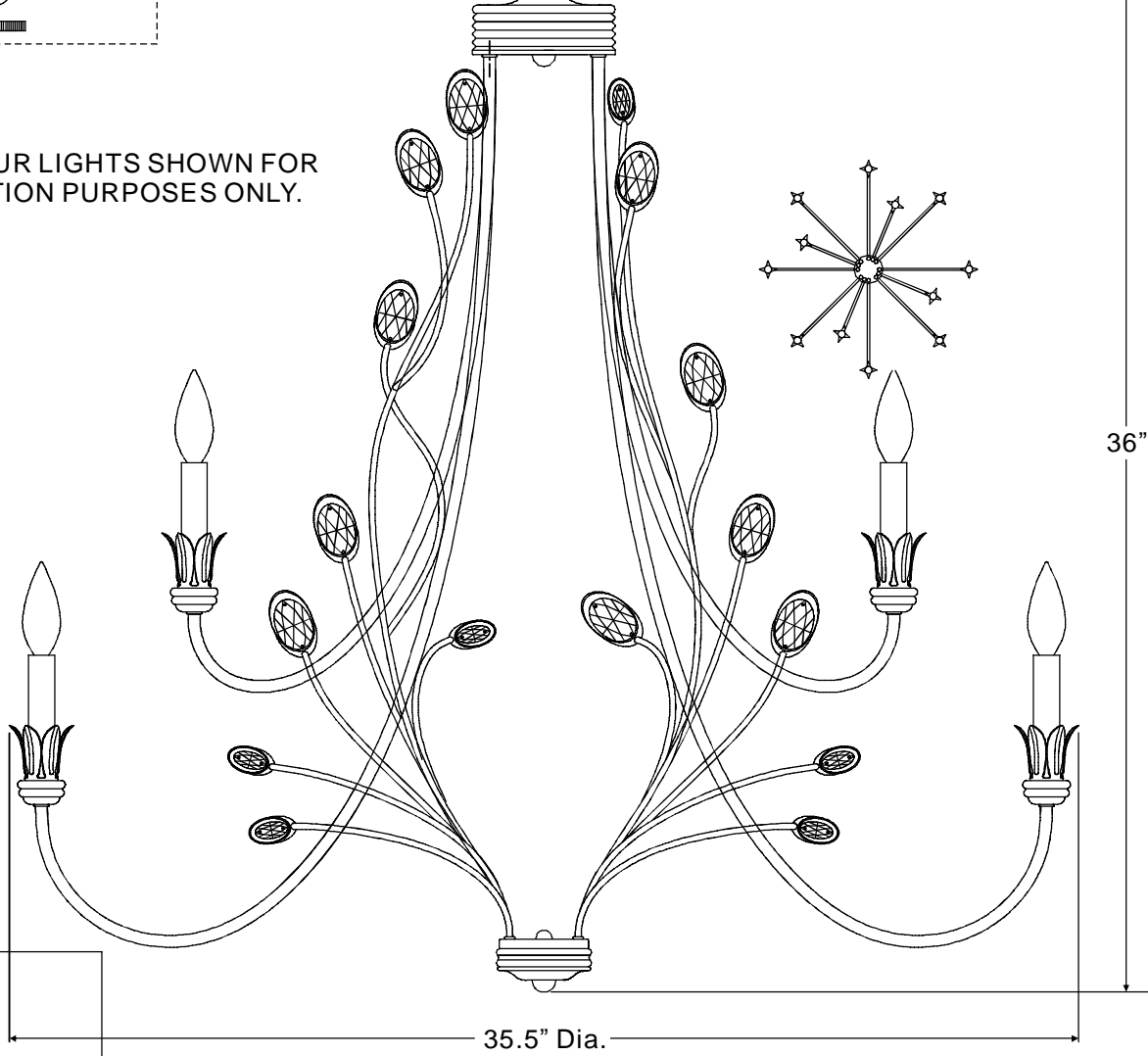

(12) 60W Candelabra Base Bulbs (No Supplied)

NOTE: ALL DIMENSIONS ARE ROUNDED UP TO THE NEAREST 1/2"

NO.	PART NUMBER	REPLACEMENT PART DESCRIPTION	REQ.
1	M2375CHIF	CHAIN ITALIAN FRESCO 3.8MM X 4'	1

# Assembly Instruction Sheet #IS-WSY5012IF

## For Style WSY5012IF

### STEP 1 - Attach Fixture Loop Assembly to Fixture Body

- A. Thread Fixture Loop (I) to Fixture Body (J). Tighten until snug.

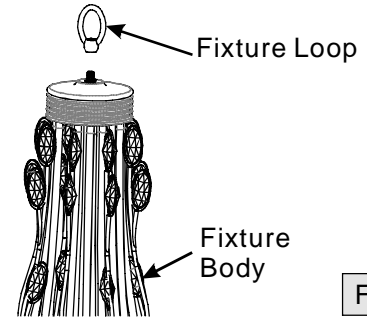

Figure 1

### STEP 2 - Attach Crossbar to Outlet Box

- A. Secure the Crossbar (A) to the outlet box with outlet box screws (not supplied). Tighten until snug.

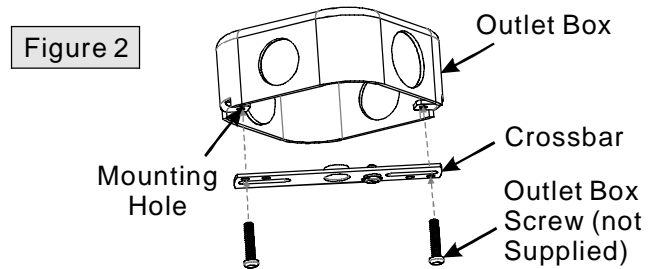

Figure 2

### STEP 3 - Attach Nipple to Crossbar

- A. Thread one Hex Nut (D) onto the top end of the Nipple (B).  
 B. Place one Lock Washer (C) over the top end of the Nipple (B) and then thread the Nipple (B) into the center lock hole of the Crossbar (A).  
 C. Using pliers, thread the hex Nut (D) against the Crossbar (A) and hand tighten until snug.

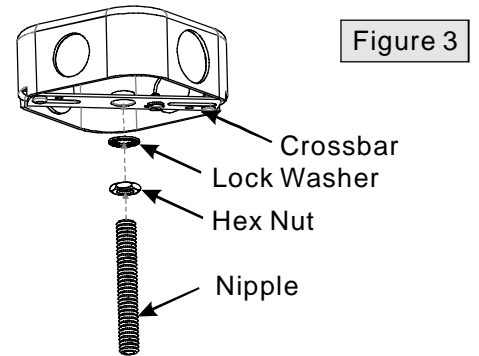

Figure 3

### STEP 4 - Attach Body and Cap to Fixture Body

- A. Thread the Nipple (L) into the Half Ball D14mm (O) and hand tighten until snug. Pass the Nipple (L) through the Plate on the bottom of the fixture, the Body (M) and the Cap (N) in turn. Secure by threading the Half Ball D20mm (K) onto the Nipple (L). Hand tighten until snug.

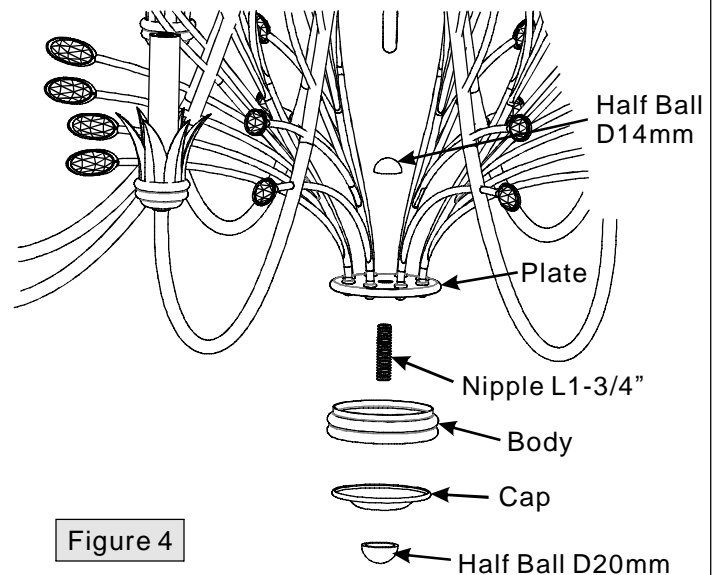

Figure 4

Thank you for purchasing a Quozel product.  
 Need assistance with parts or assembly? Call Quozel customer service at 1-631-273-2700  
 or visit us on-line at [www. quozel. com](http://www. quozel. com)

**STEP 5 - Attach Canopy Chain Loop to Nipple**

- A. Thread another Hex Nut (D) onto the end of the Nipple (B).
- B. Place the Lock Washer (C) over the end of the Nipple (B) and then thread the Canopy Chain Loop (F) onto the end of the Nipple (B).
- C. Using pliers, thread the Hex Nut (D) against the Canopy Chain Loop (F) and hand tighten until snug.

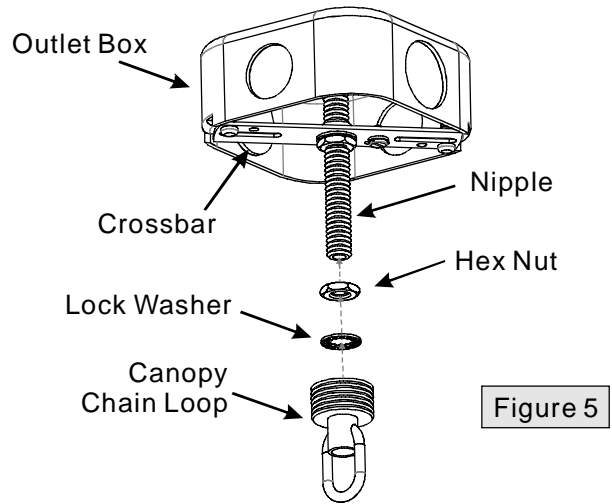

Figure 5

**STEP 6 - Assemble Ceiling Canopy**

- A. Push the Ceiling Canopy (E) upward over the Outlet Box. Thread the Canopy Lock Ring (G) onto the Canopy Chain Loop (F) and tighten until snug to secure the Ceiling Canopy (E).

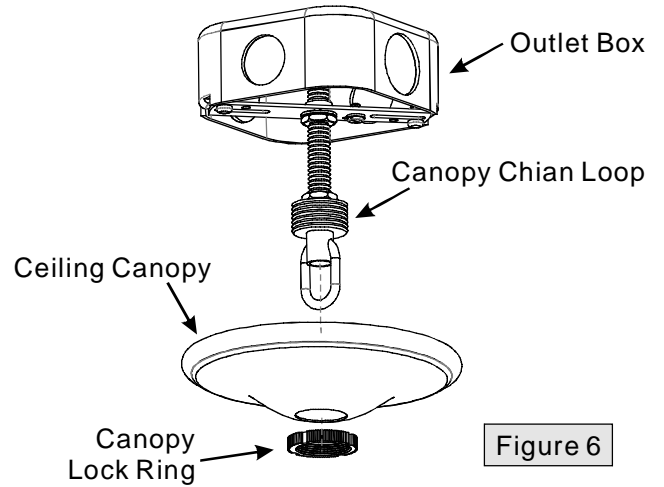

Figure 6

**STEP 7 - Attach Fixture Chain to Canopy Chain Loop and Fixture Loop**

- A. Adjust the Fixture Chain (H) to your desired length by removing the links if needed. You may need to use plier to open the chain links. If so, put a cloth over the chain to protect the finish from the pliers.
- B. Attach one end of the Fixture Chain (H) onto the Canopy Chain Loop (F) and then attach the other end of the Fixture Chain (H) onto the Fixture Loop on the top of the Fixture Loop (I).

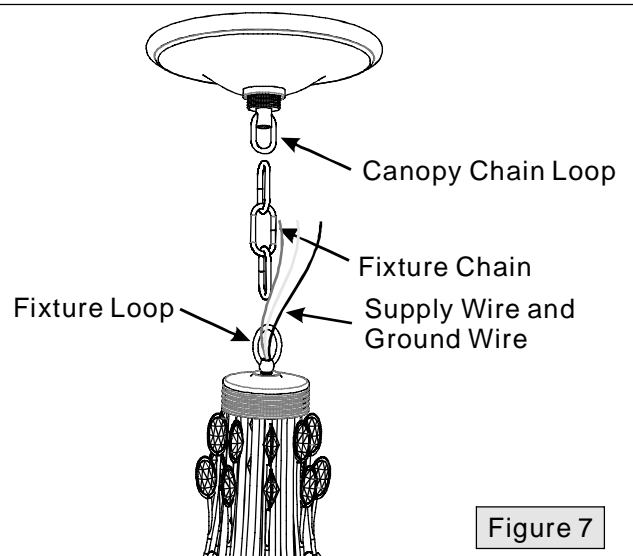

Figure 7

**Thank you for purchasing a Quoizel product.  
Need assistance with parts or assembly? Call Quoizel customer service at 1-631-273-2700  
or visit us on-line at [www. quozel. com](http://www. quozel. com)**

**STEP 8 - Pass Supply Wires through Fixture Chain**

- A. Pull the Supply Wires and Ground Wire up through the Fixture Chain (H) alternating links. Push the wires up through the Canopy Chain Loop (F) into the outlet box.

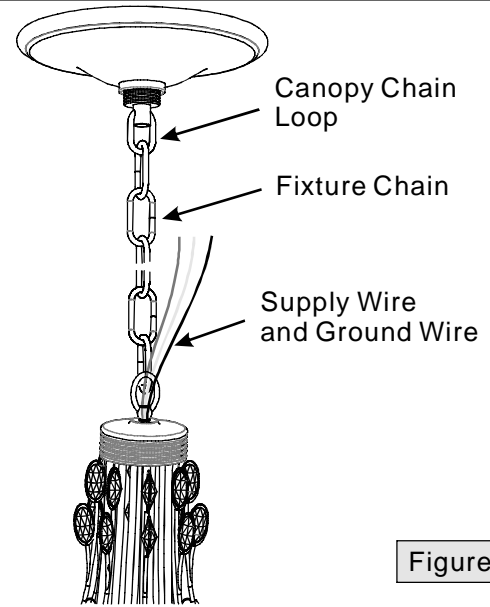

Figure 8

**STEP 9 - Make Wire Connections**

- A. Un-thread the Canopy Lock Ring (G) and slide Canopy Lock Ring (G) and Ceiling Canopy (E) down the Fixture Chain (H).  
 B. Push all slack fixture wire through Canopy Chain Loop (F) into Outlet Box. Trim excess fixture wire leaving a minimum of 7 inch. Hanging out of the Outlet Box.  
 C. Use standard wire connectors to make all wire connections. (Connectors are not included with fixture.) Strip and prepare wire ends according to instructions supplied with connectors.  
 D. Connect White Supply Wire from the Outlet Box to Ribbed side Wire from fixture.  
 E. Connect Black (or Red) Supply Wire from the Outlet Box to Smooth side Wire from fixture.  
 F. Connect Ground Wire from the Outlet Box to Ground Wire from fixture.  
 G. Twist connectors until wires are tightly joined together.  
 H. Wrap each connection with approved electrical tape and carefully stuff all the connected wires into the Outlet Box.  
 I. Re-attach the Ceiling Canopy (E) as shown in Step 6.

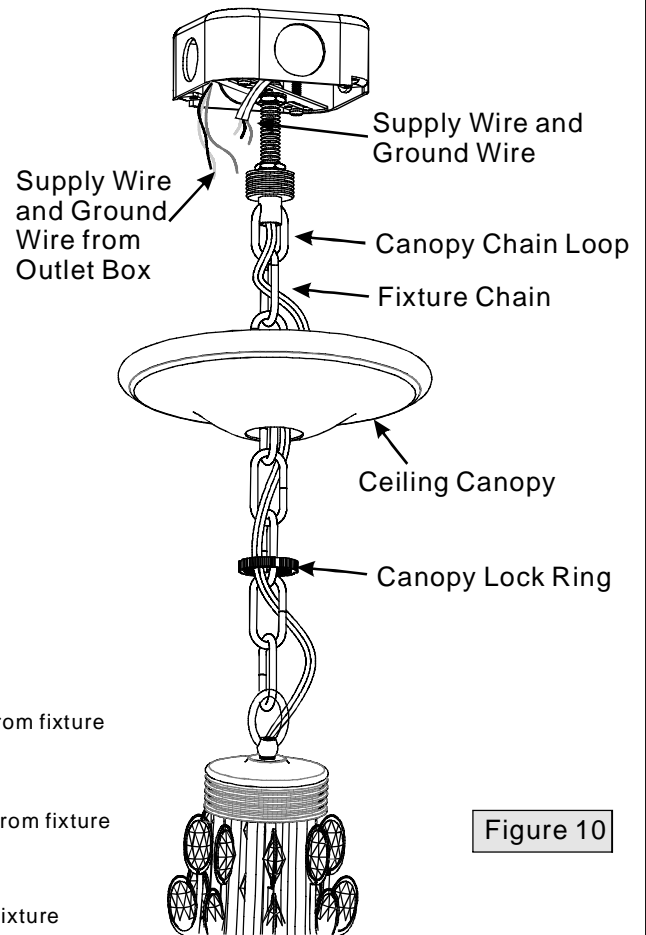

Figure 10

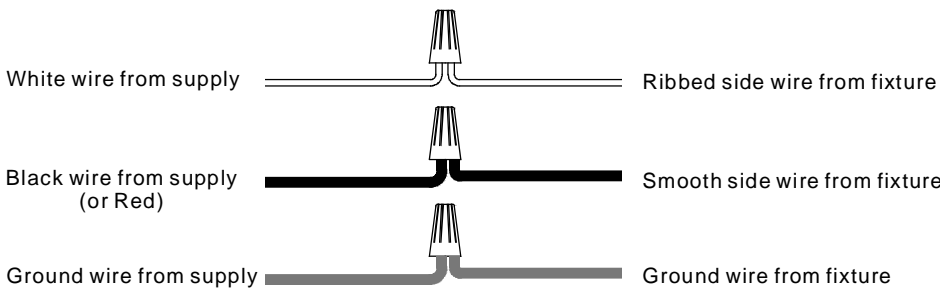

Figure 9

**Thank you for purchasing a Quozel product.  
 Need assistance with parts or assembly? Call Quozel customer service at 1-631-273-2700  
 or visit us on-line at [www. quozel. com](http://www. quozel. com)**

**STEP 10 - Install Bulb**

- A. This fixture uses standard bulbs with a standard screw base. Maximum 60 watts.
- B. Insert bulb and screw properly into place.

Your fixture is now assembled and ready to use.  
Enjoy!

Figure 11

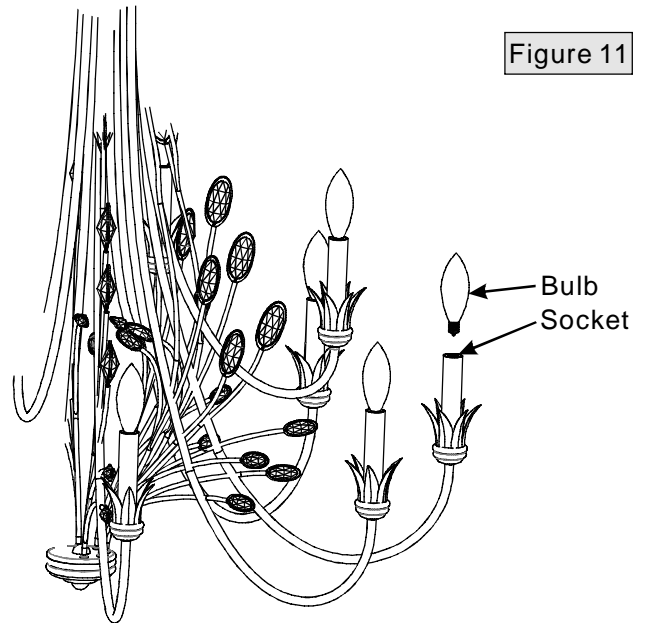

**Thank you for purchasing a Quozel product.**  
**Need assistance with parts or assembly? Call Quozel customer service at 1-631-273-2700**  
**or visit us on-line at [www. quozel. com](http://www. quozel. com)**